



PRICE LIST 2024



FORT By Kinco



SELEC



CONTENTS



Power Capacitors	1 - 3	Temperature Controller & Thermocouple	48-49
Regulator Controller	4	Thermostat & Heater	50
Detune Reactors	4	Protection Relay	51
Active Harmonic Filter	5	Timer, Relay, Counter & Photo Sensor	51-53
Auto Transformer	6	Water Tank Control	54
Reactor For Starting Motors	6	Pressure Pumps Sensor	54
Multi Transformer	7	Limit Switch & Micro Switch	55-58
Motor Starter (3phase)	8	Toggel Switch, Foot Switch & Monolevel Switch	58
Power Supply AC To DC	9-11	Solid State Relay / SSR	59
Power Inverter DC To AC	11	Proximity Sensor	60-61
Battery Charger	11	Photoelectric Sensor	62-63
Generator Controller	12	Buzzer & Motor Siren	64
Transducer	12	Explosion Proof Warning Lamp	65
Power Meter / Digital Multifunction Meter	13	Tower Lamp & Warning Lamp	66-67
AC Digital Panel Meter	14	Industrial Plug & Socket	68-70
DC Digital Panel Meter	15	Terminal Block	71-74
Analog Panel Meter	15 -17	Connector Cable	75
Energy Meter / Kwh Meter	18-19	Busbar Isolators	76
Current Transformer	20-22	Mv Busbar Isolators	77
Indicator Lamp / Led Pilot Lamp	23-25	Busbar Support	77
Command Switch / Control Switch	26-36	Busbar MCB & Rell MCB	78
Control Switch Box	37	Axial Fan	79
Power Push Button	37	Panel Lock & Hinge Distribution Box	80-81
Hoist Push Button	38	Heat Shrink (1kv & 20kv)	82-83
Rotary Swicth	39	Cable Gland	84-86
Cam Switch	40	Lettering Machine / Prinitng Mesin	87
Weather Protection Isolation Swicth	40	Cable Marker & Marker Tube	88
Load Break Switch (LBS)	40-41	Cable Ties, Tie Mounts & Spiral Cable	88-91
Change Over Switch (COS)	41-42	Lasdop / Wire Connectors	92
Automatic Transfer Switch (ATS)	42	Cable Clip	92
LV Fuse	43	Terminal Cabel / Cable Lugs	93-94
MV Fuse	44	Verbending / Connectors Cable	95
Fuse Base	45	Skun Cable KSP	96-100
Fuse Cutout	45	Electrical & Hydraulic Tools	101
Lightning Arrester	45	Copper Busbar Tools	102
Insulation Connector Cable 1kv	46	Earthing & Lightning Product	103
Anchoring Clamp/tension Clamp	47	Explosion - Proof Product	104-107

CONTENTS



Metal & Stainles Steel Panel Box	108-109
Distribution Box	110
Juntion Box	111
MCB Box	112
Cable Chain, Cable Puller & Spring Pipe Bender	113
Decoration Pvc Ducting	114
Wiring Ducts	115
Flexible Conduit & Connectors	116-118
Steel Pipe Conduit & Accessories	119-127



Variable Frequency Drive / Inverter	129-131
Braking Unit & Braking Resistor	130
Human Machine Interface (HMI)	132-133
Programmable Logic Controller (PLC)	134
Servo Motors & Driver	135-136



Digital Power Meter / Digital Multimeter	139-140
Digital AC Meter	141-142
Power Factor Controllers	143
Water Level Controllers	143
Protection Relays	144-147
Timers	148-150
Counters & Rate Indicators	151
Temperature Control & Process	152-153
Process Indicators	153



Low Voltage Reactive ompensation/Filter

Capacitor

More Professional, more comprehensive, always LEADING!

H terminal capacitor adalah produk generasi baru di dunia yang di produksi oleh perusahaan SY dan memiliki beberapa patents untuk struktur dual protection.(Patent number ZL200920052757.X; ZL200920052756.5;ZL200930070501.7)

Capasitor tipe H di gunakan untuk arus yang besar dan kapasitas yang besar, yang artinya kabel 35mm² bisa digunakan. Mengambil struktur perlindungan keselamatan terbaru. Terminal menggunakan struktur blok yang lebih cantik dan penampilan yang lebih halus dan didalam di isi dengan struktur gas, yang stabil dan dapat diandalkan, dengan kemampuan anti inrush yang tinggi terhadap arus saat ini dan dapat memenuhi persyaratan di kelas lingkungan yang lebih tinggi.

Ketika capasitor berjalan di suhu yang berlebihan yang disebabkan oleh harmonisasi jaringan listrik dan tegangan yang berlebihan dll, Di sistem, struktur capasitor ini akan mengeluarkan sinyal kontrol, memutus switch dan masuk ke kondisi proteksi suhu terlampaui, jadi untuk mencegah capasitor dimasukkan ke jaringan listrik sampai lingkungan menurun ke rentang yang dapat diterirna, lalu capasitor dapat beralih ke kondisi kerja. Untuk memperpanjang capasitor dan rentang hidup reaktor dalam kompensasi tanpa setelan dan setelan filter sistem, beberapa capasitor dengan dual protection dapat di pasang seri jadi untuk nnenghindari penyimpangan dari setelan yang disebabkan oleh kegagalan satu atau lebih capasitor, yang akan menyebabkan penguatan arus harmonik tertentu dan menghasilkan kerusakan sistem. dengan bantuan dual protection dari capasitor, kondisi ini akan memaksa secara acak sistem yang gagal untuk tidak berfungsi, sampai pemeliharaan selesai sehingga dapat mencegah kerusakan meluas.

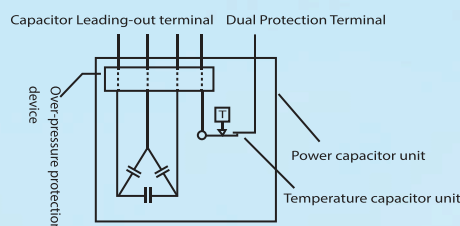

STANDARD

GB/T12747.1-2004 GB/T12747.2-2004	EN60831-1-1998+a1-2003 EN60831-2-1996
IEC 60831-1-2002 IEC60831-2-1995	EIA-456-A-1989
UL810-2008	

TECHNICAL DATA

1. ENVIRONMENT CONDITIONS

Ambient Temperatur	-40/D
Kelembaban	≤ 90 %
Ketinggian	≤ 2000m

2. GENERAL PARAMETERS

Loss	DF ≤ 0.001
Capacity Tolerance	-5% - + 10%
Withstand voltage between terminal and terminal	2.15Un VAC, 5s
Withstand voltage between terminal and case	3600VAC, 2s
Discharge	Less than 75V after disconnection within 3 mins
Sealing performance	90 ± 2 °C 3h, no leakage (oil filled) : Leakage rate <0.55CCM (gas filled)
Safety performance	Has reliable over-pressure and disconnection; meets the requirement of destructive test of IEC60831-2 standard and meet the requirement of UI810 standard's 100000AFC

3. OPERATING PARAMETERS

Maximum overvoltage	1.1Un
Maximum overcurrent	1.3In
Reliability	The failure rate is <6%/0.5%(1ppm component /hour) when products run 60000/5000 hour under rated voltage and nominal temperature. Meet the requirement of the American Electrical Industry Association EIA-456-A

DUAL PROTECTION CAPACITOR

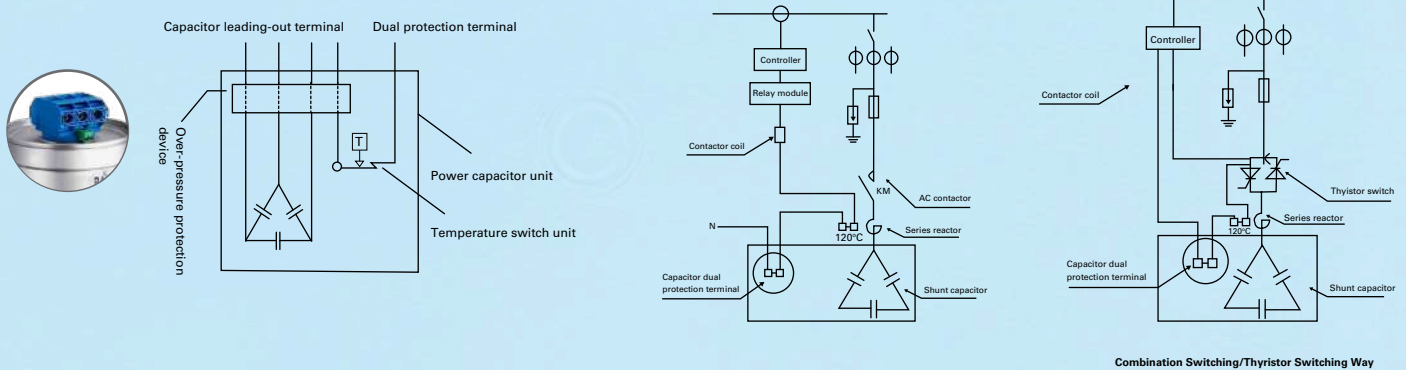

OVERVIEW



European Standard

Silinder sand blasing, Oxidation aluminium perak casing, dengan karakteristik yang bagus untuk menghilangkan panas, ringan, ringkas, dan anti karat.



Quality guarantee

Mengadopsi teknologi paling maju untuk memastikan stabilitas dan konsistensi dari setiap produk



Safety guarantee

SY patent-perlindungan ganda : internal alat pelindung dan pemutus disaat tekanan lebih



Internal Certification

US UL sertifikasi kemandan dan eropa TUV produk sertifikasi



Easy Installation

Tersedia variasi cara kabeling untuk pelanggan tergantung dari masing masing penggunaan

POWER CAPACITORS



Description :

- * 3 Phase Power Capacitors
- * Material dalam tabung adalah Resin oil + Quartz sand, sehingga tahan panas
- * Casing tabung dengan material sand blasing, oxidation aluminium silver
- * Dual protecton / pelindungan ganda : internal alat pelindung dan pemutus disaat tekanan lebih
- * Rated voltage : 415VAC/440VAC/525VAC connection detuned reactor



* Certification :



Rate Volatge	kVar	Capacitance (µF)	Ir Current (A)	Size	Type	Price (Rp)
				(DxH) mm		
415VAC / 50Hz	2,5	46,3	3,5	76 x 175	TMPOSY-415-2.5-3	489.000
	5	92,5	7,0	76 x 240	TMPOSY-415-5-3	524.000
	10	184,9	13,9	86 x 240	TMPOSY-415-10-3	777.000
	15	277,4	20,9	96 x 240	TMPOSY-415-15-3	969.000
	20	369,8	27,8	116 x 240	TMPOSY-415-20-3	1.120.000
	25	462,3	34,8	116 x 285	TMPOSY-415-25-3	1.335.000
	30	554,7	41,7	116 x 285	TMPOSY-415-30-3	1.559.000
	40	739,7	55,6	136 x 285	TMPOSY-415-40-3	2.233.000
	50	925,0	69,6	136 x 285	TMPOSY-415-50-3	2.610.000
440VAC / 50 Hz	2,5	41,1	3,3	76 x 175	TMPOSY-440-2.5-3	524.000
	5	82,2	6,6	76 x 240	TMPOSY-440-5-3	634.000
	10	164,5	13,1	76 x 240	TMPOSY-440-10-3	806.000
	15	246,7	19,7	96 x 240	TMPOSY-440-15-3	1.047.000
	20	329,0	26,3	106 x 240	TMPOSY-440-20-3	1.267.000
	25	411,2	32,8	106 x 240	TMPOSY-440-25-3	1.467.000
	30	493,5	39,4	116 x 285	TMPOSY-440-30-3	1.689.000
	40	658,0	52,5	136 x 285	TMPOSY-440-40-3	2.467.000
	50	823,0	65,6	136 x 285	TMPOSY-440-50-3	2.777.000
525VAC / 50 Hz	20	231,1	22,0	106 x 240	TMPOSY-525-20-3	1.519.000
	25	288,9	27,5	116 x 240	TMPOSY-525-25-3	1.857.000
	30	346,6	33,0	116 x 285	TMPOSY-525-30-3	1.943.000
	40	462,2	44,0	136 x 285	TMPOSY-525-40-3	2.652.000
	50	578,0	55,0	136 x 285	TMPOSY-525-50-3	3.019.000

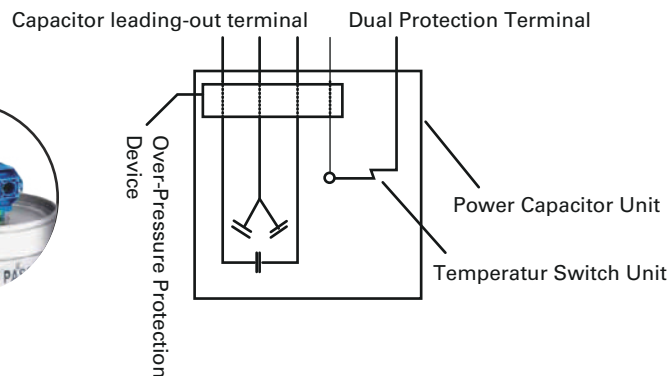



POWER FACTOR CONTROLLER



Description	Size	Output Relay	Type	Price (Rp)
Power Factor Controller * LED display, 4 digits * Single CT sensing * Automatic program	144 X 144	6 step	FRG-6T	1.779.000
		8 step	FRG-8T	1.900.000
		12 step	FRG-12T	2.200.000

CAPACITORS SWITCHING CONTACTOR



Rate Thermal Current (A)	Kvar / Ampere	Type	Aux Contact	Price (Rp)
25	12 / 17	HDC19s-25	1NO 1NC	Harga ada di price list himel
32	20 / 29	HDC19s-32	1NO 1NC	
43	25 / 36	HDC19s-43	1NO 1NC	
63	30 / 43	HDC19s-63	2NO 1NC	
95	50 / 72	HDC19s-95	2NO 1NC	
115	60 / 87	HDC19s-115	2NO 1NC	

Note : * Coil contact : 220VAC, 50/60Hz

DETUNED REACTOR FOR CAPACITORS



Description :

- * Working Voltage : 3Phase / 525 VAC
- * Rate Inductance : 1.5nH + 5%
- * Temperature Rising : Wire temperature rising 1.35 time rate current (Resistance method to test) < 95K
- * Noise : < 48dB
- * Insulation : H Class
- * Linearity : 1.4 In, Rate inductance : ≥ 0.95Ln
- * Detuning : 7.0%

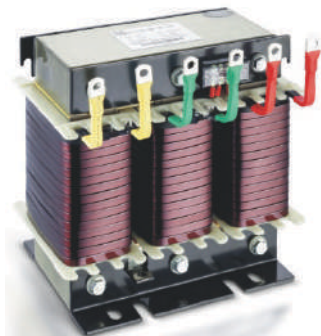

Voltage	kVar	Type	Price (Rp)
525VAC / 50Hz	20	LCSY 525-20/7.0	2.849.000
	25	LCSY 525-25/7.0	3.213.000
	30	LCSY 525-30/7.0	3.274.000
	40	LCSY 525-40/7.0	3.880.000
	50	LCSY 525-50/7.0	4.729.000
440VAC / 50Hz	20	LCSY 440-20/7.0	3.003.000
	25	LCSY 440-25/7.0	3.349.000
	30	LCSY 440-30/7.0	3.580.000
	40	LCSY 440-40/7.0	4.273.000
	50	LCSY 440-50/7.0	5.082.000



ACTIVE HARMONIC FILTER



Price List per 1 April 2026



Wall Mounting Active Harmonic Filter (3Phase, 4 Wire), THDu< 15%

Type	Rating Capacity (A)	Voltage	Dimension (mm)	Price List (Rp)
SYICD-APF0.4/35-3P4L-BD	35	380VAC /50Hz	378*525*200	60,274,000
SYICD-APF0.4/50-3P4L-BD	50		378*525*200	65,274,000
SYICD-APF0.4/75-3P4L-BD	75		418*556*200	73,828,000
SYICD-APF0.4/100-3P4L-BD	100		503*611*232	96,494,000
SYICD-APF0.4/150-3P4L-BD	150		573*621*250	125,200,000
SYICD-APF0.4/200-3P4L-BD	200		694*680*250	189,994,000



Drawer/Rack Mounted Active Harmonic Filter (3Phase, 4 Wire), THDu< 15%

Type	Rating Capacity (A)	Voltage	Dimension (mm)	Price List (Rp)
SYICD-APF0.4/35-3P4L-CD	35	380VAC /50Hz	359*538*200	60,274,000
SYICD-APF0.4/50-3P4L-CD	50		359*538*200	65,274,000
SYICD-APF0.4/75-3P4L-CD	75		399*626*200	73,828,000
SYICD-APF0.4/100-3P4L-CD	100		484*624*232	96,494,000
SYICD-APF0.4/150-3P4L-CD	150		554*634*250	125,200,000
SYICD-APF0.4/200-3P4L-CD	200		674*715*250	189,994,000



Cabinet Type Active Harmonic Filter (3Phase, 4 Wire), THDu< 15%

Type	Rating Capacity (A)	Voltage	Module	Dimension (mm)	Price List (Rp)
SYICD-APF0.4/200-3P4L-A	200	380VAC /50Hz	2*100A module	800*1000*2200	349,000,000
SYICD-APF0.4/250-3P4L-A	250		1*150A + 1*100A module	800*1000*2200	350,000,000
SYICD-APF0.4/300-3P4L-A	300		2*150A module	800*1000*2200	410,000,000
SYICD-APF0.4/400-3P4L-A	400		2*150A + 1*100A module	800*1000*2200	514,000,000
SYICD-APF0.4/500-3P4L-A	500		2*150A + 2*100A module	800*1000*2200	630,000,000
SYICD-APF0.4/600-3P4L-A	600		4*150A module	800*1000*2200	706,000,000



Price List 2024

AUTO TRANSFORMER

for starting motors 3phase



Description :

- * Working Voltage : 3Phase / 380 VAC, 50Hz
- * Material : Full Copper 99.9%
- * Insulation Temperature : 155°C or Class F - 1PEW Polyester enamelled copper wire
- * Temperature Safety Protection with thermostat



22kW - 75kW



95kW - 225kW

Motor 380V / 50Hz		Type	Tappings (%)	Insulation Class	Dimension (mm)	Price (Rp)
KW	HP		% Input Vol.			
22	30	MH-22KW	40%, 50%, 60%, 75%	F	264*200*260	6.549.000
30	40	MH-30KW	40%, 50%, 60%, 75%	F	264*210*260	6.946.000
37,5	50	MH-37.5KW	40%, 50%, 60%, 75%	F	264*220*260	8.983.000
45	60	MH-45KW	40%, 50%, 60%, 75%	F	300*230*300	11.518.500
55	75	MH-55KW	40%, 50%, 60%, 75%	F	300*230*320	12.705.000
75	100	MH-75KW	40%, 50%, 60%, 75%	F	360*350*330	14.385.000
95	125	MH-95KW	55%, 65%, 75%	F	360*360*360	16.695.000
110	150	MH-110KW	55%, 65%, 75%	F	360*360*360	16.905.000
132	175	MH-132KW	55%, 65%, 75%	F	360*360*360	21.556.500
150	200	MH-150KW	55%, 65%, 75%	F	360*360*360	23.624.000
180	250	MH-180KW	55%, 65%, 75%	F	420*400*410	28.240.800
200	268	MH-200KW	55%, 65%, 75%	F	420*420*410	30.813.000
225	300	MH-220KW	55%, 65%, 75%	F	420*440*410	32.862.900

REACTOR FOR STARTING MOTORS

Description :

- * Working Voltage : 3Phase / 380-440VAC, 50Hz
- * Material : Full Copper 99.9%
- * Insulation Temperature : 65°C or Class F
- * Temperature Safety Protection with thermostat



Motor 380V / 50Hz		Type	Rate Current (A)	Inductance (L)	Dimension (mm)	Price (Rp)
KW	HP					
5,5	7,5	FACL-15/5.5	15	1,953	155*130*140	2.079.000
7,5	11	FACL-20/7.5	20	1,464	155*130*140	2.229.000
11	15	FACL-30/11	30	0,976	155*140*140	2.530.500
15	18,5	FACL-40/15	40	0,732	155*140*140	2.823.000
18,5	22	FACL-50/18.5	50	0,586	175*160*140	4.012.000
22	30	FACL-60/22	60	0,488	175*160*140	4.162.000
30	40	FACL-80/30	80	0,366	200*160*170	4.548.600
37,5	50	FACL-110/37	110	0,266	240*150*190	4.934.000
45	60	FACL-125/45	125	0,234	240*150*190	5.132.000
55	75	FACL-150/55	150	0,195	240*165*190	5.455.000

MULTI TRANSFORMER

STEP - DOWN



Description :

- * Input Voltage : 380/220 VAC, 50/60Hz
- * Output Volatge : Multiple
- * Material : Full Copper 99.9%
- * Insulation Class : B

Capacity	Input Voltage (VAC)	Output Voltage (VAC)	Connection	Type	Price / Unit (Rp)
63 VA	380/220V	220V/110V/48V	Terminal Block	FT-JK63 - 220	327.000
		36V/24V/12V	Terminal Block	FT-JK63 - 36	
100 VA	380/220V	220V/110V/48V	Terminal Block	FT-JK100 - 220	384.000
		36V/24V/12V	Terminal Block	FT-JK100 - 36	
160 VA	380/220V	220V/110V/48V	Terminal Block	FT-JK160 - 220	544.000
		36V/24V/12V	Terminal Block	FT-JK160 - 36	
200 VA	380/220V	220V/110V/48V	Terminal Block	FT-JK200 - 220	672.000
		36V/24V/12V	Terminal Block	FT-JK200 - 36	
250 VA	380/220V	220V/110V/48V	Terminal Block	FT-JK250 - 220	715.000
		36V/24V/12V	Terminal Block	FT-JK250 - 36	
300 VA	380/220V	220V/110V/48V	Terminal Block	FT-JK300 - 220	799.000
		36V/24V/12V	Terminal Block	FT-JK300 - 36	
400 VA	380/220V	220V/110V/48V	Terminal Block	FT-JK400 - 220	1.107.000
		36V/24V/12V	Terminal Block	FT-JK400 - 36	
500 VA	380/220V	220V/110V/48V	Terminal Block	FT-JK500 - 220	1.265.000
		36V/24V/12V	Terminal Block	FT-JK500 - 36	
700 VA	380/220V	220V/110V/48V	Terminal Block	FT-JK700 - 220	1.858.000
		36V/24V/12V	Terminal Block	FT-JK700-36	
800 VA	380/220V	220V/110V/48V	Terminal Block	FT-JK800 - 220	1.989.000
		36V/24V/12V	Terminal Block	FT-JK800-36	
1000 VA	380/220V	220V/110V/48V	Terminal Block	FT-JK1000 - 220	2.489.000
		36V/24V/12V	Terminal Block	FT-JK1000 - 36	



MOTOR STARTER (3PHASE)

DOL STARTER



Metal BOX



Motor Operation 380/440VAC		Coil Voltage (VAC)	Type	Ampere Setting (A)	Price (Rp)
kW	Hp				
0,37	0,75	380/220	MSN-10	1.0 - 1.6	289.800
0,75	1			1.4 - 2.0	
1,1	1,5			1.7 - 2.5	
1,5	2			2.8 - 4.4	
2,2	3			4.0 - 6.0	
3,7	5			7.0 - 11.0	
5,5	7,5	380/220	MSN-20	9.0 - 13.0	453.600
7,5	10			12 - 18	
11	15	380/220	MSN-25	18 - 26	562.000
15	20			24 - 34	
19	25			30 - 40	

Plastic / ABS BOX



Motor Operation 380/440VAC		Coil Voltage (VAC)	Type	Ampere Setting (A)	Price (Rp)
kW	Hp				
0,37	0,75	380/220	GMW-X2-12	1.0 - 1.6	315.000
0,75	1			1.4 - 2.0	
1,1	1,5			1.7 - 2.5	
1,5	2			2.8 - 4.4	
2,2	3			4.0 - 6.0	
3,7	5			7.0 - 11.0	
5,5	7,5	380/220	GMW-X2-18	9.0 - 13.0	327.600
7,5	10			12 - 18	
11	15	380/220	GMW-X2-32	18 - 22	527.000
15	20			23 - 32	

Box For DOL Starter With Push Button



Description	Price (Rp)
For MSN 10PM / MS-N11	100.000
For MSN 20PM / MS-N21	125.000
For MSN 35PM / MS-N35	193.000

POWER SUPPLY

AC to DC Voltage



S - 15

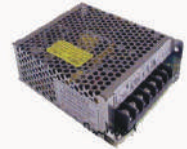

S - 50



S-240



S-320 / S-350



SP-500/600



SCN-1000

Description	Output Voltage (VAC)	Output Ampere (A)	Type	Price / Unit (Rp)
Single Output	5	3	S - 15 - 5	173.000
		7	S - 35 - 5	209.000
		10	S - 50 - 5	256.000
		20	S - 100 - 5	309.000
		40	S - 200 - 5	529.000
	12	1,3	S - 15 - 12	173.000
		3	S - 35 - 12	209.000
		4,2	S - 50 - 12	256.000
		8,5	S - 100 - 12	309.000
		12	S - 145 - 12	356.000
		18	S - 240 - 12	556.000
		25	S - 320 - 12	665.000
	15	29	S - 350 - 12	665.000
		40	SP - 500 - 12	1.928.000
		1	S - 15 - 15	173.000
		2,2	S - 35 - 15	209.000
		3,4	S - 50 - 15	256.000
		6,6	S - 100 - 15	309.000
	24	9,5	S - 145 - 15	356.000
		13	S - 200 - 15	529.000
		0,7	S - 15 - 24	173.000
		1,5	S - 35 - 24	209.000
		2,1	S - 50 - 24	256.000
		4,5	S - 100 - 24	309.000
		6	S - 145 - 24	356.000
		8,3	S - 201 - 24	529.000
		10	S - 240 - 24	556.000
		14,6	S - 350 - 24	665.000
48	20	SP - 500 - 24	1.928.000	
	25	SP - 600 - 24	2.414.000	
	33	SCN - 800 - 24	4.505.000	
	41,5	SCN - 1000 - 24	5.250.000	
	2	S-100-48	309.000	
	4,2	S-201-48	529.000	
	7,3	S-350-48	665.000	
	10	SP-500-48	1.928.000	
	12,5	SP-600-48	2.414.000	

POWER SUPPLY

AC to DC Voltage



Description	Output Voltage (Vdc)	Output Ampere (A)	Type	Price (Rp)
Triple Output	- 5, + 5, 12	0.5 , 5 , 2.5	T-60-A/U1	488.000
	5, -12, + 12	3 , 0.5 , 2	T-40-B/U2	380.000
	5, -12, + 12	5 , 0.5 , 2.5	T-60-B/U2	488.000
	5, -15, + 15	5 , 0.5 , 2.5	T-60-C/U3	765.000
	5, -15, + 15	10 , 1 , 2.5	T-100C/T-120-C	787.000
	5, 12, 24	10 , 2 , 1	T-100D/T-120-D	787.000
Quant Group Output	5V, -5V, 15V, -15V	10 , 1 , 3.5 , 1	Q-120-U3	900.000
	5V, -5V, 12V, -12V	13 , 1 , 2 , 1	Q-100-U2	871.000
	5V, -12V, 12V, 24V	10 , 1 , 2 , 5	Q-180-U4	1.500.000

DIN RAIL POWER SUPPLY

AC to DC Voltage



Description	Model	Output Voltage (Vdc)	Output Ampere (A)	Type	Price (Rp)
Single Output	Plastic ABS	5	3	DR-30-5	590.000
			6,5	DR-60-5	610.000
		12	2,0	DR-30-12	590.000
			5	DR-60-12	610.000
		24	2,5	DR-60-24	610.000
* Single Output * Input (100-240VAC)	Metal / Iron	12	6,3	NDR-75-12	476.000
			10,0	NDR-120-12	525.000
			12,5	NDR-150-12	546.000
		24	3,2	NDR-75-24	476.000
			5,0	NDR-120-24	525.000
			6,5	NDR-150-24	546.000
			10,0	NDR-240-24	1.120.000

MINI SWITCHING POWER SUPPLY AC to DC Voltage



Description	Output Voltage (Vdc)	Output Ampere (A)	Type	Price (Rp)
Single Output	5	4	SF-20-5	185.000
		7	SF-35-5	214.000
		10	SF-50-5	297.000
		20	SF-100-5	410.000
	12	2,0	SF-20-12	185.000
		3	SF-35-12	214.000
		4,0	SF-50-12	297.000
		6,0	SF-70-12	355.000
		10	SF-120-12	420.000
	24	1,5	SF-35-24	214.000
		2,0	SF-50-24	297.000
		3,0	SF-70-24	355.000
5,0		SF-120-24	420.000	

POWER INVERTER DC to AC Voltage



Input	Specification	Output	Type	Price (Rp)
12VDC	220VAC	300 W	GK-DZ-300-12	1.230.000
		500 W	GK-DZ-500-12	1.983.000
		800 W	GK-DZ-800-12	2.803.000
		1000 W	GK-DZ-1000-12	2.939.000
		1500 W	GK-DZ-1500-12	4.158.000
		2000 W	GK-DZ-2000-12	5.683.000
		2500 W	GK-DZ-2500-12	6.210.000
		3000 W	GK-DZ-3000-12	8.316.000
		4000 W	GK-DZ-4000-12	11.504.000
24VDC	220VAC	300 W	GK-DZ-300-24	1.230.000
		500 W	GK-DZ-500-24	1.983.000
		800 W	GK-DZ-800-24	2.803.000
		1000 W	GK-DZ-1000-24	2.939.000
		1500 W	GK-DZ-1500-24	4.158.000
		2000 W	GK-DZ-2000-24	5.683.000
		2500 W	GK-DZ-2500-24	6.210.000
		3000 W	GK-DZ-3000-24	8.316.000
		4000 W	GK-DZ-4000-24	11.504.000

BATTERY CHARGER



Description	Type	Price (Rp)
* Electronic Auto System Charging * Mounting : Din-rail / Screw * Input Voltage : 220VAC/50Hz * Double Output Voltage : 12/24 VDC	FBC-1224-5 (5A)	882.000
	FBC-1224-10 (10A)	1.050.000
* Electronic Auto System Charging * Mounting : Din-rail / Screw * Input Voltage : 100 - 240VAC/50Hz	FBC-1224M	890.000

GENERATOR CONTROLLER



Description	Type	Price (Rp)
Genset Auto Start Modul * Power supply : 8 - 35VDC * Input Voltage : 15 - 360VAC (L-N), Single Phase * Setting Communication Software by USB port * Operating : Manual/Automatic Start-Stop * Dimension : Frame size : 97mm x 78mm x 44mm > Frame size : 97mm x 78mm x 44mm > Panel cutout : 78mm x 66mm	LXC-706	1.830.000
AMF Controller * Power supply : 8 - 35VDC * Input Voltage : > 15 - 360VAC (L-N), 1phase 2 wire, 2phase 3wire, 3phase 4 wire > 30 - 620VAC (L-L), 3phase 3 wire * CT secondary current : 5A * Control protection : Auto Start/Stop, Switch ON/OFF (ATS control) and fault display * Setting Communication Software by USB port * Dimension : > Frame size : 143mm x 115mm x 41mm > Panel cutout : 110mm x 90mm	LXC-3120	2.791.000
AMF Controller * Power supply : 8 - 35VDC * Input Voltage : > 15 - 360VAC (L-N), 1phase 2 wire, 2phase 3wire, 3phase 4 wire > 30 - 620VAC (L-L), 3phase 3 wire * CT secondary current : 5A * Control protection : Auto Start/Stop, Switch ON/OFF (ATS control) and fault display * Communication Software via : USB, RS232, RS485 modbus protocol GPRS interface * Dimension : > Frame size : 210mm x 152mm x 46mm > Panel cutout : 186mm x 141mm	LXC-6120E	4.600.000

TRANSDUCER



Description	Input	Output	Type	Price (Rp)
AC CURRENT TRANSDUCER * Power Supply : 80-270AC/DC * Compressive strength : AC2kVrms/min * Insulation resistance: >100MΩ at DC500V * Response time : ≤400ms * Accuracy/Class : 0.2% * Installation method : Din-Rail & Screw	Current : 0-5A AC	Current : 4-20mA DC	FYB-A1-mA	1.275.000
	Current : 0-5A AC	Voltage : 0-10 VDC	FYB-A1-V	1.275.000
AC VOLTAGE TRANSDUCER * Power Supply : 80-270AC/DC * Compressive strength : AC2kVrms/min * Insulation resistance: >100MΩ at DC500V * Response time : ≤400ms * Accuracy/Class : 0.2% * Installation method : Din-Rail & Screw	Voltage : 0-400VAC	Current : 4-20mA DC	FYB-V1-mA	1.275.000
	Voltage : 0-400VAC	Voltage : 0-10 VDC	FYB-V1-V	1.275.000

POWER METER / DIGITAL MULTIFUNCTION METER



Description	Type	Price (Rp)
3Phase AC LED Digital Multimeter Measurement function : V, A, Hz * 3Phase/4wire * Voltage range : 0-450VAC * Ampere range : 0-9999/5A/1A * Frequency range : 45-65Hz * Operating power : 200-240VAC * Size : 96*96	FCN300-3AV4-5 / FT96-3VAF	565.000
3Phase AC LCD Digital Multimeter/Power Meter Measurement function : V, A, Hz, kW, Kwh, kVar, kVA, Cos Ø, kVarh, kVah * Communication via Modbus RS485 * 3Phase/4wire * Voltage range : 0-450VAC * Ampere range : 0-9999/5A/1A * Frequency range : 45-65Hz * Operating power : 200-240VAC * Size : 96*96	FCN300-3E4Y	887.000
3Phase AC LCD Digital Multimeter/Power Meter Measurement function : V, A, Hz, kW, Kwh, kVar, kVA, Cos Ø, kVarh, kVah, Harmonic * Communication via Modbus RS485 * 3Phase/4wire * Voltage range : 0-450VAC * Ampere range : 0-9999/5A/1A * Frequency range : 45-65Hz * Operating power : 200-240VAC * Size : 96*96	FCN300-3EH4Y	1.400.000

AC DIGITAL PANEL METER



Digital Volt Meter



Description	Size	Type	Price (Rp)
AC Digital Voltmeter, 1display * For Sigle phase	96 X 96	FT-96VD	235.000
	72 X 72	FT-72VD	235.000
AC Digital Voltmeter, 3 display * For 3 phase	96 X 96	FT-96VD3	540.000
	72 X 72	FT-72VD3	540.000

Digital Amper Meter



Description	Size	Type	Price (Rp)
AC Digital Ampermeter, 1display * For Sigle phase	96 X 96	FT-96AD	235.000
	72 X 72	FT-72AD	235.000
AC Digital Ampermeter, 3 display * For 3 phase	96 X 96	FT-96AD3	540.000
	72 X 72	FT-72AD3	540.000

Digital Power Factor Meter



Description	Size	Type	Price (Rp)
AC Digital Cos Q meter, 1 display X 4 digit	96 X 96	FT-96PFD	632.000
	72 X 72	FT-72PFD	632.000

Digital Frequency Meter



Description	Size	Type	Price (Rp)
AC Digital HZ meter, 1 display X 4 digit	96 X 96	FT-96HD	235.000
	72 X 72	FT-72HD	235.000

Digital Watt Meter



Description	Size	Type	Price (Rp)
AC Digital Watt meter, 1 Display X 4 digit * 3Phase/3Wire, 415VAC	96 X 96	FT-96WD	1.173.000
	72 X 72	FT-72WD	1.173.000

Digital Multi Meter (V,A, HZ)



Description	Size	Type	Price (Rp)
AC Digital Multimeter (V, A, Hz) * For Sigle phase * For 3 phase by selector swith	96 X 96	FT-96VAHZ	540.000
	72 X 72	FT-72VAHZ	540.000

ANALOG PANEL METER

AC / DC



Amper Meter



Ampere Range	Price (Rp)		
	FT-45A (50x50)	FT-52A (60x60)	FT-65A (80x80)
0 - 5A, AC/DC	49.600	53.600	62.000
0 - 10A, AC/DC			
0 - 15A, AC/DC			
0 - 20A, AC/DC			
0 - 30A, AC/DC			
0 - 40A, AC/DC			
0 - 50A, AC/DC			
0 - 100mA, AC/DC			
0 - 300mA, AC/DC			
0 - 500mA, AC/DC			

Volt Meter



Ampere Range	Price (Rp)		
	FT-45V (50x50)	FT-52V (60x60)	FT-65V (80x80)
0 - 15V, AC/DC	49.600	53.600	62.000
0 - 30V, AC/DC			
0 - 50V, AC/DC			
0 - 150V, AC/DC			
0 - 300V, AC/DC			
0 - 500V, AC/DC			

DC DIGITAL PANEL METER



Description	Size	Type	Price (Rp)
Digital DC Voltmeter *Single phase *1 display *Maximum 600VDC	96 X 96	FT96 - VDC	365.000
	72 X 72	FT72 - VDC	365.000
	48 X 96	FT48 - VDC	365.000
Digital DC Ampermeter *Single phase *1 display *by shunt 300A DC/75mV *Maximum 300A DC	96 X 96	FT96 - ADC	365.000
	72 X 72	FT72 - ADC	365.000
	48 X 96	FT48 - ADC	365.000

ANALOG AC PANEL METER



Amper Meter VIA CT /5A class: 1.5



Type	Range Ampere	Size	Price (Rp)
FT-96A	0 - 30A/60A	96 X 96	77.700
	0 - 50A/100A		
	0 - 60A/120A		
	0 - 75A/150A		
	0 - 100A/200A		
	0 - 150A/300A		
	0 - 200A/400A		
	0 - 250A/500A		
	0 - 300A/600A		
	0 - 400A/800A		
	0 - 500A/1000A		
	0 - 600A/1200A		
	0 - 800A/1600A		
	0 - 1000A/2000A		
	0 - 1200A/2400A		
	0 - 1600A/3200A		
	0 - 2000A/4000A		
	0 - 2500A/5000A		
	0 - 3000A/6000A		
	0 - 4000A/8000A		
0 - 5000A/10000A			
0 - 6000A/12000A			
FT-72A	0 - 30A/60A	72 X 72	77.700
	0 - 50A/100A		
	0 - 60A/120A		
	0 - 75A/150A		
	0 - 100A/200A		
	0 - 150A/300A		
	0 - 200A/400A		
	0 - 250A/500A		
	0 - 300A/600A		
	0 - 400A/800A		
	0 - 500A/1000A		
	0 - 600A/1200A		
	0 - 800A/1600A		
	0 - 1000A/2000A		
	0 - 1200A/2400A		
	0 - 1600A/3200A		
	0 - 2000A/4000A		
	0 - 2500A/5000A		
	0 - 3000A/6000A		
	0 - 4000A/8000A		
0 - 5000A/10000A			
0 - 6000A/12000A			

Amper Meter Direct class: 2.5



Type	Range Ampere	Size	Price (Rp)
FT-96ADT	0 - 10A/20A	96 X 96	84.000
	0 - 15A/30A		
	0 - 25A/50A		
	0 - 30A/60A		
	0 - 40A/80A		
	0 - 60A/120A		
FT-72ADT	0 - 10A/20A	72 X 72	84.000
	0 - 15A/30A		
	0 - 25A/50A		
	0 - 30A/60A		
	0 - 40A/80A		
	0 - 60A/120A		

ANALOG AC PANEL METER



Volt Meter class: 1.5



Type	Range Volatge	Size	Price (Rp)
FT-96V	0 - 500V	96 X 96	81.000
	0 - 300V		
FT-72V	0 - 500V	72 X 72	81.000
	0 - 300V		

Frequency Meter class: 1.0



Type	Range	Model	Size	Price (Rp)
FT-96HZ	45 - 55 HZ/220V	Shock/Getar	96 X 96	239.400
	45 - 55 HZ/220V	Pointer/Jarum		169.000
FT-72HZ	45 - 55 HZ/220V	Shock/Getar	72 X 72	239.400
	45 - 55 HZ/220V	Pointer/Jarum		169.000

Power Factor Meter class: 1.5



Type	Spesifikasi	Size	Price (Rp)
FT-96PF	3phase 400V, via CT/5A, Balanced	96 X 96	302.000

Kilowatt Meter class: 1.5



Type	Spesifikasi	Size	Price (Rp)
FT-96KW	3phase/4 wire, 400V, 3 CT/5A, Unbalance	96 X 96	672.000

Maximum Demand Meter VIA CT /5A class: 1.5

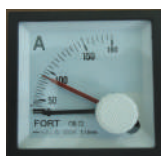

Type	Range Ampere	Size	Price (Rp)
FT-96MD	Via CT...../5A,	96 X 96	302.000

ELECTRONIC ENERGY METER (Kwh METER)



Digital & Analog

SINGLE RATE / TARIF

Description	Type	Rated Current (A)	Price (Rp)
 <p>* 1 Phase , 2W / 50Hz - Class 1 - Direct conection 220VAC - AC voltage 2kV for 1 minute - Impluse voltage 6kV - Pulse output (open Collector) - Dimension 116 X 18 X 62.5 mm - Din - Rail</p>	XTM18S, Analog	5 (30) A	331.800
	XTM18SA, Digital (LCD)	5 (30) A	350.000
 <p>* 1 Phase , 2W / 50Hz - Class 1 - Direct conection 220VAC - AC voltage 2kV for 1 minute - Impluse voltage 6kV - Pulse output (open Collector) - Dimension 88 X 75 X 73 mm - Din - Rail</p>	XTM75S, Analog	5 (30)A	303.000
		10 (60)A	303.000
		20 (100)A	303.000
	XTM75SA, Digital (LCD)	5 (30)A	367.000
		10 (60)A	367.000
		20 (100)A	367.000
 <p>* 3 Phase , 4 W / 50Hz - Class 1 - Rated Volatge 3 X 380/220VAC - Pulse output (open Collector) - Dimension 125 X 88 X 73 mm - Din - Rail</p>	XTM1250S, Analog > Direct	5(30)A	1.102.000
		5(100)A	1.102.000
		10(60)A	1.102.000
		20(100)A	1.102.000
	XTM1250SCT, Analog > By CT	../5A	1.102.000
	XTM1250SA, Digital (LCD) > Direct	5(30)A	1.413.000
		5(100)A	1.413.000
		10(60)A	1.413.000
		20(100)A	1.413.000
	XTM1250SACT, Digital (LCD) > By CT	../5A	1.413.000

ELECTRONIC ENERGY METER (KWH METER)

Digital & Analog



MULTI RATE / DOUBLE TARIF



Description	Type	Rated Current (A)	Price (Rp)
* 1 phase , 2W / 50Hz - Class 1, F1 F2 - Din-Rail, Multi Rate/Doulbe Tarif - Direct conection 220VAC - AC voltage 2kV for 1 minute - Impluse voltage 6kV - Dimension 88 X 75 X 73 mm - Pulse output (open Collector) - Suitable to connect to BAS System, Infra RED - RS485 Port	XTM75SF, Digital (LCD)	5 (30)A	1.081.000
		10 (60)A	1.081.000
		20 (100)A	1.081.000
* 3 phase , 4 W / 50Hz - Class 1, F1 F2 - Din-Rail, Multi Rate/Doulbe Tarif - Rated Volatge 3 X 380/220VAC - Dimension 125 X 88 X 73 mm - Pulse output (open Collector) - Suitable to connect to BAS System, Infra RED - RS485 Port	XTM1250SF, Digital (LCD) > Direct	5(30)A	2.415.000
		10(60)A	2.415.000
		20(100)A	2.415.000
	XTM1250SFCT, Digital (LCD) > By CT	../5A	2.415.000

Informasi :

- * Kwh meter FORT sudah melalui tes uji tipe dan tes uji label dari badan metrologi
- * Harga Kwh meter FORT di price list belum termasuk biaya Tera.
- * Biaya tera Kwh meter single phase Rp. 60.000,- / pcs dan biaya tera Kwh meter 3 phase Rp. 170.000,-/pcs.

CURRENT TRANSFORMER CT



MSQ SERIES



Type	Ratio	Busbar Hole (mm)	Burden (VA)	Class	Price (Rp)
MSQ-30 (Model Kecil)	30/5A	10 X 30	1,5	0,5	50.800
	50/5A		1,5		
	60/5A		1,5		
	75/5A		1,5		
	100/5A		2,5		
	150/5A		2,5		
	200/5A		2,5		
MSQ-30Y (Model Besar)	50/5A	10 X 30	1,5	1,0	67.700
	60/5A		1,5		
	75/5A		1,5		
	100/5A		2,5		
	150/5A		2,5		
	200/5A		2,5		
	250/5A		2,5		
MSQ-40	300/5A	10 X 40	5	0,5	61.300
	400/5A		5		
	500/5A		5		
	600/5A		5		
MSQ-60	500/5A	10 X 60	10	0,5	115.000
	600/5A		10		115.000
	800/5A		10		115.000
	1000/5A		10		121.000
	1200/5A		10		133.000
MSQ-100	800/5A	10 X 100	15	0,5	194.000
	1000/5A		15		194.000
	1200/5A		15		206.000
	1600/5A		15		218.000
	2000/5A		15		238.000
	2500/5A		15		254.000
	3000/5A		15		278.000

MSY SERIES



Type	Ratio	Busbar Hole (mm)	Burden (VA)	Class	Price (Rp)
MSY-30	30/5A	10 X 30	1,5	0,5	71.400
	50/5A		1,5		
	60/5A		1,5		
	100/5A		2,5		
	150/5A		2,5		
	200/5A		5		
	250/5A		5		
MSY-40	300/5A	10 X 40	5	0,5	79.300
	400/5A		5		
	500/5A		5		
MSY-60	600/5A	10 X 40	10	0,5	126.000
	800/5A		10		145.000
	1000/5A		10		161.000
	1200/5A		10		177.000
	1600/5A		15		194.000
MSY-100	800/5A	10 X 100	15	0,5	177.000
	1000/5A		15		194.000
	1200/5A		15		209.000
	1600/5A		15		242.000
	2000/5A		15		266.000
	2500/5A		15		290.000
	3000/5A		15		323.000
	4000/5A		15		461.000
MSY-125/130	4000/5A	60 X 125	15	0,5	461.000
	5000/5A		15		567.000
	6000/5A		15		643.000

CURRENT TRANSFORMER CT



SPLIT CORE CURRENT TRANSFORMER

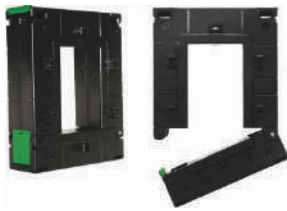

Type	Ratio	Busbar Hole	Burden (VA)	Class	Price (Rp)
MSQ-580FT	400/5A	50 X 80	2,5	1,0	705.000
	500/5A		5,0	1,0	738.000
	600/5A		5,0	1,0	787.000
	800/5A		5,0	1,0	819.000
MSQ-880FT	1000/5A	80 X 80	7,5	1,0	819.000
	1200/5A		7,5	1,0	857.000
MSQ-812FT	1200/5A	80 X 120	10	1,0	908.000
	1500/5A		10	1,0	983.000
	1600/5A		10	1,0	1.008.000
	2000/5A		10	1,0	1.229.000
MSQ-816FT	2500/5A	80 X 160	20	1,0	2.294.000
	3000/5A		25	1,0	2.376.000
	4000/5A		25	1,0	2.457.000
	5000/5A		25	1,0	2.646.000
	6300/5A		25	1,0	2.898.000



RCT CURRENT TRANSFORMER



Type	Ratio	Diameter (mm)	Burden (VA)	Class	Price (Rp)
RCT-35	50/5A	35	1,5	0,5	127.000
	60/5A		1,5		
	100/5A		1,5		
	150/5A		2,5		
	200/5A		3,75		
	250/5A		3,75		
RCT-60	300/5A	60	2,5	0,5	158.000
	400/5A		5		
	500/5A		5		
	600/5A		5		
RCT-90	800/5A	90	5	0,5	212.000
	1000/5A		15		245.000
	1200/5A		15		278.000
RCT-110	1600/5A	110	20	0,5	357.000
	2000/5A		20		423.000
	2500/5A		20		502.000
	3000/5A		20		608.000

CURRENT TRANSFORMER CT



CT PROTECTION



Type	Ratio	Inner Diameter (mm)	Outer Diameter (mm)	High (mm)	Price (Rp)
PR34 5P10	100/5	34	100	180	1.393.000
PR34 5P10	150/5	34	100	130	972.000
PR34 5P10	200/5	34	100	110	856.000
PR45 5P10	250/5	45	96	110	723.000
PR45 5P10	300/5	45	96	110	692.000
PR45 5P10	400/5	45	96	90	538.000
PR60 5P10	500/5	60	100	100	587.000
PR68 5P10	600/5	68	110	78	723.000
PR85 5P10	800/5	85	120	78	692.000
PR82 5P10	1000/5	82	123	70	769.000
PR82 5P10	1200/5	82	123	70	712.000
PR82 5P10	1600/5	82	123	60	821.000
PR125 5P10	2000/5	125	178	38	931.000
PR125 5P10	2500/5	125	178	35	1.041.000
PR120 5P10	3000/5	120	178	35	973.000
PR140 5P10	3500/5	140	200	35	1.151.000
PR140 5P10	4000/5	140	200	35	1.430.000
PR140 5P10	5000/5	140	200	35	1.718.000
PR140 5P10	6300/5	140	200	35	1.850.000



SHUNT FOR DC AMPERE METER



Type	DC Ampere	Voltage (VA)	Class	Price (Rp)
SHT-5A	5A	75mV	0,5	226.000
SHT-10A	10A			183.000
SHT-15A	15A			193.000
SHT-20A	20A			200.000
SHT-40A	40A			207.000
SHT-50A	50A			214.000
SHT-75A	75A			406.000
SHT-100A	100A			440.000
SHT-150A	150A			454.000
SHT-200A	200A			482.000
SHT-250A	250A			509.000
SHT-300A	300A			578.000

INDICATOR LAMP LED



PILOT LAMP "LED" 30MM



Description	Diameter (mm)	Voltage (V)	Color	Type	Price (Rp)
Direct, with LED indicator	30	220VAC	Red	AD22-30DS	18.400
		24VDC	Green		
			Yellow		

PILOT LAMP "LED" 22MM



Description	Diameter (mm)	Voltage (V)	Color	Type	Price (Rp)	
Direct, with LED indicator	22	380VAC	Green	AD22-22DS	8.500	
		220VAC	Red			
		110VAC	Yellow			
		24VDC	Blue	AD22-22DS		10.500
		12VDC	White			

PILOT LAMP "LED" 22MM



Description	Diameter (mm)	Voltage (V)	Color	Type	Price (Rp)
Direct, with LED indicator	22	220VAC	Green	AD22-22DSC	7.500
			Red		
			Yellow		
		24VDC	Blue		
			White		

PILOT LAMP "LED" 22MM



Description	Diameter (mm)	Voltage (V)	Color	Type	Price (Rp)
Direct, with LED indicator	22	220VAC	Red	AD22-22DS	7.900
			Green		
			Yellow		

INDICATOR LAMP LED



WATER PROOF "LED" LAMP 22MM " IP65"



Description	Diameter (mm)	Voltage (V)	Color	Type	Price (Rp)
Direct, with LED indicator	22	220VAC	Green Red Yellow	AD22-22DS/WP	13.300
			Blue White		14.200

PILOT LAMP LED (LAMPU LED BISA DIBUKA)



Description	Diameter (mm)	Voltage (V)	Color	Type	Price (Rp)
Direct, with LED indicator	22	220VAC	Green	XB7-EV63	22.000
		24VDC	Red	XB7-EV64	
		12VDC	Yellow	XB7-EV65	

PILOT LAMP (LED) 16MM SCREW MOUNTING



Description	Diameter (mm)	Voltage (V)	Color	Type	Price (Rp)
Direct, with LED indicator	16	220VAC	Green	AD22-16DS	9.600
		24VDC	Red		
		12VDC	Yellow		

INDICATOR LAMP LED



SWITCH POSITION INDICATOR LED LAMP



Description	Diameter (mm)	Voltage (V)	Type	Price (Rp)
Circuit Breaker Position Indicator	22	220VAC	AD116-22W/D	38.800
Grounding Position Indicator			AD116-22W/N	38.800
Isolating Switch Position Indicator			AD116-22W/G	38.800

PILOT LAMP WITH METERING



Description	Diameter (mm)	Voltage (V)	Color	Model	Type	Price (Rp)
Pilot Lamp with V + A meter * Voltage 24 - 550VAC * Ampere 1 - 100A	22	220VAC	Red Yellow Green	Bulat	AD116-22DSAVB	66.200
				Kotak	AD116-22DSAVK	
Pilot Lamp with V + A + Hz meter * Voltage 24 - 550VAC * Ampere 1 - 100A * Hz range 0 - 999Hz	22	220VAC	Red Yellow Green	Kotak	AD116-22DSAVH	75.000
Pilot Lamp with Voltmeter * Voltage 24 - 550VAC	22	220VAC	Red Yellow Green	Bulat	AD116-22DSVVB	26.300
				Kotak	AD116-22DSVK	
Pilot Lamp with Ampere Meter * Ampere 1 - 100A * Include CT max. 100A	22	220VAC	Red Yellow Green	Bulat	AD116-22DSAB	57.700
				Kotak	AD116-22DSAK	
Pilot Lamp with Frequency Meter * Hz range 0 - 999Hz	22	220VAC	Red Yellow Green	Bulat	AD116-22DSHZB	26.300
				Kotak	AD116-22DSHZK	
Pilot Lamp with Thermo Meter * Display offset : -25°C to +150 °C	22	220VAC	Red	Bulat	ED16-22FTB	57.000
				Kotak	ED16-22FTK	

METAL PUSH BUTTON WITH LED LAMP



Description	Diameter (mm)	Contact	Color	Type	Price (Rp)
Flash Head *With LED lamp, 3A/250VAC * IP65 *Material Metal	16	1NO+1NC	Blue	MP016S/F11Z	65.000
	22	1NO+1NC	Blue	MP022S/F11Z	120.000

COMMAND SWITCH LAY-5 SERIES



PILOT LAMP "NEON"



Description	Diameter (mm)	Voltage (V)	Color	Type	Price (Rp)
Direct, with bulb indicator	22	220VAC	Green	LAY5-BV63	27.500
			Red	LAY5-BV64	
			Yellow	LAY5-BV65	
With Transformer 220V / 6V	22	220VAC	Green	LAY5-BV43	55.000
			Red	LAY5-BV44	
			Yellow	LAY5-BV45	

PUSH BUTTON



Description	Diameter (mm)	Contact	Color	Type	Price (Rp)
Flush Head, spring return	22	1NO/1NC	Red	LAY5-BA42	17.900
			Green	LAY5-BA31	
			Yellow	LAY5-BA51	
			Blue	LAY5-BA61	
			Black	LAY5-BA21	

ILUMINATED PUSH BUTTON WITH NEON



Description	Diameter (mm)	Contact	Color	Type	Price (Rp)
Flush Head - Direct, 220 VAC	22	1NO/1NC	Green	LAY5-BW3361	29.900
			Red	LAY5-BW3461	
			Yellow	LAY5-BW3561	
- With Transformer, 220V/6V	22	1NO/1NC	Green	LAY5-BW3341	60.000
			Red	LAY5-BW3441	
			Yellow	LAY5-BW3541	

PUSH BUTTON



Description	Diameter (mm)	Contact	Color	Type	Price (Rp)
Flush head, spring return * START / STOP	22	1NO	Red	LAY5-EA142	8.000
		1NC	Green	LAY5-EA131	
Flush Head, spring return	22	1NO/1NC	Red	XB7-EA42	9.000
			Green	XB7-EA31	
			Yellow	XB7-EA51	

COMMAND SWITCH LAY-5 SERIES



SELECTOR SWITCHES



Description	Diameter (mm)	Contact	Color	Type	Price (Rp)
2 Position stay put	22	1 NO	Black	LAY5-BD21	22.600
3 Position stay put		2 NO	Black	LAY5-BD33	25.700
2 Position Spring Return (Diputar balik lagi)	22	1 NO	Black	LAY5-BD45	26.000
3 Position Spring Return (Diputar balik lagi)		2 NO	Black	LAY5-BD53	30.000
2 Position stay put (long handle)	22	1 NO	Black	LAY5-BJ21	26.300
3 Position stay put (long handle)		2 NO	Black	LAY5-BJ33	31.000
Key Switch 2 or 3 Position stay put	22	1 NO	Black	LAY5-BG21	39.200
		2 NO	Black	LAY5-BG33	41.600

ILUMINATED SELECTOR SWITCHES (SELECTOR SWITCH DENGAN LAMPU)



Description	Diameter (mm)	Contact	Color	Type	Price (Rp)
2 Position stay put	22	1 NO 1NC	Red	LAY5-BK2	60.500
3 Position stay put		2NO	Yellow Green	LAY5-BK3	

EMERGENCY PUSH BUTTON



Description	Diameter (mm)	Contact	Color	Type	Price (Rp)
Mushroom Head Φ 40mm Spring Return	22	1 NC	Red	LAY5-BC42	22.500
Mushroom Head Φ 40mm Push lock - Turn to release	22	1 NC	Red	LAY5-BS542	23.800
Mushroom Head Φ 40mm Push lock - Turn to release, with key	22	1 NC	Red	LAY5-BS142	55.000

COMMAND SWITCH LAY-4 SERIES



PILOT LAMP " LED "



Description	Diameter (mm)	Voltage (V)	Color	Type	Price (Rp)
Direct, with LED indicator	22	220 VAC	Green	LAY4-BV63	43.000
			Red	LAY4-BV64	
			Yellow	LAY4-BV65	

PUSH BUTTON

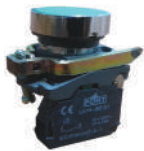

Description	Diameter (mm)	Contact	Color	Type	Price (Rp)
Flush Head, spring return	22	1NO/1NC	Red	LAY4-BA42	27.200
			Green	LAY4-BA31	
			Yellow	LAY4-BA51	

ILLUMINATED PUSH BUTTON WITH LED



Description	Diameter (mm)	Contact	Color	Type	Price (Rp)
Flush Head - Direct, 220 VAC	22	1NO/1NC	Green	LAY4-BW3361	53.500
			Red	LAY4-BW3461	
			Yellow	LAY4-BW3561	

SELECTOR SWITCHES



Description	Diameter (mm)	Contact	Color	Type	Price (Rp)
2 Position stay put	22	1 NO	Black	LAY4-BD21	30.900
3 Position stay put		2 NO	Black	LAY4-BD33	38.000
Key Switch	22	1NO	Black	LAY4-BG21	55.800
2 or 3 Position stay put		2 NO	Black	LAY4-BG33	58.200

EMERGENCY PUSH BUTTON



Description	Diameter (mm)	Contact	Color	Type	Price (Rp)
Mushroom Head Ø 40mm Spring Return	22	1 NC	Red	LAY4-BC42	33.300
Mushroom Head Ø 40mm Push lock - Turn to release	22	1 NC	Red	LAY4-BS542	42.800

COMMAND SWITCH LA115 - SERIES



PUSH BUTTON



Description	Diameter (mm)	Contact	Color	Type	Price (Rp)
Flush Head, spring return	22	1NO/1NC	Red	LA115-A5-01	20.500
			Green	LA115-A5-10	
			Yellow	LA115-A5-10	
			Blue	LA115-A5-10	
			Black	LA115-A5-10	
Push Lock - Push Release (Ditekan Kunci - Ditekan lagi lepas/ balik)	22	1NO/1NC	Red	LA115-A5-01T	24.700
			Green	LA115-A5-10T	
			Yellow	LA115-A5-10T	

ILUMINATED PUSH BUTTON WITH LED, 220VAC



Description	Diameter (mm)	Contact	Color	Type	Price (Rp)
Flush Head, spring return	22	1NO/1NC	Red	LA115-A5-01D	48.900
			Green	LA115-A5-10D	
			Yellow	LA115-A5-10D	
Push Lock - Push Release (Ditekan Kunci - Ditekan lagi lepas/ balik)	22	1NO/1NC	Red	LA115-A5-01HFTD	50.900
			Green	LA115-A5-10HFTD	
			Yellow	LA115-A5-10HFTD	

SELECTOR SWITCHES



Description	Diameter (mm)	Contact	Color	Type	Price (Rp)
2 Position stay put	22	1 NO	Black	LA115-A5-10X	21.500
3 Position stay put		2 NO	Black	LA115-A5-20XS	29.800
2 Position stay put (long handle)	22	1 NO	Black	LA115-A5-10CX	25.100
3 Position stay put (long handle)		2 NO	Black	LA115-A5-20CXS	31.400
2 Position Spring Return (Diputar balik lagi)	22	1NO	Black	LA115-A5-10X/FU	28.000
3 Position Spring Return (Diputar balik lagi)		2 NO	Black	LA115-A5-20XS/FFU	36.900

COMMAND SWITCH LA115 - SERIES



ILUMINATED SELECTOR SWITCHES (SELECTOR SWITCH W/LAMPU LED), 220VAC



Description	Diameter (mm)	Contact	Color	Type	Price (Rp)
2 Position stay put	22	1 NO	Red	LA115-A5-10XD	37.400
3 Position stay put		2NO	Yellow Green	LA115-A5-20XSD	44.000

EMERGENCY PUSH BUTTON



Description	Diameter (mm)	Contact	Color	Type	Price (Rp)
Spring Return	22	1 NC	Red Green	LA115-A5-01M	23.800
Push lock - Turn to release, tanpa lampu	22	1 NC	Red	LA115-A5-01ZF	61.800
Push lock - Turn to release, with LED 220VAC	22	1 NC	Red	LA115-A5-01ZFD	77.200

DOUBLE PUSH BUTTON



Description	Diameter (mm)	Color	Type	Price (Rp)
Double push button name plate 1 - 0 with LED, 220VAC	22	Red	LA115-A5-11RD/1	49.900
		Green		

COMMAND SWITCH HB - SERIES



PUSH BUTTON



Description	Diameter (mm)	Contact	Color	Type	Price (Rp)
Flush Head, spring return	25	1NO 1NC	Red Green Yellow	HB-2511	26.800
	30	1NO 1NC	Red Green Yellow	HB3011	32.600

ILLUMINATED PUSH BUTTON WITH TRANSFORMER



Description	Diameter (mm)	Contact	Color	Type	Price (Rp)
Flush Head, spring return, 220 VAC, with transformer	25	1NO 1NC	Red Green Yellow	HB-2511D	90.700
	30	1NO 1NC	Red Green Yellow	HB-3011D	97.900

EMERGENCY PUSH BUTTON



Description	Diameter (mm)	Contact	Color	Type	Price (Rp)
Mushroom Head, Φ 40mm Push lock - Turn to release	25	1NO 1NC	Red Green	HB-2511TS	38.400
	30	1NO 1NC	Red Green	HB-3011TS	42.000
Mushroom Head, Φ 40mm Spring Return	25	1NO 1NC	Red Green	HB-2511M	38.200
	30	1NO 1NC	Red Green	HB-3011M	39.900

SELECTOR SWITCHES



Description	Diameter (mm)	Contact	Color	Type	Price (Rp)
2&3 Position stay put	25	1NO 1NC	Black	HB2511X/2	30.900
				HB2511X/3	
2&3 Position stay put	30	1NO 1NC	Black	HB3011X/2	45.900
				HB3011X/3	

Price List 2024

COMMAND SWITCH MODEL IDEC/IZUMI



PILOT LAMP



Description	Diameter (mm)	Voltage (V)	Color	Type	Price (Rp)
Direct, with bulb indicator	22 / 25	220	Green Red Yellow	APW 199E	20.000

PUSH BUTTON



Description	Diameter (mm)	Voltage (V)	Color	Type	Price (Rp)
Flush Head, spring return	22 / 25	1NO 1NC	Red Green Yellow	ABW111EP	25.200

ILUMINATED PUSH BUTTON



Description	Diameter (mm)	Voltage (V)	Color	Type	Price (Rp)
Extended Head - Direct, 220 VAC	22 / 25	1NO 1NC	Green Red Yellow	ALW29911EP	38.900

EMERGENCY PUSH BUTTON



Description	Diameter (mm)	Voltage (V)	Color	Type	Price (Rp)
Mushroom Head, Φ 40mm Push lock - Turn to release	22 / 25	1NO 1NC	Red	AVW411ERP	36.300

SELECTOR SWITCHES



Description	Diameter (mm)	Voltage (V)	Color	Type	Price (Rp)
2 Position stay put	22 / 25	1NO 1NC	Black	XPB22-22A-11X/21	34.600
3 Position stay put				XPB22-22A-11X/31	
Key Switch 2 or 3 Position stay put	22 / 25	1NO 1NC	Black	XPB22-22A-11Y/21 XPB22-22A-11Y/31	59.300

COMMAND SWITCH 25MM/30MM



PUSH BUTTON



Description	Diameter (mm)	Contact	Color	Type	Price (Rp)
Flush Head, spring return	25	1NO 1NC	Red Green Yellow	PB2511	14.500
	30	1NO 1NC	Red Green Yellow	PB3011	16.500

EMERGENCY PUSH BUTTON



Description	Diameter (mm)	Contact	Color	Type	Price (Rp)
Mushroom Head, Φ 40mm Push lock - Turn to release	25	1NO 1NC	Red	RE2511	23.100
	30	1NO 1NC	Red	RE3011	25.000

SELECTOR SWITCHES



Description	Diameter (mm)	Contact	Color	Type	Price (Rp)
2 & 3 Position stay put	25	1NO 1NC	Black	SS2511/2	17.000
				SS2511/3	
2 & 3 Position stay put	30	1NO 1NC	Black	SS3011/2	20.000
				SS3011/3	

COMMAND SWITCH



DOUBLE PUSH BUTTON



Description	Diameter (mm)	Color	Type	Price (Rp)
Double Push Button with lamp 220Vac	22/25	Red+Green	SCB-220	30.000
	30	Red+Green	SCB-230	30.000
	30	Red+Green	PB30N	32.000
	22	Red+Green	LA115-A5-11RD/1	49.900
	22	Red+Green	LAY5-BW8565	52.500

CONTACT BLOCK COMMAND SWITCH



Description	Type	Price (Rp)
> Contact Block for LAY5 Contact Block, 1 NO Contact Block, 1 NC	LAY5-BE101	7.900
	LAY5-BE102	7.900
> Contact Block for LAY4 Contact Block, 1 NO Contact Block, 1 NC	LAY4-BE101	10.000
	LAY4-BE102	10.000
> Contact Block for push button model Idec	NO	10.000
	NC	10.000
> Contact Block for LA115-A5 Contact Block, 1 NO Contact Block, 1 NC	LA115-10	11.000
	LA115-01	11.000

COMMAND SWITCH 16MM



PILOT LAMP WITH LED



SDL16-AXD



SDL16-CFXD

Description	Diameter (mm)	Voltage (V)	Color	Type	Price (Rp)
Direct, with LED indicator	16	220VAC 24VDC	Green	SDL16-AXD	22.000
- Circular (bulat)			Red	SDL16-CFXD	
- Rectangular (panjang)			Yellow		

PUSH BUTTON



SDL16-22A



SDL16-22CF

Description	Diameter (mm)	Contact	Color	Type	Price (Rp)
Flush Head	16	2NO 2NC	Green	SDL16-22A	26.300
- Circular (bulat)			Red	SDL16-22AL	
- Rectangular (panjang)			Yellow	SDL16-22CF	
				SDL16-22CFL	

ILUMINATED PUSH BUTTON WITH LED



SDL16-22AD



SDL16-22CFD

Description	Diameter (mm)	Contact	Color	Type	Price (Rp)
Flush Head	16	2NO 2NC	Green	SDL16-22AD	35.700
- Direct, 220 Vac				SDL16-22ADL	
- Direct, 24 Vac/dc			Red	SDL16-22CFD	
- Circular (bulat)				SDL16-22CFDL	
- Square (persegi)				SDL16-22FD	
- Rectangular (panjang)				SDL16-22FDL	

EMERGENCY PUSH BUTTON



SDL16-22ZS

Description	Diameter (mm)	Contact	Color	Type	Price (Rp)
Mushroom Head	16	2NO 2NC	Red	SDL16-22ZS	44.100

SELECTOR SWITCHES



SDL16-22XF



SDL16-22XA

Description	Diameter (mm)	Contact	Color	Type	Price (Rp)
*2 posisi Circular	16	1 NO 1NC	Black	SDL16-11XF	43.000
*2 posisi Square				SDL16-11XA	
*3 posisi Circular	16	2NO 2NC	Black	SDL16-22XF	44.000
*3 posisi Square				SDL16-22XA	

COMMAND SWITCH ACCESSORIES



ACCESSORIES FOR PILOT LAMP & PUSH BUTTON



Description	Voltage	Color	Type	Price (Rp)
Lampu Neon untuk pilot lamp/Push button lamp, 22/25/30MM	220VAC, 24VDC	Red, Green, Yellow	NEON-22	7.900
Lampu LED untuk pilot lamp/Push button lamp, 22/25/30mm	220VAC, 24VDC	Red, Green, Yellow	BS06	9.400
Lampu LED untuk pilot lamp/Push button lamp, 16mm	220VAC, 24VDC	Red, Green, Yellow	BS02	9.400
Legend Plate For 22mm, 25mm, 30mm			LAY5-22	1.200
Protection Cover For Emergency Push Button 22mm (Size 55 x 2.5mm)			LAY5-22/PC	18.000
Protection Cover For 16mm > Rectangular (persegi panjang) > Cicular (bulat) & Square (persegi)			LAY5-16/PCR	8.000
			LAY5-16/PCS	
Hole Extention / penutup lobang, size 22mm			FPP-22	1.800

ACCESSORIES FOR PUSH BUTTON



Description	Type	Size Hole (mm)	Dimension (mm)	Price (Rp)
Name plate	GXB2-ER60	22/25	60	3.200
	GXB2-ER90	22/25	90	8.900
Protection Emergency	GXB2-EB70F	22/25	70	29.900
	GXB2-EB90F	22/25	90	
	GXB2-EB65/80F	22/25	80	45.000
	GXB2-EB48/56F	22/25	56	16.500

CONTROL SWITCH BOX



BOX PUSH BUTTON STATION 22MM



Description	Type	Color	Price (Rp)
1 Hole / Lubang	BX1 - 22	White / Yellow	17.000
2 Hole / Lubang	BX2 - 22	White / Yellow	20.500
3 Hole / Lubang	BX3 - 22	White / Yellow	29.400
4 Hole / Lubang	BX4 - 22	White / Yellow	33.000
5 Hole / Lubang	BX5 - 22	White / Yellow	52.800

BOX PUSH BUTTON STATION 22MM



Description	Type	Color	Price (Rp)
1 Hole / Lubang	GOB - 1A	Grey / Yellow	36.300
2 Hole / Lubang	GOB - 2A	Grey / Yellow	47.100
3 Hole / Lubang	GOB - 3A	Grey / Yellow	62.800

POWER PUSH BUTTON



Type	Description	Model	Ampere (A)	Price (Rp)
BS216B	Economic Quality	ON-OFF	15A/2.2kW	24.200
BS230B		ON-OFF	30A/3.7kW	28.400
TBSN-315	Premium Quality	ON-OFF	15A/2.2kW	44.100
TBSN-330		ON-OFF	30A/3.7kW	59.900
TBSS-315, Inbow		ON-OFF	15A/2.2kW	53.600
TBSS-330, Inbow		ON-OFF	30A/3.7kW	60.900

CONTROL PUSH BUTTON



Model	Description	Type	Ampere (A)	Price (Rp)
ON - OFF	Economic Quality	BT-2	3A / 250V	18.400
FWD - REV - OFF		BT-3		26.300
ON - OFF	Premium Quality	TPB-2		34.700
FWD - REV - OFF		TPB-3		43.100

CONTROL SWITCH



HOIST PUSH BUTTON



Description	Type	Model	Ampere (A)	Price (Rp)
Hoist Push Button without Emergency Stop	COB-61	2 button	5	32.000
	COB-62	4 button		45.000
	COB-63	6 button		67.000
Hoist Push Button with Emergency Stop	COB-61P	2 button	5	100.000
	COB-62P	4 button		128.700
	COB-63P	6 button		175.000
Double Speed Hoist Push Button with Emergency Stop	XAC-A2913	2 button	5	300.000
	XAC-A4913	4 button		411.000
	XAC-A6913	6 button		564.000

WIRELESS HOIST PUSH BUTTON



Description	Type	Channel	Max. Distance	Price (Rp)
* Voltage 380VAC / 50Hz * Maximum Distance 100M	F21-E1B-4S	4	100 M	1.365.000
	F21-E1B-6S	6	100 M	1.439.000
	F21-E1B-8S	8	100 M	1.481.000

MODULAR CONTACTORS



Description	Rate Current Ith (A)	Pole	Contact	Type	Price (Rp)
AC contactor * Coil Voltage : 220VAC / 50Hz	25A	2	1NO 1NC	HC-225-230-11	204.000
		2	2NO	HC-225-230-20	
		2	2NC	HC-225-230-02	
	40A	2	1NO 1NC	HC-240-230-11	396.000
		2	2NO	HC-240-230-20	
		2	2NC	HC-240-230-02	

ROTARY SWITCH



ROTARY SWITCH SA16 / SFT-20 SERIES

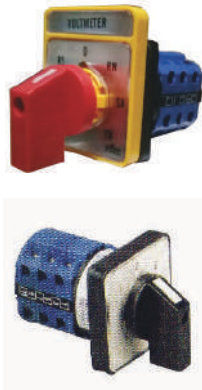

Description	Type	Name Plate	Price (Rp)
Volt Selector	SFT20-7	RN-SN-TN-0-RS-ST-TR	84.000
Ampere Selector	SFT20-4	0-R-S-T	84.000
Change Over Switch	SFT20-3-1	A-O-M, 1P	53.600
	SFT20-3-2	A-O-M, 2P	70.900
	SFT20-3-3	A-O-M, 3P	84.000
	SFT20-3-1	1-0-2, 1P	53.600
	SFT20-3-2	1-0-2, 2P	70.900
	SFT20-3-3	1-0-2, 3P	84.000
	SFT20-4-1	0-1-2-3, 1P	80.900
	SFT20-4-2	0-1-2-3, 2P	113.400
	SFT20-4-3	0-1-2-3, 3P	139.700
	SFT20-2-1	ON-OFF, 1P	53.600
SFT20-2-2	ON-OFF, 2P	72.500	
SFT20-2-3	ON-OFF, 3P	84.000	

ROTARY SWITCH SF22 SERIES



Description	Type	Name Plate	Price (Rp)
Volt Selector	SF22-7	RN-SN-TN-0-RS-ST-TR	116.600
Ampere Selector	SF22-4	0-R-S-T	116.600
Change Over Switch	SF22-3-1	A-O-M, 1P	81.900
	SF22-3-2	A-O-M, 2P	105.000
	SF22-3-3	A-O-M, 3P	116.600
	SF22-3-1	1-0-2, 1P	81.900
	SF22-3-2	1-0-2, 2P	105.000
	SF22-3-3	1-0-2, 3P	116.600

CAM SWITCH



Description	Type	Ampere (A)	Name Plate	Price (Rp)
Change over swithc 3P * size 64 X 64	SA-25-3, 25A	25	ON - OFF	158.000
	SA-25-3-3, 25A	25	ON - OFF - ON	168.000
	SA-32-3, 32A	32	ON - OFF	210.000
	SA-32-3-3, 32A	32	ON - OFF - ON	231.000
	GS04-25/3P	25	ON - OFF	166.000
	GS04-32/3P	32	ON - OFF	179.000
	GS04-63/3P	63	ON - OFF	255.000
	GS04-100/3P	100	ON - OFF	499.000

CAM SWITCH WITH BOX



Description	Type	Ampere (A)	Name Plate	Price (Rp)
* 3Phase / 380VAC	SA-25-3 D, 25A	25	ON - OFF	249.000
	SA-32-3 D, 32A	32	ON - OFF	326.000

CAM STATER



GZ & GA SERIES (METAL BODY)



Type	Pole	Ampere (A)	Name Plate	Price (Rp)
GA-16	3	16	ON - OFF	261.000
GZ-16	3	16	ON - OFF - ON	273.000
GA-25	3	25	ON - OFF	297.000
GZ-25	3	25	ON - OFF - ON	311.000
GA-32	3	32	ON - OFF	310.000
GZ-32	4	32	ON - OFF - ON	325.000
GA-40	3	40	ON - OFF	510.000
GZ-40	4	40	ON - OFF - ON	530.000
GA-63	3	63	ON - OFF	888.000
GZ-63	4	63	ON - OFF - ON	935.000
GZ-100	4	100	ON - OFF - ON	1.540.000



QS5 SERIES (CAST RESIN BODY)



Type	Pole	Ampere (A)	Name Plate	Price (Rp)
QS5-15A	3	15	ON - OFF - ON	59.000
QS5-30A	3	30	ON - OFF - ON	88.000
QS5-60A	4	60	ON - OFF - ON	185.000
QS5-100A	4	100	ON - OFF - ON	930.000



WEATHER PROTECTION ISOLATION SWITCH



Description	Pole	Current (A)	Type	Price (Rp)
* ON - OFF swith * Volatge : 240V/415VAC * IP 66	2 (1phase)	25	UKF125	129.900
	2 (1phase)	40	UKF140	133.200
	2 (1phase)	63	UKF163	141.200
	3 (3phase)	25	UKF325	163.700
	3 (3phase)	40	UKF340	169.400
	3 (3phase)	63	UKF363	175.200

LOAD BREAK SWITCH (LBS) DIN-RAIL WITH HANDLE OPERATION

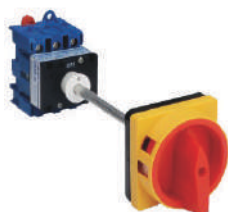

Type	Pole	Ampere (A)	Name Plate	Price (Rp)
LGZ-25-3	3	25	ON - OFF	302.000
LGZ-32-3	3	32	ON - OFF	350.000
LGZ-63-3	3	63	ON - OFF	429.000

LOAD BREAK SWITCH (LBS)

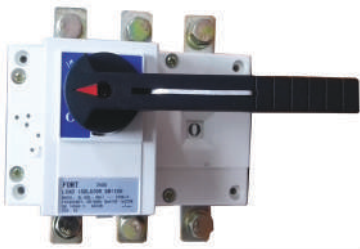

Type	Pole	Ampere (A)	Name Plate	Price (Rp)
GGL-160/3	3	160	I - O	408.000
GGL-250/3	3	250	I - O	555.000
GGL-400/3	3	400	I - O	1.188.000
GGL-630/3	3	630	I - O	1.564.000
GGL-1000/3	3	1000	I - O	3.554.000
GGL-1250/3	3	1250	I - O	4.652.000
GGL-1600/3	3	1600	I - O	5.686.000
GGL-2000/3	3	2000	I - O	14.214.000

LOAD BREAK SWITCH WITH NH FUSE

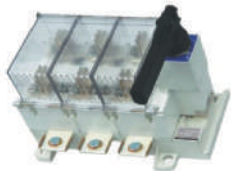

Type	Pole	Ampere (A)	Size Fuse	Name Plate	Price (Rp)
HGLR-160/3	3	160	NH-00	I - O	870.000
HGLR-250/3	3	250	NH-1	I - O	1.824.000
HGLR-400/3	3	400	NH-2	I - O	2.609.000
HGLR-630/3	3	630	NH-3	I - O	5.796.000

EXTENTION SHAFT / HANDLE OUTDOOR FOR LBS



Type	For LBS	Price (Rp)
HDGGL-250	160A - 250A	430.000
HDGGL-630	400A - 630A	460.000
HDGGL-1250	800A - 1250A	510.000
HDGGL-2000	1600A - 2000A	552.000

CHANGE OVER SWICTH

DIN - RAIL COS (MCB SERIES)



Type	Pole	Rate Current (A)	Function	Price (Rp)
SF 219G - 25	2	25	I - O - I	120.000
SF 219G - 32	2	32	I - O - I	
SF 219G - 40	2	40	I - O - I	
SF 219G - 63	2	63	I - O - I	
SF 419G - 25	4	25	I - O - I	220.000
SF 419G - 32	4	32	I - O - I	
SF 419G - 40	4	40	I - O - I	
SF 419G - 63	4	63	I - O - I	

COS (SIRCO SERIES)



Type	Pole	Ampere (A)	Function	Price (Rp)
FCOS-40/3	3	40	I - O - II	656.200
FCOS-40/4	4		I - O - II	721.900
FCOS-63/3	3	63	I - O - II	799.800
FCOS-63/4	4		I - O - II	823.200

Price List 2024

CHANGE OVER SWITCH (COS)



Type	Pole	Ampere (A)	Name Plate	Price (Rp)
GGLZ-63/4	4	63	I - O - I	975.000
GGLZ-100/4	4	100	I - O - I	990.000
GGLZ-160/4	4	160	I - O - I	1.200.000
GGLZ-250/4	4	250	I - O - I	1.657.000
GGLZ-400/4	4	400	I - O - I	3.387.000
GGLZ-630/4	4	630	I - O - I	4.664.000
GGLZ-1000/4	4	1000	I - O - I	10.779.000
GGLZ-1250/4	4	1250	I - O - I	14.720.000
GGLZ-1600/4	4	1600	I - O - I	15.991.000
GGLZ-2000/4	4	2000	I - O - I	46.196.000

AUTOMATIC TRANSFER SWITCH (ATS)



Type	Pole	Ampere (A)	Name Plate	Price (Rp)
GGLD-63/4	4	63	I - O - I	2.415.000
GGLD-100/4	4	100	I - O - I	2.536.000
GGLD-125/4	4	125	I - O - I	3.209.000
GGLD-160/4	4	160	I - O - I	3.378.000
GGLD-250/4	4	250	I - O - I	3.889.000
GGLD-400/4	4	400	I - O - I	7.094.000
GGLD-630/4	4	630	I - O - I	7.938.000
GGLD-1000/4	4	1000	I - O - I	20.267.000
GGLD-1250/4	4	1250	I - O - I	25.116.000
GGLD-1600/4	4	1600	I - O - I	26.324.000
GGLD-2000/4	4	2000	I - O - I	69.552.000
FDQ2-63/2	2	63	ON - OFF - ON	483.000
FDQ2-63/4	4	63	ON - OFF - ON	518.000
FDQ3-100/4	4	100	ON - OFF - ON	2.234.000
FDQ3-225/4	4	225	ON - OFF - ON	2.898.000
FDQ3-400/4	4	400	ON - OFF - ON	8.815.000

EXTENTION SHAFT / HANDLE OUTDOOR FOR COS



Type	For COS & ATS	Price (Rp)
HDGGLZ-250	160A - 250A	430.000
HDGGLZ-630	400A - 630A	460.000
HDGGLZ-1250	800A - 1250A	510.000
HDGGLZ-2000	1600A - 2000A	552.000

DISCONNECTING SWITCH



Description	Type	Name Plate	Price (Rp)
2P/63A, 4,5kA, for FDQ2/2P	DZ47-63A/2P	ON - OFF	42.000
4P/63A, 4,5kA, for FDQ2/4P	DZ47-63A/4P	ON - OFF	84.000

LOW VOLTAGE FUSE



NH FUSE LINK



Type	Ampere (A)	Price (Rp)
NH-00	25, 35, 40, 50, 63, 80, 100, 125, 160	27.700
NH-0	50, 63, 80, 100, 125, 160	48.300
NH-1	63, 80, 100, 125, 160, 200, 250	57.800
NH-2	250, 300, 315, 355, 400	84.000
NH-3	300, 500, 630	112.400
NH-4	1000, 1250	514.500

NH FUSE HOLDER

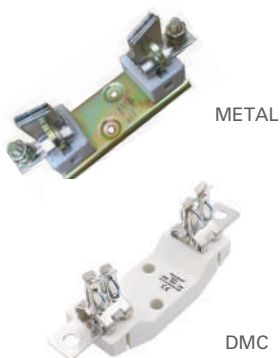

For Fuse	Type	Material	Rate Current	Price (Rp)
NH-00	FFH-NH00	METAL	160 A	35.700
	FRH-NH00	RESIN/DMC		41.000
NH-0	FFH-NH0	METAL	160 A	60.900
NH-1	FFH-NH1	METAL	250 A	98.700
	FRH-NH1	RESIN/DMC		115.000
NH-2	FFH-NH2	METAL	400 A	150.000
	FRH-NH2	RESIN/DMC		160.000
NH-3	FFH-NH3	METAL	630 A	220.000
NH-4	FFH-NH4	METAL	1250 A	630.000

NH FUSE PULLER / CARRIER FUSE



Type	Ampere (A)	Price (Rp)
FFP-1250	1250A	42.000



FUSE



Description	Type	Pole	Price (Rp)
Fuse kubur with fuse glass 10Ampere	FS-101	1	5.800
	FS-103	3	17.300
Panel Mounting Fuse Holder without fuse glass	BLX-5X20	1	2.700
	BLX-6X30	1	3.500
Din Rail Mounting Fuse Holder with lamp Model MCB	RT18-32(X)	1	14.900
Fuse Link 10 X 38 2A, 4A, 6A, 10A, 16A, 20A, 25A, 32 A	FFL-1038	1	3.500



MEDIUM VOLTAGE FUSE LINK

24KV / 40KA



UKURAN DIAMETER KEPALA KECIL (45MM)



Ampere In (A)	Type	Dimension (mm)			Price (Rp)
		A	D	L	
12	FMVF-12	45	51	442	700.000
16	FMVF-16		51		700.000
20	FMVF-20		51		700.000
25	FMVF-25		51		700.000
31,5	FMVF-31.5		51		700.000
32	FMVF-32		51		700.000
40	FMVF-40		51		700.000
43	FMVF-43		51		700.000
50	FMVF-50		76		700.000
63	FMVF-63		76		920.000
80	FMVF-80		76		920.000
100	FMVF-100		76		920.000
125	FMVF-125		88		1.200.000

UKURAN DIAMETER KEPALA BESAR (55MM)



Ampere In (A)	Type	Dimension (mm)			Price (Rp)
		A	D	L	
12	FMCF-12	55	55	450	1.045.000
16	FMCF-16				1.045.000
20	FMCF-20				1.045.000
25	FMCF-25				1.045.000
31,5	FMCF-32				1.045.000
43	FMCF-43				1.045.000
50	FMCF-50				1.045.000
63	FMCF-63				1.210.000
80	FMCF-80				1.210.000
100	FMCF-100				1.210.000

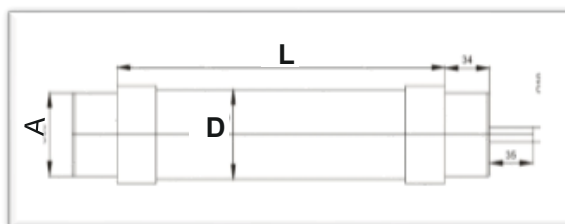

FUSE AND LIGHTNING ARRESTER



FUSE RAIL 3PHASE



Type	Ampere	For Fuse Link	Price (Rp)
FFR-160	160	NH-00	748.000
FFR-250	250	NH-1	1.650.000
FFR-400	400	NH-2	1.870.000
FFR-630	630	NH-3	2.827.000

FUSE BASE 3 PHASE

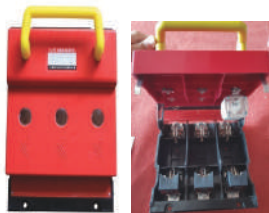

Type	Pole	Ampere (A)	For Fuse Link	Price (Rp)
HR6-160/30	3	160	NH-00	423.500
HR6-250/30	3	250	NH-1	862.400
HR6-400/30	3	400	NH-2	1.251.800
HR6-630/30	3	630	NH-3	1.430.000

LIGHTNING ARRESTER



Description	Material	Rated Voltage	Type	Price (Rp)
Arrester	Polymer	24kV/5kA	YH5W-24KV	1.029.000
		24kV/10kA	YH10W-24KV	1.102.500
	Porcelain / Cramic	24kV/5kA	Y5W-24KV	1.155.000
		24kV/10kA	Y10W-24KV	1.207.500

FUSE CUTOUT



Description	Material	Rated Voltage	Type	Price (Rp)
Fuse Cutout	Polymer	24kV/100A	HRW12-24/100	1.260.000

LOW VOLTAGE PLOYMERIC LIGHTNING ARRESTER



Description	Rated Voltage	Residual Voltage of Lightning Impluse	Type	Price (Rp)
Surge Arrester	0.28kV	1.3kV	FYH1.5W-0.28/1.3	60.000

FUSE LINK





Description	Ampere (A)	Type	Price (Rp)
Fuse Link untuk jaringan 20/24KV * K type	2, 4, 5, 6, 8, 10	F31002/10	28.300
	20, 25, 32, 40, 50	F31020/50	31.400
	63, 80, 100	F31063/100	43.200

Price List 2024

INSULATION CONNECTOR CABLE 1KV



Description	Model	Capacity Size (mm)		Type	Price (Rp)
		Main Line	Branch Line		
Insulation Piercing Connector * Material cover : PA66 * Material teeth : Aluminium * Material Screw : Galvanize * Voltage capacity : 1KV		16 - 95	1.5-10	KNEP	15.700
		16 - 95	4 - 50	KN2/95	23.200
		50 - 150	6 - 50	KN2/150	23.200
		25 - 95	25 - 95	KN3/95	28.700
		6 - 50	2.5 - 35	TTD101F	20.500
		25 - 95	2.5 - 35	TTD151F	20.500
		35 - 70	6 - 25	YN-2	21.400
		16 - 70	16 - 70	CPL-120	22.900
		25 - 95	25 - 95	TTD-301F	37.000

Description	Capacity		Type	Price (Rp)
Aluminium Parallel Groove Connector * Material Hight sterenght Aluminium alloy * Applicable for < 30KV 	AL 16 - 70	1 x M8	APG-A1	13.600
	AL 16 - 150	1 x M8	APG-A2	16.700
	AL 6 - 35	2 x M8	APG-B1	17.600
	AL 16 - 70	2 x M8	APG-B2	22.000
	AL 16 - 150	2 x M8	APG-B3	28.300
	AL 25 - 240	2 x M10	APG-B4	52.900
	AL 16 - 70	3 x M8	APG-C1	35.300
	AL 16 - 150	3 x M8	APG-C2	42.300
	AL 25 - 240	3 x M10	APG-C3	75.000
	AL 35 - 300	3 x M10	APG-C4	101.500

ANCHORING CLAMP/TENSION CLAMP



Description	Model	Capacity	Type	Price (Rp)
AL Anchoring Clamp/Tension Clamp * Material Hight sterenght Aluminium, nylon plus fiber glass and steel galvanize		Cross-section: 25~35mm ² Break Load: 12kN	PAL1000	75.400
		Cross-section: 50~70mm ² Break Load: 12kN	PAL1500	87.000
		Cross-section: 70~95mm ² Break Load: 15kN	PAL2000	91.000
Plastic Anchoring clamp * Material Nylon plus fiber glass & Steel Galvanize		Cross-section: 4x16~25mm ² Break Load: 3.5kN	STC	17.900
		Cross-section: 16~25mm ² Break Load: 3.5kN	PA2.1	31.600
		Cross-section: 25~50mm ² Break Load: 6kN	PA1500	75.400
		Cross-section: 50~70mm ² Break Load: 8kN	PA2000	97.500
Anchoring Bracket * Material Hight sterenght Aluminium alloy		Fixed by 2x 14/16mm bolts	KN81	36.600
Suspension Clamp / Klam Gantung * Material Hight sterenght Aluminium alloy		Cross-section: 16~95mm ²	SHC-5	80.000
		Cross-section: 16~95mm ²	ES54-14	66.700

ANALOG TEMPERATUR CONTROL



Description	Type	Dimension (mm)	Price (Rp)
TEMPERATUR CONTROL *Input signal : K *Output : Relay (0-400 °C) *Accuracy : 1.5 *Voltage : 110/220VAC, 50Hz	E5EM	48 X 96	290.000
	E5EN	48 X 96	308.000
	E5C2	48 X 48	196.000
	E5C4	48 X 48	345.000
	TEW	96 X 96	300.000
	K965	96 X 96	390.000
	K966	96 X 96	390.000
	K725	72 X 72	385.000
	K726	72 X 72	385.000

DIGITAL TEMPERATUR CONTROL



FTC SERIES



Description	Type	Size	Price (Rp)
* Input signal multi range K, J, S, B, E, Pt100, Cu50 * Ouput controll : Relay & SSR * Power 100 - 240VAC, 50Hz	FT-C100	48x48	390.000
	FT-C400	48x96	
	FT-C700	72x72	
	FT-C900	96x96	

CTN SERIES



Description	Type	Size	Price (Rp)
Digital Temperature Control * Input signal : thermocouple (K,J,RTD/Pt100) * Ouput controll : Relay & SSR * Input Voltage : 100 - 240VAC/50Hz	CTN4S	48 X 48	430.000
	CTN4V	48 X 96	430.000
	CTN4M	72 X 72	430.000
	CTN4L	96 X 96	458.000

DIGITAL THERMOMETER



Description	Model	Type	Size	Price (Rp)
Digital Thermometer * Input Voltage : 100 - 240VAC/50Hz * Display offset : -25°C to +150 °C	Bulat	ED16-22FTB	22	57.000
	Persegi	ED16-22FTK		

THERMOCOUPLE



Description	Cable Size (mm)	Screw Dia. (mm)	Type	Price (Rp)
Thermocouple, K / J type * Screw termocouple * Cable silver	5 X 2000mm	M6	FT-K/J-M6	27.900
	5 X 2000mm	M8	FT-K/J-M8	42.400
	5 X 2000mm	M10	FT-K/J-M10	48.300
Thermocouple, K / J type * Screw Long Size (model panjang) * Cable silver	5 X 2000mm	100 X M8	FTL-K/J-100	70.600
	5 X 2000mm	150 X M8	FTL-K/J-150	80.900
Thermocouple, Pt100 / RTD type * Screw termocouple * Cable PVC	5 X 2000mm	100 X M8	FT-PT-100	164.900
	5 X 2000mm	150 X M8	FT-PT-150	176.400

THERMOSTAT



THERMOSTAT (PENGATURAN SUHU)



CE RoHS



Description	Temperature Setting	Contact	Type	Price (Rp)
Mechanical Thermostat * Din rail type * Sensor element bimetal * Power : 110 - 250VAC/DC * Max. contact switch : 10A	0 to +60 °C	NO	KTS 011-F	65.000
	0 to +60 °C	NC	KTO 011-F	65.000
	0 to +60 °C	NO + NC	ZR011-F	170.000
Electronic Thermostat * Din rail type * Sensor element NTC * Power : 110 - 250VAC/DC * Max. contact switch : 10A	+5 to +60 °C	NO + NC	FZK011-F	413.000
	-20 to +35 °C	NO + NC	FZK011-F	413.000
Analog Thermostat * Panel mounting type * Max. contact switch : 16A	+30 to +110 °C	NO + NC	FTC-110	115.500
	+50 to +300 °C	NO + NC	FTC-300	115.500

HYGROSTAT (PENGATURAN KELEMBAPAN)



CE RoHS

Description	Humidity Setting	Contact	Type	Price (Rp)
Mechanical Hygrostat * Din rail type * Permissible air velocity : 15m/sec * Power : 110 - 250VAC/DC * Max. contact switch : 10A	35 to 95%RH	NO + NC	MFR-012-F	610.000

HEATER



CE RoHS

Description	Heating Capacity	Type	Price (Rp)
Semiconductor Heater * Din rail type * Voltage : 120-240VAC/DC * Heater element PTC resistor	50 watt	HG240-50W	356.000
	100watt	HG240-100W	529.000

RELAY



PROTECTION RELAY



Description	Type	Protection Function	Price (Rp)
Phase Protected Relay	APR-3	Phase reverse Phase sequence	163.000
	JVM-1	Phase reverse Phase sequence High voltage Phase failure	175.000
Under-Over Protection Relay 3-Phase/380VAC	FJD3	Under Voltage (300-380VAC), time delay 2.0 - 9.0sec Over Voltage (380-460VAC), time delay 1.5 - 4.0sec Phase Failure, max. 2sec Phase Sequence/Reverse, max. 2sec Contact Capacity : NO/NC, max 10A	330.000
Under-Over Protection Relay 1-Phase/220VAC, 50hz	FVPR-1P	Over Voltage : > 270V ± 5V Under Voltage : < 170V ± 5V Time Reset : 30s ± 2s In Max : 40A	95.000

SOCKET RELAY



Type	Pin	For Relay Type	Price (Rp)
PTF14A-E	14	LY-4	21.000
PF083A-E	8	H3BA-8,H3CR-A8,MK2P	7.300
PTF08A-E	8	LY-2	10.000
PYF08A-E	8	MY-2, H3Y	10.000
PYF14A-E	14	MY-4	11.600
PF113A-E	11	MK-3P	9.700
KLY2 (premium quality)	8	LY2	20.200
8PFA (with clip lock)	11	MK2P	29.100

RELAY



Type	Voltage (V)	Qty/pack	Price (Rp)
MY2	220VAC,24DC,12VDC	10	23.100
MY2N	220VAC,24DC,12VDC	10	26.300
LY2	220VAC,24DC,12VDC	10	23.100
LY2N	220VAC,24DC,12VDC	10	26.300
MY4	220VAC,24DC,12VDC	10	23.100
MY4N	220VAC,24DC,12VDC	10	26.300
LY4	220VAC,24DC,12VDC	10	41.000
LY4N	220VAC,24DC,12VDC	10	44.100
MK2P	220VAC,24DC,12VDC	10	34.700
MK3P	220VAC,24DC,12VDC	10	37.800

COUNTER



Description	Digit	Type	Price (Rp)
Counter Analog Voltage : 220AC, 50Hz	4	CSK4-YKW	118.000
	6	CKS6-YKW	131.000

Price List 2024

TIMER



DIN-RAIL TIMER



Description	Voltage (V)	Output Contact	Time Range	Type	Price (Rp)
Single function : *ON-delay Single time range	24-240VAC/DC	1 C/O (SPDT) 1x16A	30sec	FBT5-1-30s	114.000
			60sec	FBT5-1-60s	
		2 C/O (DPDT) 2x16A	30sec	FBT5-2-30s	128.000
			60sec	FBT5-2-60s	
Single function : * ON-delay Multi-time range	12-240VAC/DC	1 C/O (SPDT) 1x16A	0.1s-1s 1s-10s 6s-60s 1-10menit 0.1h-10h 1h-10h 0.1-1day 1-10day (On ,Off)	FBT7-B1	240.000
Single function : * OFF-delay Multi-time range	12-240VAC/DC	1 C/O (SPDT) 1x16A	0.1s-1s 1s-10s 6s-60s 1-10menit 0.1h-10h 1h-10h 0.1-1day 1-10day (On ,Off)	FBT7-C1	240.000
Multi function : A(On-delay), B(Interval), C(Repeat cycle-Off first), D(Repeat cycle-On first), E(Off-delay), F(Single short), G(Non-retriggerable single short), H(On/Off relay), I(Latching relay), J(Pulse generator). Multi-time range	12-240VAC/DC	1 C/O (SPDT) 1x16A	0.1s-1s 1s-10s 6s-60s 1-10menit 0.1h-10h 1h-10h 0.1-1day 1-10day (On ,Off)	FBT7-A1	270.000

HOUR METER



Description	Type	Price (Rp)
* Hour Meter Voltage : 24-240AC, 50Hz Timer Range: 0 - 99999h Insert type	BZ142	93.000

PHOTO SENSOR



Description	Type	Ampere (A)	Price (Rp)
Photo Electric Light Control, 220VAC	ASO-2206	6	68.800
	ASO-2210	10	
	AS-2206	6	48.000
	AS-2210	10	

TIMER



TIMER (PIN PLUG MOUNTING)



Description	Voltage (V)	Type	Price (Rp)
On delay (Omron model)	24 -240VAC/DC	H3CR-A8	209.000
	12 - 48VAC/DC	H3BA-8	125.000
Multi-function (Autonics model)	24-240VAC/DC	AT8-N	230.000
On delay Timer Range: 9.9S, 9.9M	220VAC/50Hz	ASY-2D (9.9S)	174.300
		ASY-2D (9.9M)	
On delay Timer Range: 99.9S, 99.9M	220VAC/50Hz	ASY-3D (99.9S)	191.000
		ASY-3D (99.9M)	
Twin Timer Timer Range : 60S*60S	220VAC/50Hz	ATDV-Y (60S*60S)	191.000
On delay Timer Range: 0.01 - 99.99 Second 0.01 - 99.99 minute 0.01 - 99.99 hour	220VAC/50Hz	DH48S-2Z	210.000
Setting time : 5S, 30S, 60S	220VAC	H3Y - 2	125.000
		H3Y - 4	125.000

TIMER (DIN-RAIL MOUNTING)



Type	Voltage (V)	Hour	Price (Rp)
SUL 181h	220VAC 45-60Hz	24h	241.000
SUL 181d	220VAC 45-60Hz	24h	316.000

DIGITAL WEEKLY TIMER



Description	Type	Price (Rp)
Weekly Digital Timer : * Voltage : 220-240AC, 50/60Hz * Timer Setting Range: 1min - 168hours * Auxiliary Contact : 1NO 1NC * LCD Display	TP8A16	207.000
	FG-316T	200.000

Price List 2024

WATER TANK CONTROL



FLOAT SWITCH / RADAR



Type	Description	Length Cable	Price (Rp)
YXF-A	Voltage : 220VAC, 50Hz	2M	83.000
	Include cable 3X0.75mm	5M	124.000
SL-70AB	Voltage : 220VAC, 50Hz		73.000

WATER LEVEL CONTROL



Type	Description	Voltage	Price (Rp)
61F-G-AP	For 1 water tank	110/220VAC, 50/60Hz	285.000
61F-G2-AP	For 2 water tank		326.000
FAFR-1	For 1 water tank	220VAC, 50/60Hz	162.000
FBL7-B1	For 1 water tank 1C/O (SPDT)	24-240VAC/DC 50/60Hz	160.000
FBL7-B2	For 2 water tank 1C/O (SPDT)		200.000

SENSOR FOR WATER LEVEL CONTROL



Description	Price (Rp)
Elektrode Lilin	27.000

PRESSURE PUMPS SENSOR

PRESSURE TRANSMITTER



Description	Type	Price (Rp)
* Range : 0 - 10bar * Input : 10 - 30VDC * Output : 4 - 20mA * Pressure Port : G 1/4 * Protection Grade : IP67	LFT2000	630.000

PRESSURE SWITCH / HIDROPHORE SEQUENCING RELAY







Description	Type	Price (Rp)
* Operating Voltage N-L : 150 - 250VAC * Contact Relay max. 3A/250VAC * Contact Output for : 2 Pumps (H1,H2) * Frequency : 50/60Hz	FHSR-22	430.000

LIMIT SWITCH



TZ LIMIT SWITCH

	Type	Price (Rp)
	TZ-8104	89.800
	TZ-8107	89.800
	TZ-8108	89.800
	TZ-8111	80.600
	TZ-8112	80.600





	Type	Price (Rp)
	TZ-8122	80.600
	TZ-8166	87.200
	TZ-8167	87.200
	TZ-8168	87.200
	TZ-8169	87.200

LIMIT SWITCH



CWL LIMIT SWITCH





	Type	Price (Rp)
	CWLCA2-2	191.000
	CWLCA12-2-Q	191.000
	CWLCA32-41	240.000
	CWLNJ-2	189.000

	Type	Price (Rp)
	CWLD2	189.000
	CWLD	189.000
	CWLCL	220.500
	CWLNJ-S2	189.000

MICRO SWITCH



CZ MICRO SWITCH

	Type	Price (Rp)
	CZ-7140	46.100
	CZ-7141	46.100
	CZ-7120	46.100
	CZ-7121	46.100
	CZ-7124	54.600
	CZ-7144	54.600
	CZ-7310	57.800
	CZ-7311	62.200

CM MICRO SWITCH

	Type	Price (Rp)
	CM-1701	36.300
	CM-1702	36.300
	CM-1703	36.300
	CM-1704	36.300
	CM-1306	45.900
	CM-1307	45.600
	CM-1308	52.000
	CM-1309	52.000

MICRO SWITCH



CS MICRO SWITCH



Type	Price (Rp)
CMV-100-D (CS10N001C2)	10.000
CMV-101-D (CS10N021C2)	10.000
CMV-103-D (CS10N061C2)	11.400



Type	Price (Rp)
CMV-102-D (CS10N011C2)	10.000
CMV-104-D (CS10N051C2)	11.400

TOGGEL SWITCH



Type	Kaki	Ampere (A)	Name plate	Price (Rp)
1021	2	15	ON - OFF	10.000
1122	3	15	ON - OFF - ON	10.000
1221	4	15	ON - OFF	12.000
1322	6	15	ON - OFF - ON	12.000

MONOLEVER SWITCH / JOYSTICK



Type	Model	Contact	Position	Price (Rp)
CS-2011	Stay put	2 NO	Up - Down	83.000
CS-201	Spring Return	2 NO	Up - Down	83.000
CS-4022	Stay put	2NO + 2NC	Up - Down - Right - Left	114.000
CS-402	Spring Return	2NO + 2NC	Up - Down - Right - Left	114.000

FOOT SWITCH



Type	Price (Rp)
CFS-302	221.000
CFS-402	205.000
VFS-201/CFS-201	56.000
FS-5/CFS-01	48.000



Type	Price (Rp)
CFS-2 (premium)	102.000
FS-2 (economic)	60.000
CFS-3 (premium)	121.000
FS-3 (economic)	74.000
FS-1/CFS-1	59.000

SOLID STATE RELAY SSR



DC - AC, SOLID STATE RELAY



Model	Input Voltage	Output Volatge	Ampere (A)	Type	Qty/box	Price /Pcs (Rp)
1 Phase	4 - 32VDC	24 - 480 VAC	10	FSSR-10DA	10	98.800
			25	FSSR-25DA	10	113.500
			40	FSSR-40DA	10	134.600
			60	FSSR-60DA	10	245.700
			80	FSSR-80DA	10	315.900
			100	FSSR-100DA	10	359.200
3 Phase	4 - 32VDC	24 - 480 VAC	10	FTSSR-10DA	6	327.600
			25	FTSSR-25DA	6	386.100
			40	FTSSR-40DA	6	432.900
			60	FTSSR-60DA	6	741.800
			80	FTSSR-80DA	6	795.600
			100	FTSSR-100DA	6	971.100
			120	FTSSR-120DA	6	1.100.000

AC - AC, SOLID STATE RELAY



Model	Input Voltage	Output Volatge	Ampere (A)	Type	Qty/box	Price /Pcs (Rp)
1 Phase	90 - 250VAC	24 - 480 VAC	10	FSSR-10AA	10	98.800
			25	FSSR-25AA	10	113.500
			40	FSSR-40AA	10	134.600
			60	FSSR-60AA	10	245.700
			80	FSSR-80AA	10	315.900
			100	FSSR-100AA	10	409.000
3 Phase	90 - 250VAC	24 - 480 VAC	10	FTSSR-10AA	6	327.600
			25	FTSSR-25AA	6	386.100
			40	FTSSR-40AA	6	432.900
			60	FTSSR-60AA	6	741.800
			80	FTSSR-80AA	6	795.600
			100	FTSSR-100AA	6	971.100
			120	FTSSR-120AA	6	1.100.000

Price List 2024

PROXIMITY SENSORS



CYLINDRICAL INDUCTIVE PROXIMITY SENSOR (3 WIRES) CABLE TYPE



Operating Voltage	Dimension (mm)	Sensing Distance	Output		Type	Cross Reference		Price (Rp)
						Omron	Autonics	
10 - 30VDC	M8	1mm	NPN	NO	CJY08E-01NA	E2E-X1R5E1	PR08-1.5DN	91.900
		2mm	NPN	NO	CJY08E-02NA	E2E-X2ME1	PR08-2DN	
10 - 30VDC	M12	2mm	NPN	NO	CJY12E-02NA	E2E-X2E1	PR12-2DN	85.600
			NPN	NC	CJY12E-02NB	E2E-X2E2	PR12-2DN2	
			PNP	NO	CJY12E-02PA	E2E-X2F1	PR12-2DP	
			PNP	NC	CJY12E-02PB	E2E-X2F2	PR12-2DP2	
	4mm	NPN	NO	CJY12E-04NA	E2E-X5ME1	PR12-4DN	85.600	
		NPN	NC	CJY12E-04NB	E2E-X5ME2	PR12-4DN2		
		PNP	NO	CJY12E-04PA	E2E-X5MF1	PR12-4DP		
		PNP	NC	CJY12E-04PB	E2E-X5MF2	PR12-4DP2		
10 - 30VDC	M18	5mm	NPN	NO	CJY18E-05NA	E2E-X5E1	PR18-5DN	97.700
			NPN	NC	CJY18E-05NB	E2E-X5E2	PR18-5DN2	
			PNP	NO	CJY18E-05PA	E2E-X5F1	PR18-5DP	
			PNP	NC	CJY18E-05PB	E2E-X5FE	PR18-5DP2	
	8mm	NPN	NO	CJY18E-08NA	E2E-X10ME1	PR18-8DN	97.700	
		NPN	NC	CJY18E-08NB	E2E-X10ME2	PR18-8DN2		
		PNP	NO	CJY18E-08PA	E2E-X10MF1	PR18-8DP		
		PNP	NC	CJY18E-08PB	E2E-X10MF2	PR18-8DP2		
10 - 30VDC	M30	10mm	NPN	NO	CJY30E-10NA	E2E-X10E1	PR30-10DN	121.700
		15mm	NPN	NO	CJY30E-15NA	E2E-X18ME1	PR30-15DN	121.700

CYLINDRICAL INDUCTIVE PROXIMITY SENSOR (3 WIRES) CONNECTOR TYPE



Operating Voltage	Dimension (mm)	Sensing Distance	Output		Type	Cross Reference		Price (Rp)
						Omron	Autonics	
10 - 30VDC	M12	2mm	NPN	NO	CJY12E-02NA-T	E2E-X2E1-M1	PRCM12-2DN	125.800
		4mm	NPN	NO	CJY12E-04NA-T	E2E-X5ME1-M1	PRCM12-4DN	125.800
	M18	5mm	NPN	NO	CJY18E-05NA-T	E2E-X5E1-M1	PRCM18-5DN	151.500
		8mm	NPN	NO	CJY18E-08NA-T	E2E-X10ME1-M1	PRCM18-8DN	151.500
	M30	10mm	NPN	NO	CJY30E-10NA-T	E2E-X10E1-M1	PRCM30-10DN	213.600
		15mm	NPN	NO	CJY30E-15NA-T	E2E-X15ME1-M1	PRCM30-15DN	213.600

PROXIMITY SENSORS



SQUARE INDUCTIVE PROXIMITY SENSOR (3 WIRES) CABLE TYPE

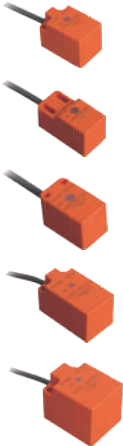

Operating Voltage	Dimension (mm)	Sensing Distance	Output		Type	Cross Reference		Price (Rp)
						Omron	Autonics	
10 - 30VDC	17x17x28	5mm	NPN	NO	CJF17E-05NA	TL-Q5MC1	-	60.300
			NPN	NC	CJF17E-05NB	TL-Q5MC2	-	
			PNP	NO	CJF17E-05PA	TL-Q5MB1	-	
10 - 30VDC	18x18x36.2	5mm	NPN	NO	CJF18E-05NA	-	PSN17-5DN	60.300
			NPN	NC	CJF18E-05NB	-	PSN17-5DN2	
			PNP	NO	CJF18E-05PA	-	PSN17-5DP	
10 - 30VDC	25x25x39.2	8mm	NPN	NO	CJF25E-08NA	TL-N5ME1	PSN25-5DN	79.700
			NPN	NC	CJF25E-08NB	TL-N5ME2	PSN25-5DN2	
			PNP	NO	CJF25E-08PA	-	PSN25-5DP	
10 - 30VDC	30x30x53.2	12mm	NPN	NO	CJF30E-12NA	TL-N10ME1	PSN30-10DN	103.800
			PNP	NO	CJF30E-12PA	TL-N10ME2	PSN30-10DP	
10 - 30VDC	40x40x53	15mm	NPN	NO	CJF40E-15NA	TL-N20ME1	PSN40-15DN	127.800
			PNP	NO	CJF40E-15PA	TL-N20ME2	PSN40-15DP	

CYLINDRICAL INDUCTIVE PROXIMITY SENSOR (3 WIRES) CABLE TYPE (LONG DISTANCE SENSING)



Operating Voltage	Dimension (mm)	Sensing Distance	Output		Type	Cross Reference		Price (Rp)
						Omron	Autonics	
10 - 30VDC	M12	4mm	NPN	NO	CJY12S-04NA	E2EM-X4C1	PRD12-4DN	210.800
		7mm	NPN	NO	CJY12S-07NA	-	PRD12-8DN	
10 - 30VDC	M18	10mm	NPN	NO	CJY18S-10NA	E2EM-X8C1	PRD18-7DN	228.100
		15mm	NPN	NO	CJY18S-15NA	-	PRD18-14DN	

CYLINDRICAL CAPACITIVE PROXIMITY SENSOR (3 WIRES) CABLE TYPE



Operating Voltage	Dimension (mm)	Sensing Distance	Output		Type	Cross Reference		Price (Rp)
						Omron	Autonics	
10 - 30VDC	M12	4mm	NPN	NO	CRY12-04NA	-	CR12-4DN	231.800
			NPN	NC	CRY12-04NB	-	CR12-4DN2	
10 - 30VDC	M18	8mm	NPN	NO	CRY18-08NA	-	CR18-8DN	195.600
			NPN	NC	CRY18-08NB	-	CR18-8DN2	
10 - 30VDC	M30	15mm	NPN	NO	CRY30-15NA	E2K-C25ME1	CR30-15DN	246.200
			NPN	NO	CRY30-15NB	E2K-C25ME2	CR30-15DN2	

PHOTOELECTRIC SENSORS



CYLINDRICAL TYPE PHOTOELECTRIC SENSOR (3 WIRES)

Operating Voltage	Dimension (mm)	Sensing Distance	Output		Type	Cross Reference		Price (Rp)
						Omron	Autonics	
DIFFUSE-REFLECTIVE TYPE								
10 - 30VDC	M18	30cm (Adjustable)	NPN	NO	CGY18E-D30NA	E3F2-DS30C42M	BRP400-DDT	186.600
			NPN	NC	CGY18E-D30NB	E3F2-DS30C4P1	BRP400-DDT	
			PNP	NO	CGY18E-D30PA	E3F2-DS30B42M	BRP400-DDT-P	
10 - 30VDC	M30	70cm (Adjustable)	NPN	NO	CGY30E-D70NA	-	-	228.100
			NPN	NC	CGY30E-D70NB	-	-	
			PNP	NO	CGY30E-D70PA	-	-	
RETRO-REFLECTIVE TYPE								
10 - 30VDC	M18	2m	NPN	NO	CGY18E-R2NA	E3F2-R4C4-E2M	BR3M-MDT	200.000
			NPN	NC	CGY18E-R2NB	E3F2-R4C4-P1E	BR3M-MDT	
			PNP	NO	CGY18E-R2PA	E3F2-R4B4-E2M	BR3M-MDT-P	
10 - 30VDC	M30	4m	NPN	NO	CGY30E-R4NA	-	-	242.000
			NPN	NC	CGY30E-R4NB	-	-	
			PNP	NO	CGY30E-R4PA	-	-	
THROUGH-BETHOD TYPE								
10 - 30VDC	M18	5m	NPN	NO	CGY18E-T5NA	E3F2-7C42M	BR4M-TDTD	290.000
			NPN	NC	CGY18E-T5NB	E3F2-7C4-P1	BR4M-TDTD	
			PNP	NO	CGY18E-T5PA	E3F2-7B42M	BR4M-TDTD-P	
10 -30VDC	M30	10m	NPN	NO	CGY30E-T10NA	-	-	331.700
			NPN	NC	CGY30E-T10NB	-	-	
			PNP	NO	CGY30E-T10PA	-	-	

U TYPE PHOTOELECTRIC SENSOR (3 WIRES)



Operating Voltage	Dimension (mm)	Sensing Distance	Output		Type	Cross Reference		Price (Rp)
						Omron	Autonics	
10 - 30VDC	7	7mm	NPN	NO	CGU07E-07NA	-	-	186.600
	10	10mm	NPN	NO	CGU10E-10NA	E3S-GS1RE4	-	186.600
	30	30mm	NPN	NO	CGU30E-30NA	E3S-GS3E4	BUP-30	207.400
	50	50mm	NPN	NO	CGU50E-50NA	-	BUP-50	221.300

PHOTO PHOTOELECTRIC SENSORS CYLINDRICAL TYPE

Diffuse-Reflective type	Retro-Reflective type	Through-Bethod type
 CGY18E-D	 CGY18E-R	 CGY18E-T
 CGY30E-D	 CGY30E-R	 CGY30E-T

PHOTOELECTRIC SENSORS



SQUARE PHOTOELECTRIC SENSOR (3 WIRES)

Operating Voltage	Dimension (mm)	Sensing Distance	Output		Type	Cross Reference		Price (Rp)
						Omron	Autonics	
Diffuse-Reflective type								
24-240VAC/DC	50x50	30cm (Adjustable)	Relay	NO+NC	CGF50-D30JC	E3JK-DR13-C2M	BEN300-DFR	311.100
10-30VDC			NPN	NO	CGF50E-D30NA	E3JK-DN13-2M	BEN300-DDT	186.600
			PNP	NO	CGF50E-D30PA	E3JK-DP13-2M	BEN300-DDT-P	186.600
24-240VAC/DC	70x70	50cm (Adjustable)	Relay	NO+NC	CGF70-D50JC	-	-	380.100
10-30VDC			NPN	NO	CGF70E-D50NA	-	-	248.800
			PNP	NO	CGF70E-D50PA	-	-	248.800
Retro-Reflective type								
24-240VAC/DC	50x50	4m	Relay	NO+NC	CGF50-R4JC	E3JK-RR13-C2M	BEN5M-MFR	366.400
10-30VDC			NPN	NO	CGF50E-R4NA	E3JK-RN13 2M	BEN5M-MDT	200.400
			PNP	NO	CGF50E-R4PA	E3JK-RP13 2M	BEN5M-MDT-P	200.400
24-240VAC/DC	70x70	5m	Relay	NO+NC	CGF70-R5JC	-	-	428.400
10-30VDC			NPN	NO	CGF70E-R5NA	-	-	269.600
			PNP	NO	CGF70E-R5PA	-	-	269.600
Through-Bethod type								
24-240VAC/DC	50x50	10m	Relay	NO+NC	CGF50-T10JC	E3JK-TR14-C 2M	BEN10M-TFR	463.100
10-30VDC			NPN	NO	CGF50E-T10NA	E3JK-TN14 2M	BEN10M-TDT	290.400
			PNP	NO	CGF50E-T10PA	E3JK-TP14 2M	BEN10M-TD-P	290.400
24-240VAC/DC	70x70	15m	Relay	NO+NC	CGF70-T15JC	-	-	566.700
10-30VDC			NPN	NO	CGF70E-T15NA	-	-	380.000
			PNP	NO	CGF70E-T15PA	-	-	380.000

SENSOR ACCESSORY

Description	Dimension	Cable	Type	Price (Rp)
Plug for Sensor	12mm	4-core, 5 meter	CSD-PS1204-5	74.500
		4-core, 10 meter	CSD-PS1204-10	113.000



PHOTO PHOTOELECTRIC SENSORS

Diffuse-Reflective type	Retro-Reflective type	Through-Bethod type
<p>CGF50 E-D</p>	<p>CGF50 E-R</p>	<p>CGF50 E-T</p>
<p>CGF70 E-D</p>	<p>CGF70 E-R</p>	<p>CGF70 E-T</p>

BUZZER



Description	Diameter (mm)	Voltage (V)	Type	Price (Rp)
Buzzer	16	220VAC 24VDC	SDL16-MF (w/o lamp) AD22-16MSD (with lamp)	27.800
Buzzer With Lamp	22	380VAC 220VAC 24VDC	AD22-22MSD	27.800
Panel mounting	30 / 25	220VAC 24VDC	HRB-60/PS30	45.900
Panel mounting Buzzer	80 X 80	220VAC 24VDC	HRB-P80	63.300
Outbox Buzzer	65mm	220VAC 24VDC	HRB-N80	60.500
Bell	4 "	220VAC	FTB-4	143.800
	6 "		FTB-6	279.000

MOTOR SIREN (SIRENE)



Voltage	Sound Pressure	Capacity (Watt)	Colour	Type	Price (Rp)
220VAC, 24 VDC 12VDC	90-110dB	120	Red (metal case)	MS-190M	115.500
220VAC, 24 VDC	100-112dB	180	Grey (metal case)	MS-290A	229.400
220VAC, 50Hz	100-116dB	130	Red (metal case)	MS-390	525.500
220VAC, 50Hz	110-120dB	300	Red (metal case)	MS-490	1.545.600
220VAC, 50Hz	110-125dB	320	Red (metal case)	MS-590 (S-293)	3.839.900
220VAC, 50Hz	120-130dB	1200	Red (metal case)	MS-690 (S-303)	6.762.000
220VAC, 50Hz	120-150dB	1200	Red (metal case)	MS-790 (S-313)	7.000.000

LIGHTING



LAMPU MENARA / TOWER LAMP

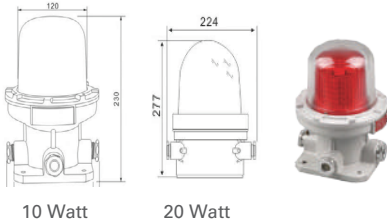

10 Watt

20 Watt

Description	Type	Capacity	Color	Price (Rp)
Tower Lamp LED : * 220VAC, 50/60Hz * IP 66 * Function : Flashing	BSZD81-10	10 Watt	Red	2.950.000
	BSZD81-20	20 Watt	Red	4.420.000

EXPLOSION PROOF WARING LAMP



BBJ-90

BBJ-120

BBJ-180

Description	Type	Capacity Sirene	Color	Price (Rp)
Rotary Lamp LED : * 220VAC, 50/60Hz * IP 66 * Function : Rotary * With Sirene	BBJ-90	90 db	Red	703.500
	BBJ-120	120 db	Red	1.365.000
	BBJ-180	180 db	Red	3.150.000

INDUSTRIAL PORTABLE LIGHT BASE



Type	Length	Price (Rp)
FT-PL-5	5 M	80.000
FT-PL-10	10 M	111.000

LED LAMP T5



Description	Power	Type	Price (Rp)
Lampu LED T5 buat Box Panel * Bisa diseri sampai 15 lampu * Dilengkapi dengan Magnet buat kedudukan di box panel * Input Voltage : 180 - 265 VAC * Lumen Output : 450lm * Sertifikat :	5watt (30cm)	FT5-1005L	65.000
	10watt (60cm)	FT5-1010L	75.000

TOWER AND WARNING LIGHT



TOWER LIGHT (LAMPU LED)

Description	Voltage	Colour	Multifunction	Type	Price (Rp)
1 Lamp LED	220VAC	Red	Flashing Steady	AL50E-1-31P2	228.800
2 Lamp LED		Red, Yellow		AL50E-2-31P2	300.700
3 Lamp LED	24VDC	Red, Yellow, Green		AL50E-3-31P2	371.600



TOWER LIGHT (LAMPU LED) WITH BUZZER

Description	Voltage	Colour	Multifunction	Type	Price (Rp)
1 Lamp LED	220VAC	Red	Flashing Steady	AL50E-1M-31P2	251.200
2 Lamp LED		Red, Yellow		AL50E-2M-31P2	322.400
3 Lamp LED	24VDC	Red, Yellow, Green		AL50E-3M-31P2	392.500

WARNING LIGHT (LAMPU LED)

Description	Size	Colour	Multifunction	Type	Price (Rp)
Multi voltage : 220VAC,12VDC,24VDC	4"	Red, Yellow, Blue, Green	Rotary Flashing Steady	LTD-1101M-LED	110.300
	5"			LTD-5121M-LED	207.000



WARNING LIGHT (LAMPU LED) WITH BUZZER

Description	Size	Colour	Multifunction	Type	Price (Rp)
Multi voltage : 220VAC,12VDC,24VDC	4"	Red, Yellow, Blue, Green	Rotary Flashing Steady	LTD-1101MJ-LED	117.600
	5"			LTD-5121MJ-LED	225.000

WARNING LIGHT (LAMPU LED)

Description	Size	Colour	Function	Type	Price (Rp)
Multi voltage : 12VDC & 24VDC * Magnet Base	4"	Red, Yellow	Flashing	LTE-5095	150.000



MINIATURE SIGNAL LIGHT (LAMPU LED)

Voltage	Size	Colour	Function	Type	Price (Rp)
220VAC	30mm	Red	Steady	S-TX	117.800



TOWER AND WARNING LIGHT



TOWER LIGHT (LAMPU NEON)



Description	Colour	Type	Price (Rp)	
			Steady	Flicker
1 Lamp, 220VAC direct	Red	STA-205-1	151.200	230.000
2 Lamp, 220VAC direct	Red, Yellow	STA-205-2	189.000	265.700
3 Lamp, 220VAC direct	Red, Yellow, Green	STA-205-3	241.500	314.000

TOWER LIGHT (LAMPU NEON) WITH BUZZER



Description	Colour	Type	Price (Rp)	
			Steady + Buzzer	Flicker + Buzzer
1 Lamp, 220VAC direct	Red	STA-205-1J	254.100	278.300
2 Lamp, 220VAC direct	Red, Yellow	STA-205-2J	302.400	325.500
3 Lamp, 220VAC direct	Red, Yellow, Green	STA-205-3J	329.700	386.400

WARNING LIGHT (LAMPU NEON)



Voltage	Size	Colour	Type	Price (Rp)
220VAC,12VDC,24VDC	4"	Red, Yellow, Blue	LTE-1101	103.800
220VAC,12VDC,24VDC	5"	Red, Yellow, Blue	LTE-1121	136.400
220VAC,12VDC,24VDC	6"	Red, Yellow, Blue	LTE-1161	303.500

WARNING LIGHT (LAMPU NEON) WITH BUZZER



Voltage	Size	Colour	Type	Price (Rp)
220VAC,12VDC,24VDC	4"	Red, Yellow, Blue	LTE-1101J	144.900
220VAC,12VDC,24VDC	5"	Red, Yellow, Blue	LTE-1121J	169.100
220VAC,12VDC,24VDC	6"	Red, Yellow, Blue	LTE-1161J	446.300

PLUG & SOCKET



DIN RAIL STOP KONTAK



Description	Type	Price (Rp)
Din rail stop kontak, 16A/250V	FTK-250	39.200

FLOOR SWITCH / STOP KONTAK LANTAI



Description	Type	Price (Rp)
Socket 2P+N & socket 2P	FFS-32	330.000
Socket 2P+N & Socket computer (DATA)	FFS-32C	
Socket 2P+N & Socket TLP	FFS-32T	
Socket 2P + 8Pin + 4Pin	FFS-32CT	
Universal Socket + Socket 2P	FFS-32U	330.000
Universal Socket + Socket TLP	FFS-32UT	
Universal Socket + Socket computer (DATA)	FFS-32UC	

HEAVY DUTY CONNECTOR (IP 65)

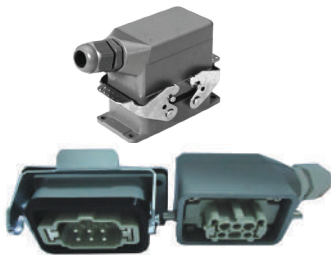

Type	Pin	Price (Rp) / Set
CHD-6	6	434.700
CHD-10	10	676.200
CHD-16	16	772.800
CHD-24	24	977.600
CHD-32	32	1.352.400

CABLE ROLL



Type	Description	Length (M)	Price (Rp)
QB-DXW02	Kable Roll, 3 X 1mm	25	622.000
QB-DXW01	Kable Roll, 3 X 1.5mm	50	1.100.000

INDUSTRIAL DISTRIBUTION BOX



Description	Type	Price (Rp)
3 Way Distribution Box * Box Material ABS, IP67 * Volatge : 220-250VAC / 16A * Plug & Socket : 3 Pole/16A, IP44 * ELCB 2P/25A, Himel (SNI) * MCB 1P/16A, Himel (SNI) * Include cable 3X2.5mm, 2Meter (SNI)	FT-ZH1802-A	1.350.000

INDUSTRIAL PLUGS & SOCKETS IP 67



INDUSTRIAL PLUG



Type	Pole	Ampere	Price (Rp)
FT-0132	3	16	48.300
FT-0142	4		64.100
FT-0152	5		74.600
FT-0232	3	32	80.900
FT-0242	4		92.400
FT-0252	5		104.000
FT-0332	3	63	237.300
FT-0342	4		257.300
FT-0352	5		278.300
FT-0432	3	125	652.100
FT-0442	4		664.100
FT-0452	5		700.400

MOBILE SOCKET



Type	Pole	Ampere	Price (Rp)
FT-2132	3	16	64.100
FT-2142	4		69.300
FT-2152	5		80.900
FT-2232	3	32	104.000
FT-2242	4		115.500
FT-2252	5		131.300
FT-2332	3	63	338.100
FT-2342	4		354.900
FT-2352	5		362.300
FT-2432	3	125	676.200
FT-2442	4		712.400
FT-2452	5		719.700

WALL SOCKET



Type	Pole	Ampere	Price (Rp)
FT-1132	3	16	80.900
FT-1142	4		87.200
FT-1152	5		98.700
FT-1232	3	32	115.500
FT-1242	4		127.100
FT-1252	5		138.600
FT-1332	3	63	359.100
FT-1342	4		372.800
FT-1352	5		380.100
FT-1432	3	125	688.300
FT-1442	4		724.500
FT-1452	5		736.600

MULTIPLE PLUG & SOCKET

Type	Pole	Ampere	Price (Rp)
FT-10132	3	16	311.900



INDUSTRIAL PLUGS & SOCKETS IP44



INDUSTRIAL PLUG



Type	Pole	Ampere	Price (Rp)
013	3	16	24.200
014	4	16	29.400
015	5	16	36.800
023	3	32	41.000
024	4	32	44.100
025	5	32	55.700
033	3	63	204.800
034	4	63	238.400
035	5	63	253.100

WALL SOCKET



Type	Pole	Ampere	Price (Rp)
113	3	16	34.700
114	4	16	41.000
115	5	16	46.200
123	3	32	47.300
124	4	32	51.500
125	5	32	60.900
133	3	63	329.700
134	4	63	362.300
135	5	63	380.100

MOBILE SOCKET



Type	Pole	Ampere	Price (Rp)
213	3	16	31.500
214	4	16	35.700
215	5	16	48.300
223	3	32	44.100
224	4	32	49.400
225	5	32	58.800

PANEL SOCKET



Type	Pole	Ampere	Price (Rp)
313	3	16	33.600
314	4	16	39.900
315	5	16	48.300
323	3	32	44.100
324	4	32	49.400
325	5	32	60.900

INDUSTRIAL PLUG 2POLE



Type	Pole	Ampere	Price (Rp)
012	2P+E	16A/250V	24.200
FT-012-B			13.700

MOBILE SOCKET 2 POLE



Type	Pole	Ampere	Price (Rp)
212	2P+E	16A/250V	29.400
FT-212-B			14.700

INDUSTRIAL PLUG & SOCKET (CABANG 3)



Type	Pole	Ampere	Price (Rp)
CEE-1013	3	16	157.500
CEE-1014	4	16	181.700
CEE-1023	3	32	314.000
CEE-1024	4	32	408.500

PANEL SOCKET 2 POLE



Type	Pole	Ampere	Price (Rp)
112	2	16A/250V	30.500

DIN RAIL TERMINAL BLOCK



RAIL TYPE TERMINAL BLOCK (MODEL KASUGA, WARNA HITAM) (PEMAKAIAN DI RAIL 2 FUNGSI)



Description	Ampere (A)	Type	Price (Rp)
Terminal blok	10	CBC-10	1.800
Terminal blok	20	CBC-20	2.400
Terminal blok	30	CBC-30	3.200
Terminal blok	60	CBC-60	10.500
End plate	end plate for CBC-10		1.800
End plate	end plate for CBC-20		1.900
End plate	end plate for CBC-30		2.200
End plate	end plate for CBC-60		2.300
Stopper	GK-808-1		1.800

RAIL TYPE TERMINAL BLOCK (MODEL TEND) (PEMAKAIAN DI RAIL 1 FUNGSI)



Description	Ampere (A)	Type	Price (Rp)
Terminal blok	10	CBR-10A	1.800
	20	CBR-20A	2.400
	30	CBR-30A	3.000
	60	CBR-60A	11.900
	100	CBR-100A	25.900
End plate	end plate for CBR-10 to CBR-30		1.800
	end plate for CBR-60		3.600
	end plate for CBR-100		3.800
Stoper	stoper for CBR (CBR-F)		2.000

RAIL TYPE TERMINAL BLOCK (MODEL KASUGA, WARNA COKLAT) (PEMAKAIAN DI RAIL 2 FUNGSI)



Description	Ampere (A)	Type	Price (Rp)
Terminal blok	10	TR-10	4.500
Terminal blok	20	TR-20	5.000
Terminal blok	30	TR-30	11.900
Terminal blok	60	TR-60	15.400
Terminal blok	100	TR-100	38.000
End plate	end plate for TR-10		2.900
	end plate for TR-20		3.000
	end plate for TR-30		3.200
	end plate for TR-60		3.900
	end plate for TR-100		4.600
Stoper	stoper for TR (TR-K)		2.100

LEVELING TERMINAL BLOCK (PEMAKAIAN DI RAIL 1 FUNGSI) TERMINAL BLOCK 2 SUSUN



Description	Ampere (A)	Type	Price (Rp)
Terminal blok, 2 tingkat	10	TBD-10A	6.100
Terminal blok, 2 tingkat	20	TBD-20A	7.200
End plate	end plate for TBD-10, TBD-20		1.900

DIN RAIL TERMINAL BLOCK



TERMINAL BLOCK TYPE UK (GREY)



Type	Screw	Wire cable Range	Price (Rp)
TUK 3N	M3	2,5mm	3.300
TUK 5N	M3	4mm	4.000
TUK 6N	M4	6mm	5.800
TUK 10N	M4	10mm	7.900
TUK 16N	M4	16mm	12.700
TUK 35N	M4	35mm	27.300

TERMINAL BLOCK TYPE UK (COLOR YELLOW-GREEN)



Type	Screw	Wire cable Range	Price (Rp)
TUSLKG 3	M3	2,5mm	10.400
TUSLKG 5	M3	4mm	12.100
TUSLKG 6	M4	6mm	15.200
TUSLKG 10	M4	10mm	21.500
TUSLKG 16	M4	16mm	27.300
TUSLKG 35	M4	35mm	38.000

TERMINAL BLOCK UK TYPE (GREY)

MTK-P/P

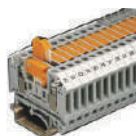

UKK-3N

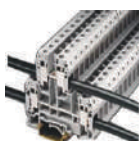

Description	Wire cable Range (mm)	Type	Price (Rp)
Disconnecter terminal UK (ada soket pemutus)	0.2 - 4mm	MTK-P/P	22.600
Double level terminal block UK (2 tingkat terminal)	2.5 mm	UKK-3N	15.800
	4 mm	UKK-5N	17.900
End cover for UKK-3N, 5N			3.900

ACCESORIES FOR TERMINAL UK

E/CUK



SUK-E



JUMPER



STRIP NUMBER



Description	Type	FOR	Price (Rp)
End cover/end plate	D-TUK3/10	TUK 3N to TUK 10N	1.900
	D-TUK16	TUK 16N	2.000
Stoper for terminal UK	E/CUK	TUK3N to TUK35N	2.400
	SUK-E		2.900
Separator	TUK-B1	TUK 3N to TUK 10N	4.000
Jumper / Fixed Bridge per strip 10pcs	TFBI 10-5	FOR TUK3N	17.800
	TFBI 10-6	FOR TUK5N	17.800
	TFBI 10-8	FOR TUK6N	28.900
	TFBI 10-10	FOR TUK10N	40.400
	TFBI 10-12	FOR TUK16N	44.000
Strip Number	ZB5	FOR TUK3N	4.200
	ZB6	FOR TUK5N	
	ZB8	FOR TUK6N	
	ZB10	FOR TUK10N	
	ZB12	FOR TUK16N	

DISCONNECT TERMINAL BLOCK



Wire cable Range (mm)	Type	Price (Rp)
0.5 - 10mm	URTK/S	25.200
End cover for URTK/S		3.400

TERMINAL BLOCK



TERMINAL BLOCK TC



Pole	Ampere	Type	Price (Rp)
3	60	TC - 603	18.500
4	60	TC - 604	23.700
3	100	TC - 1003	35.600
4	100	TC - 1004	38.600
3	150	TC - 1503	61.200
4	150	TC - 1504	69.300
4	200	TC - 2004	86.600
4	300	TC - 3004	213.700
4	400	TC - 4004	231.000

TERMINAL BLOCK TB



Pole	Ampere	Type	Price (Rp)
3	15	TB - 1503	2.400
4	15	TB - 1504	3.000
6	15	TB - 1506	4.100
12	15	TB - 1512	8.900
3	25	TB - 2503	3.600
4	25	TB - 2504	4.700
6	25	TB - 2506	5.900
12	25	TB - 2512	10.700

TERMINAL BLOCK TYPE IN



Pole	Ampere	Type	Price (Rp)
2	20	IN 12	7.400
3	20	IN 13	8.200
3	30	IN 20	11.600
3	50	IN 30	15.500
1	60	IN 411	9.900
1	90	IN 60	15.200
1	130	IN 100	37.400

TERMINAL BLOCK KRUSTIN

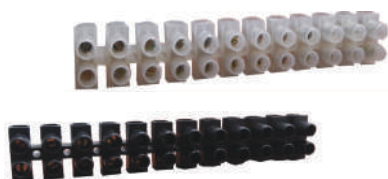

Voltage	Ampere / mm	Type	Price (Rp)
400V	4A/4mm	XLS-4A	6.700
400V	6A/6mm	XLS-6A	7.700
400V	10A/10mm	XLS-10A	10.700
400V	15A/12mm	XLS-15A	15.000
400V	20A/14mm	XLS-20A	16.600
400V	30A/16mm	XLS-30A	20.900
400V	60A/25mm	XLS-60A	34.900

TERMINAL BLOCK



TERMINAL BLOCK GROUNDING



Type	Terminal Size (mm)	Screw Size	Pole	Isolation Base Color	Price (Rp)
T001-0609/4	6 X 9	M4	4	Green	9.800
T001-0609/6		M4	6		11.600
T001-0609/8		M4	8		14.200
T001-0609/10		M4	10		15.500
T001-0609/12		M4	12		18.700
T001-0609/16		M4	16		22.800
T001-0812/4	8 X 12	M5	4	Green	16.300
T001-0812/6		M5	6		20.500
T001-0812/8		M5	8		23.900
T001-0812/10		M5	10		27.800
T001-0812/12		M5	12		31.500
T001-0812/16		M5	16		42.000
T150609	6 X 9	M4	132 (1M)	No Base	163.000
T150812	8 X 12	M5	132 (1M)		229.000
T151010	10 X 10	M5	132 (1M)		263.000

TERMINAL BLOCK KERAMIK



Pole	Ampere	Type	Price (Rp)
2	10	2W5H-10A	7.000
3	10	3W8H-10A	17.000
2	15	2W5H-15A	15.000
3	15	3W8H-15A	18.000
2	30	2W5H-30A	20.000
3	30	3W8H-30A	35.000

CONNECTOR CABLE



SPECIFICATION :

- * Fire Retardant Capability
- * Quick And Easy Installation

Description	Model	Capacity	Wire Size (mm)	Type	Price (Rp)		
Waterproof Connectors * Material : Polyamide PA66 & Copper * Rated voltage : 250-450VAC * Rate ampere : 16A * Working temperature : -40°C to 85°C * Protection degree : IP68		3P/16A	0.5 - 1.5	CNP20-3P	29.600		
		4P/16A	0.5 - 2.5	CNP25-4P	48.900		
		5P/16A		CNP25-5P	51.700		
		3P/16A	0.5 - 2.5	CNP25T-3P	60.000		
		4P/16A		CNP25T-4P	64.700		
		5P/16A		CNP25T-5P	69.300		
		3P/16A	0.3 - 2.5	CNP3742-3P	183.700		
		4P/16A		CNP3742-4P	202.300		
	Solar Panel Connectors * Material : Polycarbonate PC & Copper * Rated voltage : 1000-1500VDC * Locking system : Snap-in * Working temperature : -40°C to 105°C * Protection degree : IP67		30A/1000V	2.5 - 10	MC4-30A/1000V	11.900	
			50A/1000V	2.5 - 6	MC4-50A/1000V	24.400	
30A/1500V			2.5 - 10	MC4-30A/1500V	16.200		
50A/1500V			2.5 - 6	MC4-50A/1500V	31.000		
		50A/1500V	2.5 - 6	MC4-1-2T/1500V	96.900		
			30A/1000V	2.5 - 10	MC4-1-2Y/1000V	87.800	
Fast Connector * Material : Polyamide PA66 & Copper * Rated voltage : 450VAC * Rate ampere : 32A * Working temperature : -40°C to 105°C				3P/32A	0.5-2.5mm (NYAF) 0.5-4mm (NYA)	CMK-421-2	5.100
		4P/32A		CMK-421-3		7.000	
	5P/32A	CMK-421-4		8.400			
		6P/32A	CMK-422-4	9.700			
		8P/32A	CMK-422-6	11.600			
		10P/32A	CMK-422-8	13.900			
		2P/32A	CMK-412	2.300			
		3P/32A	CMK-413	2.600			
		4P/32A	CMK-414	3.600			
		5P/32A	CMK-415	4.000			
		8P/32A	CMK-418	8.100			
		2X2P/32A	CMK-422	5.900			
		3X3P/32A	CMK-423	8.300			
	Tab Wire Connectors		2P/32A	In: 1.5 - 2.5 Out : 0.5 - 2.5		CMK211-1	7.400
			3P/32A			CMK211-2	10.700
4P/32A			CMK212-2		12.900		
6P/32A			CMK212-4		21.300		

ISOLATOR



BAR HOLDER SILENDER TYPE ISOLATOR



Type	Diameter	High	SCREW	Price (Rp)
60 X 60	60	60	M12	35.600
40 X 60	40	60	M10	14.900
50 X 40	50	40	M10	13.800
40 X 40	40	40	M8	9.200
30 X 40	30	40	M6	6.900
30 X 30	30	30	M6	5.700

BAR HOLDER SQUARE TYPE ISOLATOR



Type	SCREW	Price (Rp)
T35X10	M10	15.000

ISOLATOR TYPE SM COLOR RED

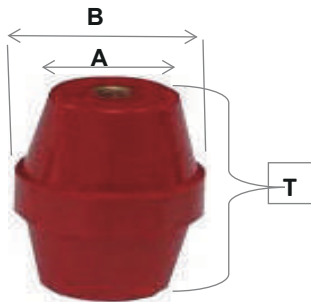

Type	Diameter (A/B) mm	High (T) mm	SCREW	Price (Rp)
SM 25-6	23 / 30	25	M6	4.000
SM 30-8/6	27 / 32	30	M8 / M6	6.000
SM 35-8	28 / 32	35	M8	6.800
SM 40-8	33 / 40	40	M8	7.600
SM 51-8	29 / 36	51	M8	8.000
SM 76-10	35 / 50	76	M10	22.500

BUSBAR SUPPORT ISOLATOR TANGGA



Description	Dimension (mm)	Busbar Size	Type	Price /Unit (Rp)
Step Busbar Isolator * Material : DMC/BMC * Temperature max. 30-120 °C * Strength : > 15N/M * Volatge : 660VAC	60 X 100	20mm	CT4-20	32.000
	130 X 132	30mm	CT4-30	61.000
	148 X 164	40mm	CT4-40	66.000
	200 X 212	50mm	CT4-50	123.000

INSULATOR



MEDIUM VOLTAGE INSULATOR



Description	Dimension (DxH) mm	Voltage	Type	Price /Unit (Rp)
Capacitive Insulator	90 X 210	24kV	ELC-24V	1.100.000
	60 X 130	12kV	ELC-12V	425.000
Indicator Display	for capacitive insulator		FIDELC	250.000
MV Insulator	70 X 90	7.5kV	EL-6M	130.000
	65 X 140	12kV	EL-12	189.000
	70 X 210	24kV	EL-24	340.000

BUSBAR SUPPORT



Description	Type	Pole	Busbar Size (mm)	Color	Price (Rp)
Busbar Jepit	FT-410	3P+N	1 X 10	Black	96.600
	FT-412	3P+N	1 X 12		
	EL-130	1P	4X10 or 3X5	White	28.400
	EL-270	3P	2X10 or 3X5	White	55.000
				Yellow	86.900
EL-410	3P+N	2X10 or 3X5	White	88.000	
			Yellow	115.000	
Nol Arde	FT-850	8 screw + 5 screw			44.000
	FTB-800	30 X 200mm			71.500
Busbar Jepit	FGCK - 1080	3P	3(10x80)	Brown	284.000
	FGCK - 10100		3(10x100)		292.000
	FGCK - 10120		3(10x120)		301.000

PANEL SUPPORT



BUSBAR PANEL

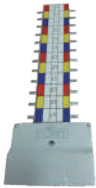

Description	Pole	Ampere (A)	Type	Price (Rp)
Busbar for MCB/MCCB	24	125A	FBP-24/125A	730.000
	36	250A	FBP-36/250A	1.250.000
	48	250A	FBP-48/250A	1.550.000

BUSBAR SISIR UNTUK MCB



Description	Size	Ampere (A)	Type	Price (Rp)
Untuk 1 phase	54 X 1 pole	63	FBM-1T	53.000
		100	FBM-1	80.000
Untuk 3 phase	18 X 3 pole	63	FBM-3T	143.000
		100	FBM-3	218.000

RELL UNTUK MCB



Description	Material	Type	Thickness (mm)	Price (Rp)
Untuk 1 fungsi, 1Meter	Alumunium	FTR01-09	0,9	19.300
		FTR01-11	1,1	25.300
Untuk 2 fungsi, 1Meter	Alumunium	FTR02-10	1	27.500
		FTR02-11	1,1	34.100
Untuk 1 fungsi, 1Meter	Iron / Besi	FTRB-11	1,1	18.400

STOPPER RAIL MCB



Description	Type	Price (Rp)
Untuk menahan ujung terminal block	GK-808-1	1.800
	TR-K	2.100
	CBR-F	2.000
	SUK-E	2.900
	E/CUK	2.400

FAN



AC- AXIAL BLOWER FAN



Description	Type	Model	Price (RP)
Size 120x120x25 (Size: 4") 220-240VAC, 50/60Hz (KOTAK)	XF1222ASH	Sleeve	86.700
	XF1222ABH	Ball Bearings	130.000
Size 120x120x38 (Size: 4") 220-240VAC, 50/60Hz (KOTAK)	XF1232ASH	Sleeve	86.700
	XF1232ABH	Ball Bearings	130.000
Size 172X150X51 (Size : 6") 220-240VAC, 50/60Hz (OVAL)	XF1552ASH	Sleeve	223.000
	XF1552ABH	Ball Bearings	248.000
Size 151X151X51 (Size: 6") 220-240VAC, 50/60Hz (KOTAK)	XF15051ASH	Sleeve	223.000
	XF15051ABH	Ball Bearings	248.000
> Size 172X172X51 (Size: 6") 220-240VAC, 50/60Hz (BULAT)	XF1752ASH	Sleeve	223.000
	XF1752ABH	Ball Bearings	248.000
> Size 200X200X60 (Size: 8") 220-240VAC, 50/60Hz (KOTAK)	XF20060MBL-2	Ball Bearings	458.000
Size 220X220X60 (Size : 8") 220-240VAC, 50/60Hz (BULAT)	XF22060HBL-1	Ball Bearings	458.000
Size 280X280X80 (Size : 10") 220-240VAC, 50/60Hz (KOTAK)	PF28080-2E / PF22580R	Ball Bearings	890.000

FAN ACCESSORY



Description	Model	For Fan Size	Price (RP)
Protected with Metal cover *Material Metal	200mm	200 X 200	23.600
	B-150mm	172 X 172	12.100
	120mm	120 X 120	7.200
Filter Plastic *Material plastic	148 X 148	120 X 120	76.700
	204 X 204	172 X 172	116.600
	255 X 255	200 X 200	133.800
	320 X 320	200 X 200	187.100

PANEL LOCK



	Model	Color	Type	Price (Rp)
	Push Lock/Open, without key	White	MS603	24.100
	Push Lock/Open, with key	White	MS603-3	25.300
	Push Lock/Open, with key	Black/White	AB-303	48.300
	Push Lock/Open, with key	White	AB-403	46.500
	Push lock/open with key, L = 150mm	Black	MS-490BL	82.100
	Push lock/open with key, L = 150mm	White (Doft)	MS-712	127.100
	Push lock/open with key, L = 150mm	White (mengkilap)	MS-712-B	161.800
	Push lock/open with key, L = 110mm	White (Doft)	MS-713	114.800
	Push lock/open with key, L = 110mm	White (mengkilap)	MS-713-B	124.400
	Push lock/open with key, L = 150mm	White (mengkilap)	MS-712-1	169.100
	Push lock/open with key, L = 110mm	White (mengkilap)	MS-713-1	132.800
	Handle + Lida kupu-kupu, L=120mm	White	MS-308-2	56.700
	Handle + Lida kupu-kupu, L=102mm	White	MS-308-3	49.500
	Handel Tanduk	White	MS-302-1/305-1	31.400
	Handle Tanduk	White	A19-1-1	66.400
	Handle + Lida, L=76mm	White	MS-303-1	31.600
	Handle + Lida, L=112mm	White	MS-301-1	32.900
	Handle	White	A45-1-1	60.400
	Handle	White	MS301-1-1	38.600
	Handle besar	White	MS306-2-1	120.800
	Bulat, D=23,5mm	White	MS-88A20	14.500
	Bulat, D=23,5mm	White	MS-402	12.100
	Bulat, D=28mm, kunci T	White / Black	MS-705	24.200
	Bulat, D=28mm, kunci T	White / Black	MS-705-3	24.200
	Bulat, D= 60mm	White	MS-172-1	114.800
	Bulat, D= 31,5mm	White	MS-172-2	73.700
	Anak Kunci T, panjang 68mm	White	T-705	8.600
	Handle U, panjang 100mm	White	U-100	17.800
	Protection Cover for MS-705	Black	FPC-22	3.000

HINGE PANEL BOX

ENGSEL PANEL BOX



Description	Type	Color	Price (Rp)
Panjang= 30mm	AB-03A	BLACK	12.600
Panjang= 40mm	AB-03B	BLACK	17.900
Panjang= 42mm	AB-04	BLACK	24.200
Panjang= 33mm	AB-206	BLACK	23.000
Panjang= 57mm	AB-12	BLACK	30.100
Panjang= 90mm	HL-048-9	WHITE	36.200
Panjang= 60mm	HL-048-6		21.000
P=50mm, Lebar=10mm	AB-204	WHITE	19.300
P=60mm, Lebar=10mm	AB-23	WHITE	24.200
P= 65mm, Lebar=10mm	AB-24	WHITE	25.200
P= 89mm, Lebar=14mm	AB-26	WHITE	44.400

EYE BOLTS



Size (mm)	Price (Rp)
12	17.900
16	27.500

HEAT SHRINK



HEAT SHRINK TUBING

Description :

- * Voltage : 1kV
- * Temperature : -55 °C to +125 °C
- * Color : Black, Red, Yellow, Green, Blue, yellow-green



Inner Diameter As Supplied (mm)	Wide/Lebar (mm)	Type	Qty / Roll (M)	Price / Roll (Rp)		
				R, Y, G, B	Hitam	Yello-Green
3	-	HS-3	100	-	219.000	-
4	-	HS-4	100	-	219.000	-
5	-	HS-5	100	-	231.000	435.000
6	-	HS-6	100	-	243.000	567.000
8	13	HS-8	100	335.000	300.000	604.000
9	15	HS-9	100	370.000	323.000	688.000
10	16	HS-10	100	416.000	323.000	749.000
12	20	HS-12	100	462.000	370.000	942.000
14	23	HS-14	100	497.000	439.000	1.208.000
16	25	HS-16	100	670.000	635.000	1.533.000
18	29	HS-18	100	869.000	833.000	1.715.000
20	33	HS-20	100	1.123.000	1.075.000	2.053.000
22	35	HS-22	100	1.208.000	1.183.000	2.354.000
25	40	HS-25	25	371.000	356.000	694.000
30	50	HS-30	25	432.000	411.000	905.000
40	65	HS-40	25	694.000	694.000	1.298.000
50	80	HS-50	25	875.000	845.000	1.750.000
60	95	HS-60	25	1.268.000	1.208.000	-
80	125	HS-80	25	1.449.000	1.389.000	-
100	160	HS-100	25	1.962.000	1.902.000	-
120	190	HS-120	25	2.264.000	2.204.000	-
150	235	HS-150	25	3.019.000	2.958.000	-

HEAT SHRINK BUSBAR 20KV

* COLOR / WARNA : MERAH BATA



Inner Diameter As Supplied (mm)	Wide/Lebar (mm)	Type	Qty / Roll (M)	Price / Roll (Rp)
30	50	HS-30KV	25	1.871.000
40	65	HS-40KV	25	2.375.000
50	80	HS-50KV	25	3.109.000
65	100	HS-65KV	25	3.682.000
75	115	HS-75KV	25	4.226.000
85	130	HS-85KV	25	4.769.000
100	160	HS-100KV	25	5.614.000
120	190	HS-120KV	25	6.907.000
150	235	HS-150KV	25	8.633.000
180	278	HS-180KV	25	11.682.000

FIBERGLASS SLEEVING

(SELONGSONG KABEL TAHAN PANAS)



FIBERGLASS SLEEVING

(SELONGSONG KABEL TAHAN PANAS)

Specification :

- * Material : PVC Fiberglass
- * Beakdown Voltage : 2.5kV
- * Temperature : +130 °C or at -25°C
- * Standard : IEC60684-1
- * Color green line, red line, blue line



Type	Diameter (mm)	Qty/Carton (M)	Price / Meter (Rp)
FBS-1	1	12000	820
FBS-2	2	6000	1.450
FBS-3	3	3500	1.860
FBS-4	4	2500	2.460
FBS-5	5	1700	3.530
FBS-6	6	1400	4.330
FBS-8	8	800	5.430
FBS-10	10	650	7.140
FBS-12	12	500	9.540
FBS-14	14	500	11.230
FBS-16	16	400	15.680
FBS-18	18	400	18.230
FBS-20	20	400	21.200

PANEL ACCESSORIES



PG NYLON CABLE GLAND

Color : Hitam dan Putih



Type	Cable Range (mm)	Price (Rp)
PG-7	3.5 - 6	1.500
PG-9	4 - 8	1.600
PG-11	5 - 10	1.700
PG-13.5	6 - 12	1.900
PG-16	10 - 14	2.400
PG-19	12 - 16	3.000
PG-21	13 - 18	4.500
PG-25	14 - 21	5.400
PG-29	18 - 25	6.300
PG-36	22 - 32	11.000
PG-42	30 - 38	16.500
PG-48	34 - 44	20.000

CG/MG NYLON CABLE GLAND

Color : Putih



Type	Cable Range (mm)	Price (Rp)
CG-16	5 - 10	4.000
CG-20	6 - 13	5.600
CG-25	10 - 18	7.700
CG-32	16 - 22	11.700
CG-40	20 - 27	15.400
CG-50	30 - 41	24.700
CG-60	40 - 53	35.100

BRASS CABLE GLAND

Description :

* Material : Nickel-Plated Brass

* IP 65



Type	Cable Range (mm)	Price (Rp)
BPG-11	5 - 10	17.500
BPG-13.5	6 - 12	19.300
BPG-16	10 - 14	20.600
BPG-19	12 - 16	29.000
BPG-21	13 - 18	37.500
BPG-25	14 - 21	48.300
BPG-29	18 - 25	70.000
BPG-36	22 - 32	105.000
BPG-42	30 - 38	166.600
BPG-48	34 - 44	211.400

Type	Cable Range (mm)	Price (Rp)
M18 x 1.5	10-5	18.400
M20 x 1.5	12-6	20.300
M22 x 1.5	10-14	21.600
M25 x 1.5	9-16	30.500
M28 x 1.5	18-13	39.400
M32 x 1.5	22-15	50.700
M37 x 1.5	25-18	73.500
M40 x 1.5	30-22	110.300
M50 x 1.5	38-32	174.900
M60 x 1.5	44-37	222.000

INDUSTRIAL CABLE GLAND



Specification :

- * Design Specification Standard : BS-6121 : Part I : 1989
- * Ingress Protection : IP66
- * Cable Type : Unarmoured
- * Material :
 - > For Gland : Brass
 - > For Sealing : Thermoplastic Elastomer

A1/A2 SERIES BRASS CABLE GLAND WITHOUT ARMOUR

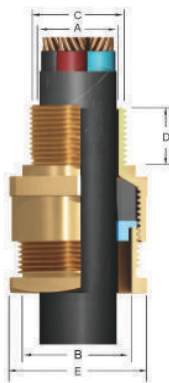

Size	Cable Dimension		Type	Price / Pcs (Rp)
	Min (mm)	Max (mm)		
20S	8,0	11,5	AAG0020SB	37.000
20L	11,0	13,5	AAG0020LB	41.000
25S	13,0	16,5	AAG0025SB	54.000
25L	13,0	19,5	AAG0025LB	57.000
32S	16,0	23,5	AAG0032SB	94.000
32L	19,0	25,5	AAG0032LB	96.000
40S	25,0	32,0	AAG0040SB	144.000
40L	27,0	33,0	AAG0040LB	154.000
50S	31,5	37,0	AAG0050SB	206.000
50L	36,5	43,0	AAG0050LB	230.000
63S	42,5	50,0	AAG0063SB	320.400
63L	49,5	55,0	AAG0063LB	331.200
75S	54,5	61,0	AAG0075SB	508.800
75L	60,5	67,0	AAG0075LB	518.400
90	65,0	78,0	AAG0090LB	672.000
100	75,0	88,0	AAG0100LB	1.142.400

KIT PACK FOR A1/A2

Size	Type	Price / Pcs (Rp)	Part	Type	Price / Pcs (Rp)	Part
20S	C-2025	9.200	 <p>PVC Shroud</p>	AET0020B	8.000	 <p>Earth Tags</p>
20L	20SCW			AET0025B	14.800	
25S	25SCM	11.500		AET0032B	16.000	
25L		AET0040B		20.200		
32S	32LCW	22.900		AET0050B	33.500	
32L		AET0063B		67.000		
40S	C40-53	34.500		AET0075B	80.500	
40L	CW32	45.900		AET0090B	335.000	
50S	40MM-L			63.200		
50L	C5068	91.900				
63S	C-7300	112.900				
63L	63SCW					
75S	63LCW					
75L	POLOS					
90	88L					

INDUSTRIAL CABLE GLAND



Specification :

- * Design Specification Standard : BS-6121 : Part I : 1989
- * Ingress Protection : IP66
- * Cable Type : Steel Wire Armour

* Material :

- > For Gland : Brass
- > For Sealing : Thermoplastic Elastomer

CW SERIES BRASS CABLE GLAND WITH ARMOUR

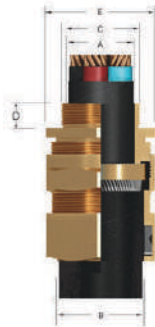

Size	Cable Dimension		Type	Price / Pcs (Rp)
	Min (mm)	Max (mm)		
20S	11,6	15,8	CWGM0020SB	58.000
20L	13,9	19,5	CWGM0020LB	69.000
25S	15,5	25,8	CWGM0025SB	86.000
25L	19,9	26,0	CWGM0025LB	102.000
32S	24,0	31,0	CWGM0032SB	182.500
32L	25,1	34,0	CWGM0032LB	190.400
40S	29,4	38,5	CWGM0040SB	212.000
40L	32,1	39,9	CWGM0040LB	230.000
50S	39,5	49,0	CWGM0050SB	308.000
50L	43,2	51,0	CWGM0050LB	432.000
63S	50,6	58,9	CWGM0063SB	611.500
63L	55,9	65,3	CWGM0063LB	661.200
75S	61,9	71,6	CWGM0075SB	988.800
75L	67,9	78,0	CWGM0075LB	1.056.000
90L	74,0	88,0	CWGM0090LB	1.446.000

KIT PACK FOR CW

Size	Type	Price / Pcs (Rp)	Part	Type	Price / Pcs (Rp)	Part
20S	C-2025	9.200	 <p>PVC Shroud</p>	AET0020B	8.000	 <p>Earth Tags</p>
20L	C-2030			AET0025B	14.800	
25S	25SCW	11.500		AET0032B	16.000	
25L	CW25L			AET0040B	20.200	
32S	32LCW	22.900		AET0050B	33.500	
32L				AET0063B	67.000	
40S	C40-53	34.500		AET0075B	80.500	
40L	CM40			AET0090B	335.000	
50S	50SCW	45.900				
50L	C5068					
63S	63SCW	63.200				
63L	63LCW					
75S	POLOS	91.900				
75L	POLOS					
90	88L	112.900				

LETTERING MACHINE



MARKING TUBE & LABELS MESIN



Description		Type	Price (Rp)
Marking Tube & Labels Mesin * Free 1 pita printing warna hitam * Free 1 label printing warna putih * Internal memori 1GB	Tanpa connection ke computer	S680E / S650E	10.290.000
	Dapat connection ke computer	S750E / S700E	12.978.000

SPARE PARTS LETTERING MACHINE



Description	Size	Color	Type	Price (Rp)
Ribbons / Pita printing Untuk type baru S680E/S750E	Panjang pita 80meter	Hitam	RS-100B	184.000
		Putih	RS-100W	278.000
		Merah	RS-100R	278.000
Ribbons / Pita printing Untuk type lama S650E/S700E	Panjang pita 80meter	Hitam	RS-80B	184.000
		Putih	RS-80W	278.000
		Merah	RS-80R	278.000
Label printing untuk semua model	Panjang label 8 meter, lebar 6mm	Putih	LS-06W	140.000
		Kuning	LS-06Y	
		Silver	LS-06S	
	Panjang label 8 meter, lebar 9mm	Putih	LS-09W	150.000
		Kuning	LS-09Y	
		Silver	LS-09S	
	Panjang label 8 meter, lebar 12mm	Putih	LS-12W	161.000
		Kuning	LS-12Y	
		Silver	LS-12S	
Knife / pisau printing machine			KS-01	351.000
Rubber/ karet roll printing machine			G-01	174.000

WIRING ACCESSORIES



CABLE MARKERS



Type	Cable Range (mm)	Markers	Price (Rp)
EC - 0	0.75 - 1.5	0 - 9 A - Z + / -	18.000
EC - 1	0.75 - 3.5		
EC - 2	3.5 - 8.0		
EC - 3	5.2 - 10.0		
FM-1	3.5 - 7		25.200

MARKER STRIP



Type	Size (mm)			Packing	Price (Rp)
	L	W	L in hole		
FMS-65	65	9	6	100pcs/bag	45.000
FMS-100	100	9	6		66.200
FMS-135	135	9	7		83.000

MARKER TUBE

COLOR : PUTIH



Type	Size	Qty/Roll (M)	Price / Roll (Rp)	
			KSS	FORT
MT-2.5	2,5mm	200	416.400	349.700
MT-3	3mm	200	501.800	415.800
MT-3.2	3,2mm	200	533.900	444.200
MT-3.5	3,5mm	200	587.300	486.200
MT-4	4mm	200	634.700	528.200
MT-4.5	4,5mm	200	749.900	624.800
MT-5	5mm	200	789.100	725.600
MT-5.5	5,5mm	100	510.200	462.000

SPIRAL WRAPPING BAND / KABEL SPIRAL

COLOR : PUTIH/HITAM



Type	Wrapping Range (mm)	Diameter (mm)	Price (Rp)	
			FORT	SUNLUX
KS-06	4 - 50	6	16.400	13.800
KS-08	6 - 60	8	22.100	18.400
KS-010	7.5 - 60	10	27.800	24.150
KS-012	9 - 65	12	35.400	27.600
KS-015	12 - 75	15	53.100	41.400
KS-019	15 - 100	19	74.600	60.950
KS-024	20 - 130	24	120.200	98.900

ELECTRIC TIPE ISOLATION



Description	Color	Qty pcs/box	Price / pcs (Rp)
0.13 X 3/4IN X 20M	Black, Red, Green,	250 pcs	9.200
0.15 X 3/4IN X 20M	Yellow, Blue	250pcs	10.500

NOTE : Fire Resistance

WIRING ACCESSORIES

NYLON CABEL TIES MERK



* WARNA : PUTIH & HITAM



Type	Size (mm)		Packing	Price (Rp)
	L	W		
FT-100S/CV-100S	100	2,5	100pcs/pack	5.300
FT-150S/CV-150S	150	3,6		14.300
FT-200M/CV-200M	200	2,5		15.400
FT-200S/CV-200S	200	3,6		18.200
FT-200L/CV-200L	200	4,8		23.100
FT-250S/CV-250S	250	3,6		23.100
FT-250L/CV-250L	250	4,8		31.900
FT-300S/CV-300S	300	3,6		27.900
FT-300L/CV-300L	300	4,8		36.300
FT-300T/CV-300T	300	7,6		68.200
FT-400L/CV-400L	400	4,8		49.500
FT-400T/CV-400T	400	7,6		77.000
FT-450L/CV-450L	450	4,8		91.300
FT-450T/CV-450T	450	7,6		100.000
FT-500T/CV-500T	500	7,6		108.000
FT-550T/CV-550T	550	9,0		198.000
- Cable Ties ini memenuhi standar Industri UL (USA)				
- Material : Nylon 66 (UL Recognized) UL Flammability 94V.2				

NYLON CABEL TIES MERK



* WARNA : PUTIH & HITAM



Type	Size (mm)		Packing	Price (Rp)
	L	W		
FSM 3 X 100	100	2,5	100pcs/pack	5.100
FSM 4 X 150	150	3,6		13.200
FSM 4 X 200	200	3,6		16.500
FSM 5 X 200	200	4,8		22.600
FSM 4 X 250	250	3,6		22.800
FSM 5 X 250	250	4,8		29.400
FSM 4 X 300	300	3,6		27.600
FSM 5 X 300	300	4,8		34.800

LABELING / MARKER TIE



Type	Size (mm)		Packing	Price (Rp)
	L	W		
MCV-100	100	2,5	100pcs/pack	29.700
MCV-110	110	2,5		33.000
MCV-200	200	3,6		41.800

WIRING ACCESSORIES



STAINLESS STEEL CABLE TIES



Type	Size (mm)		Packing	Price (Rp)
	L	W		
SS 4.6X150	150	4,6	100pcs/pack	115.000
SS 4,6X200	200	4,6		125.000
SS 4.6X300	300	4,6		152.000
SS 4.6X360	360	4,6		175.000
SS 4.6X400T	400	4,6		195.000
SS 8 X400L	400	7,9		295.000

STAINLESS STEEL 304 - PVC COATED



Type	Size (mm)		Packing	Price (Rp)
	L	W		
ML PVC-150M-304	150	4,6	100pcs/pack	317.000
ML PVC-200M-304	200	4,6		373.000
ML PVC-300M-304	300	4,6		466.000
ML PVC-400M-304	400	4,6		578.000

TY-RAP NYLON CABLE TIE

Description :

- * Material body : Nylon 66
- * Material Locking Brab : Stainless Steel Grade 304
- * Working Temperature : -40°C to 85°C
- * Flammability : UL94V-2
- * Halogen free and UV-resistant
- * Color : Black & White



Type	Size		Packing	Price (Rp)
	W	L		
TRC-400T	8,0	400	100pcs/pack	212.000

CABLE TIES REUSABLE / RELEASABLE



Type	Size		Color	Packing	Price (Rp)
	W	L			
CRL-200H	7,2	200	white & black	100pcs/pack	59.500
CRL-250H	7,2	250	white & black		73.800
CRL-300H	7,2	300	white & black		89.200

TIE MOUNTS



Type	Size (mm)		Warna tipe	Packing	Price (Rp)
	L	W			
HC-25	25	25	Hijau	100pcs/pack	45.800
HC-30	30	30	Hijau		62.200
FSM-25	25	25	Putih		39.500
FSM-30	30	30	Putih		46.300

WIRING ACCESSORIES

CERTIFICATE



CABLE TIES

TYPE	Panjang	Lebar	Warna	Qty / Karton	Harga / pack (Rp)
FE-100M (1,000)	100	2,5	Natural, Hitam	55 pack	65.100
FE-100MC	100	2,5	Natural, Hitam	500 pack	8.200
FE-150MC	150	2,5	Natural, Hitam	400 pack	15.300
FE-150IC	150	3,6	Natural, Hitam	220 pack	18.500
FE-200IC	200	3,6	Natural, Hitam	170 pack	23.600
FE-250IC	250	3,6	Natural, Hitam	150 pack	31.900
FE-300IC	300	3,6	Natural, Hitam	140 pack	39.300
FE-200STC	200	4,8	Natural, Hitam	120 pack	30.700
FE-250STC	250	4,8	Natural, Hitam	100 pack	37.600
FE-300STC	300	4,8	Natural, Hitam	90 pack	46.200
FE-370 ST	370	4,8	Natural, Hitam	80 pack	54.800
FE-300HD	300	7,6	Natural, Hitam	50 pack	90.000
FE-370HD	370	7,6	Natural, Hitam	40 pack	102.500
FE-450HD-S	450	7,6	Natural, Hitam	25 pack	190.700
FE-530HD	530	9	Natural, Hitam	20 pack	233.000
FL-100MC	100	2,5	Red, Blue, Green, Yellow	550 pack	8.700
FL-150IC	150	3,6	Red, Blue, Green, Yellow	300 pack	24.700
FL-200IC	200	3,6	Red, Blue, Green, Yellow	220 pack	33.600
FL-250STC	250	4,8	Red, Blue, Green, Yellow	120 pack	52.200

LABEL CABLE TIES

TYPE	Panjang	Lebar	Warna	Qty / Karton	Harga / pack (Rp)
GTK-110M	110	2,5	Natural	280 pack	50.400

CABLE TIES UV RESISTANCE

TYPE	Panjang	Lebar	Warna	Qty / Karton	Harga / pack (Rp)
GT-150STC - UV	150	4,8	Hitam	- pack	57.000
GT-250STC - UV	250	4,8	Hitam	- pack	71.900
GT-370HD - UV	370	7,6	Hitam	- pack	211.600

WIRING ACCESSORIES



LASDOP PRESS



Type	Size (mm)	Size AWG (mm)	Qty/pack	Price/pack (Rp)
XLS-3	1,25	22 - 16	100	24.900
XLS-4	2	16 - 14	100	27.400
XLS-5	5,5	12 - 10	100	36.100
XLS-6	8	8	100	41.000
XLS-7	10	8 - 6	100	76.500
XLS-8	13	6	100	142.900

LASDOP / SCREW ON WIRE CONNECTORS



Type	Cable Size (mm)	Color	Qty/pack	Price/pack (Rp)
XLS-P71	0.5 - 1	Grey	100	26.100
XLS-P72	1 - 1,5	Blue	100	32.000
XLS-P73	1,5 - 2,5	Orange	100	39.600
XLS-P74	2,5 - 4	Yellow	100	45.000

LASDOP / DOUBLE WINGS SCREW ON WIRE CONNECTORS



Type	Cable Size (mm)	Color	Qty/pack	Price/pack (Rp)
CJS-SP1	4 - 8	yellow	100	91.400
CJS-SP2	6 - 12	red	100	104.500

CABLE CLIP / KLAM KABEL



Size (mm)	Type	Qty pcs/bag	Price/pack (Rp)
4	FCC-4	100	7.100
5	FCC-5	100	7.800
6	FCC-6	100	8.600
7	FCC-7	100	10.100
8	FCC-8	100	11.000
9	FCC-9	100	13.100
10	FCC-10	100	14.300
12	FCC-12	50	8.900
14	FCC-14	50	12.900
16	FCC-16	50	15.400
18	FCC-18	50	21.400
20	FCC-20	50	25.000
22	FCC-22	50	30.900

CABLE LUGS

Scun Cable (Type SC)

* Plating : warna putih dove

* Bahan : Tembaga / Copper



Type	Cable Size (mm)	Diameter (mm)	Price /pcs (Rp)
SC-2.5	2,5	5	540
SC-4	4	5	780
SC-6	6	5	920
		6	
		8	
SC-10	10	6	980
		8	
SC-16	16	6	1.650
		8	
		10	
SC- 25	25	6	2.420
		8	
		10	
SC-35	35	6	4.300
		8	4.300
		10	4.000
SC-50	50	8	6.470
		10	6.100
		12	5.900
SC-70	70	8	11.000
		10	11.000
		12	10.500
SC-95	95	8	16.500
		10	16.000
		12	15.500
SC-120	120	10	22.500
		12	21.600
		16	21.600
SC-150	150	10	29.000
		12	28.500
		16	28.500
SC-185	185	16	36.900
SC-240	240	16	50.000
SC-300	300	16	79.200
SC-400	400	16	142.000
SC-500	500	16	178.900
SC-630	630	20	266.200



Heavy Duty Scun Cable (Type CE)

* Kualitas Standar UL dan TUV

* Plating : warna putih mengkilap

* Bahan : Tembaga / Copper (Tebal)

Type	Cable Size (mm)	Diameter (mm)	Price /pcs (Rp)
CE- 25	25	8	4.300
CE-35	35	8	7.200
CE-50	50	10	10.800
CE-70	70	10	15.800
CE-95	95	12	23.000
CE-120	120	12	37.400
CE-150	150	12	51.400
CE-185	185	16	59.900
CE-240	240	16	100.100
CE-300	300	16	137.200
CE-400	400	16	185.200
CE-500	500	16	254.900
CE-630	630	20	465.500



CE type



SC type

CABLE LUGS



SCUN BIMETAL AL - CU (DTL-1 & DTL-2)

* Material : Alumunium - Tembaga



DTL-2



DTL-1

Type	Cable Size (mm)	Bolt Size (mm)	Price /pcs (Rp)
DTL-2-35	35	8	26.500
DTL-2-50	50	10	32.800
DTL-2-70	70	10 / 12	32.800
DTL-2-95	95	13	32.800
DTL-2-120	120	12	63.000
DTL-2-150	150	13	63.000
DTL-2-185	185	12	92.000
DTL-2-240	240	13	92.000
DTL-2-300	300	12	114.700
DTL-2-400	400	12	186.500
<hr/>			
DTL1-35	35	10	6.160
DTL1-50	50	10	9.020
DTL1-70	70	12	10.010
DTL1-95	95	12	15.730
DTL1-120	120	14	18.700
DTL1-150	150	14	23.100
DTL1-185	185	14	30.800
DTL1-240	240	16	39.380
DTL1-300	300	21	65.780

SCUN ALUMUNIMUM (TYPE DL)

* Material : Aluminium



Type	Cable Size (mm)	Bolt Size (mm)	Price /pcs (Rp)
DL-35	35	8	3.300
DL-50	50	10	4.680
DL-70	70	12	6.480
DL-95	95	12	8.880
DL-120	120	14	11.160
DL-150	150	14	13.920
DL-185	185	16	17.400
DL-240	240	16	24.000
DL-300	300	16	40.560



DL

SCUN COPPER BELAH (TYPE OT)

* Plating : warna kuning mengkilap

* Material : Copper / Tembaga



Type	Size	Price /pcs (Rp)
OT-10A	10A	700
OT-20A	20A	1.000
OT-30A	30A	1.500
OT-40A	40A	2.000
OT-50A	50A	2.200
OT-60A	60A	2.800
OT-80A	80A	3.700
OT-100A	100A	4.500
OT-150A	150A	5.500
OT-200A	200A	7.700
OT-250A	250A	10.400
OT-300A	300A	12.900



SCUN COPPER PANJANG (TYPE DTG)

* Plating : warna kuning mengkilap

* Material : Copper / Tembaga

Type	Cable Size (mm)	Bolt Size (mm)	Price /pcs (Rp)
DTG-35	35	8	8.600
DTG-50	50	10	11.500
DTG-70	70	10	18.500
DTG-95	95	12	23.800
DTG-120	120	12	40.900
DTG-150	150	12	45.300
DTG-185	185	16	66.700
DTG-240	240	16	79.200
DTG-300	300	16	132.000



VERBENDING / CONNECTORS CABLE



CONNECTOR (TYPE L)

- * Plating : warna putih dove
- * Material : Copper / Tembaga



Cable Size (mm)	Type	Price /pcs (Rp)
4	L - 4	900
6	L - 6	1.300
10	L - 10	1.400
16	L - 16	2.200
25	L - 25	3.300
35	L - 35	4.900
50	L - 50	6.700
70	L - 70	10.800
95	L - 95	14.100
120	L - 120	21.100
150	L - 150	25.000
185	L - 185	34.900
240	L - 240	51.800
300	L - 300	74.800

CONNECTOR PANJANG (TYPE GT)

- * Plating : warna kuning mengkilap
- * Material : Copper / Tembaga



Cable Size (mm)	Type	Price /pcs (Rp)
16	GT-16	5.300
25	GT-25	7.800
35	GT-35	10.500
50	GT-50	14.100
70	GT-70	21.100
95	GT-95	28.200
120	GT-120	42.900
150	GT-150	51.800
185	GT-185	73.400
240	GT-240	96.800
300	GT-300	158.700

CONNECTOR AL - CU (TYPE GTL)

- * Plating : warna putih dove
- * Material : Aluminium - Tembaga



Cable Size AL - CU mm	Type	Price /pcs (Rp)
16 - 10	GTL-16	11.900
25 - 16	GTL-25	15.400
35 - 25	GTL-35	20.100
50 - 35	GTL-50	27.100
70 - 50	GTL-70	34.200
70 - 70	GTL-70-2	40.700
95 - 70	GTL-95	43.400
120 - 95	GTL-120	62.200
150 - 120	GTL-150	73.500
185 - 150	GTL-185	84.000
240 - 185	GTL-240	102.100
300 - 240	GTL-300	171.300

CONNECTOR (TYPE GL)

- * Plating : warna putih dove
- * Bahan : Aluminium



Cable Size (mm)	Type	Price /pcs (Rp)
35	GL-35	3.800
50	GL-50	5.800
70	GL-70	7.400
95	GL-95	9.500
120	GL-120	12.000
150	GL-150	13.900
185	GL-185	16.300
240	GL-240	21.400
300	GL-300	35.000

SKUN KABEL



SKUN TYPE Y

Isolasi - Warna : Merah, Kuning, Hitam & Biru



Type	For Cable (mm)	Qty / pack	Price/Pack (Rp)
SVS - 1.25 - 3.5	0.25 - 1.5	100pcs	23.100
SVS - 1.25 - 4			
SVS - 2 - 3.5	1.25 - 2.5	100pcs	26.300
SVS - 2 - 4			
SVL - 3.5 - 4	2.5 - 4	100pcs	53.100
SVL - 3.5 - 5			53.100
SVL - 3.5 - 6			60.400
SVL - 5.5 - 4	4 - 6	100pcs	72.500
SVL - 5.5 - 5			72.500
SVL - 5.5 - 6			90.600

SKUN TYPE RING O

Isolasi - Warna : Merah, Kuning, Hitam & Biru



Type	For Cable (mm)	Qty / pack	Price/Pack (Rp)
RVS - 1.25 - 3.5	0.25 - 1.5	100pcs	27.800
RVS - 1.25 - 4			27.800
RVS - 1.25 - 5			31.400
RV - 1.25 - 6			48.300
RVS - 2 - 3.5	1.25 - 2.5	100pcs	32.600
RVS - 2 - 4			32.600
RVS - 2 - 5			39.800
RV - 2 - 6			51.900
RV - 2 - 8			59.200
RVS - 3.5 - 4	2.5 - 4	100pcs	56.800
RVS - 3.5 - 5			56.800
RVS - 3.5 - 6			76.100
RVS - 5.5 - 4	4 - 6	100pcs	86.900
RVS - 5.5 - 5			89.400
RV - 5.5 - 6			91.800
RV - 5.5 - 8			108.700

SKUN KABEL



SKUN TYPE Y

Non Isolated / Tanpa Isolasi



Type	For Cable (mm)	Qty / pack	Price/Pack (Rp)
SNBS - 1.25 - 3.5	0.25 - 1.5	100pcs	23.900
SNBS - 1.25 - 4			
SNBS - 2 - 3.5	1.25 - 2.5	100pcs	28.600
SNBS - 2 - 4			
SNB - 3.5 - 5	2.5 - 4	100pcs	55.000
SNB - 3.5 - 6			69.500
SNB - 5.5 - 4	4 - 6	100pcs	71.900
SNB - 5.5 - 5			75.500
SNB - 5.5 - 6			90.000

SKUN TYPE RING O

Non Isolated / Tanpa Isolasi



Type	For Cable (mm)	Qty / pack	Price/Pack (Rp)
RNBS - 1.25 - 3.5	0.25 - 1.5	100pcs	27.200
RNBS - 1.25 - 4			27.200
RNBS - 1.25 - 5			31.000
RNB - 1.25 - 6			47.700
RNBS - 2 - 4	1.25 - 2.5	100pcs	32.200
RNBS - 2 - 5			39.400
RNB - 2 - 6			51.300
RNB - 2 - 8			58.600
RNBS - 3.5 - 4	2.5 - 4	100pcs	56.100
RNBS - 3.5 - 5			56.100
RNBS - 3.5 - 6			75.500
RNBS - 5.5 - 4	4 - 6	100pcs	86.300
RNBS - 5.5 - 5			88.700
RNB - 5.5 - 6			91.200
RNB - 5.5 - 8			108.100

SKUN KABEL



INSULATED FEMALE DISCONNECTOR



Type	For Cable (mm)	Warna	Qty / pack	Price/Pack (Rp)
FDD - 1.25 - 250	0.25 - 1.5	Merah	100pcs	31.800
FDD - 2 - 250	1.5 - 2.5	Biru		34.200
FDD - 5.5 - 250	4 - 6	Kuning		48.500

INSULATED MALE DISCONNECTOR



Type	For Cable (mm)	Warna	Qty / pack	Price/Pack (Rp)
MDD - 1.25 - 250	0.25 - 1.5	Merah	100pcs	31.800
MDD - 2 - 250	1.5 - 2.5	Biru		34.200
MDD - 5.5 - 250	4 - 6	Kuning		48.500

INSULATED MALE BULLET DISCONNECTOR



Type	For Cable (mm)	Warna	Qty / pack	Price/Pack (Rp)
MPD - 1.25 - 156	0.25 - 1.5	Merah	100pcs	47.200
MPD - 2 - 156	1.5 - 2.5	Biru		48.500
MPD - 5.5 - 156	4 - 6	Kuning		70.800

INSULATED FEMALE BULLET DISCONNECTOR



Type	For Cable (mm)	Warna	Qty / pack	Price/Pack (Rp)
FRD - 1.25 - 156	0.25 - 1.5	Merah	100pcs	47.200
FRD - 2 - 156	1.5 - 2.5	Biru		48.500
FRD - 5.5 - 156	4 - 6	Kuning		70.800

FULL INSULATED DISCONNECTOR



Type	For Cable (mm)	Warna	Qty / pack	Price/Pack (Rp)
FDFD - 1.25 - 250	0.25 - 1.5	Merah	100pcs	55.300
FDFD - 2 - 250	1.5 - 2.5	Biru		59.600
FDFD - 5.5 - 250	4 - 6	Kuning		78.300

SKUN KABEL



INSULATED VINYL BUTT CONNECTOR



Type	For Cable (mm)	Warna	Qty / pack	Price/Pack (Rp)
BV - 1.25	0.25 - 1.5	Merah /Biru	100pcs	44.100
BV - 2	1.5 - 2.5	Biru		52.000
BV - 5.5	4 - 6	Kuning		83.400
BV - 8	6 - 8	Merah		265.700

INSULATED PIN TERMINAL



Type	For Cable (mm)	Warna	Qty / pack	Price/Pack (Rp)
PTV - 1.25 - 12	0.25 - 1.5	M, K, H, B	100pcs	31.400
PTV - 2 - 12	1.5 - 2.5	B, K, H, M		32.600
PTV - 5.5 - 12	4 - 6	K, M, H, B		76.100

INSULATED BLADE TERMINAL / PLATE TERMINAL



Type	For Cable (mm)	Warna	Qty / pack	Price/Pack (Rp)
DBV - 1.25 - 18	0.25 - 1.5	Merah	100pcs	39.800
DBV - 2 - 18	1.5 - 2.5	Biru		41.100
DBV - 5.5 - 18	4 - 6	Kuning		84.900

TERMINAL VINYL INSULATION

Warna : Merah, Kuning, Hitam, Biru & Hijau



Type	Diameter (mm)	For Cable Lugs	Qty / Pack (pcs)	Price/Pack (Rp)
V - 1.25	3,1	SC-2.5	100	5.000
V - 2	3,7	SC-4		6.200
V - 3.5	4,1	SC-6		9.700
V - 5.5	5,2	SC-10		10.200
V - 8	6,2	SC-16		14.900
V - 14	8,0	SC-25		21.100
V - 22	9,5	SC-35		29.700
V - 38	11,8	SC-50		47.100
V - 60	13,5	SC-70		62.000
V - 80	16,0	SC-95	97.900	
V - 100	18,0	SC-120	126.400	
V - 125	20,0	SC-150	50	86.700
V - 150	22,0	SC-185		102.800
V - 200	24,0	SC-240	25	68.100
V - 250	26,5	SC-300		88.600
V - 325	29,0	SC-400		101.600
V - 400	36,0	SC-500		157.400
V - 500	40,0	SC-630		174.700
V - 630	44,0	SC-630		204.400

SKUN KABEL



INSULATED CORD END TERMINAL / FERRULES



Type	For Cable (mm)	Color	Qty / pack (pcs)	Price/Pack (Rp)
E 0508	0,5	white	100pcs	9.900
E 7508	0,75	blue		9.900
E 1008	1	red		9.900
E 1508	1,5	black		10.900
E 2508	2,5	grey		15.100
E 4010	4	orange		21.300
E 6012	6	green		33.000
E 1012	10	brown		36.000
E 1612	16	ivory		49.400
E 1618	16	ivory		68.000
E 2516	25	black		70.700
E 3516	35	beige		92.600
E 5020	50	olive		163.300
E 7025	70	black		433.700

NON INSULATED CORD END TERMINAL / FERRULES



Type	For Cable (mm)	Color	Qty / pack (pcs)	Price/Pack (Rp)
EN 7508	0,75	non insulated	100pcs	8.900
EN 1008	1	non insulated		8.900
EN 1508	1,5	non insulated		9.400
EN 2508	2,5	non insulated		13.900
EN 4010	4	non insulated		19.800
EN 6012	6	non insulated		30.500
EN 1012	10	non insulated		34.700
EN 1612	16	non insulated		41.000
EN 2516	25	non insulated		65.100
EN 3516	35	non insulated		79.800
EN 5020	50	non insulated		149.600

TWIN INSULATED CORD END TERMINAL / FERRULES UNTUK 2 KABEL



Type	For Cable (mm)	Color	Qty / pack (pcs)	Price/Pack (Rp)
TE 0508	2 X 0.5	white	100pcs	17.300
TE 7508	2 X 0.75	blue		18.100
TE 1008	2 X 1	red		19.300
TE 1508	2 X 1.5	black		22.900
TE 2510	2 X 2.5	grey		32.600
TE 4012	2 X 4	orange		48.300
TE 6014	2 X 6	green		56.700
TE 1014	2 X 10	brown		83.300
TE 1614	2 X 16	ivory		102.600

ELECTRICAL TOOLS



CRIMPING TOOLS



Type	For Terminal	Capacity	Price (Rp)
LX-03C		0,5 - 6mm	164.000
LX-101		1,0 - 10mm	164.000
LX-03B		0,5 - 6mm	164.000
LX-16		1,25 - 16mm	210.000
LX-38		5,5 - 38mm	350.000
LX-06WF		0,5 - 6mm	178.000
LXC8 6-4		0,25 - 6mm	320.000

CRIMPING TOOLS FOR TERMINAL SC (CABLE LUGS)



Type	For Terminal	Capacity	Price (Rp)
HX-240B	Terminal SC / Cable Lugs	70 - 240mm	1.044.800

HYDRAULIC CRIMPING TOOLS



Type	For Terminal	Capacity	Price (Rp)
YQX-70	Terminal SC / Cable Lugs	4 - 70mm	771.800
YQX-300A		16 - 300mm	1.050.000

CABLE CUTTER



Type	For Cable	Price (Rp)
LK-38A	max. 35mm	89.800
LX-500	max. 500mm	961.100

AUTOMATIC WIRE STRIPPERS (PENGUPAS KABEL OTOMATIS)



Type	For Cable	Price (Rp)
LX-700A	0,25 - 2,0mm	144.800
LX-700B	1,0 - 3,2mm	144.800
LX-700F	0,25 - 2,5mm	100.800

BATTERY TOOLS



Description	Type	Price (Rp)
Battery Crimping Tools * Crimping range : 16 - 300mm * Capacity : 4.0Ah /18V * Charging time : 2 hours * Crimp/charging : 300 times crimping * Include : 2 battery	JEZA-300A	16.652.000
Battery Crimping & Cutting Tools * 2in1 tools : for Crimping & Cutting * Crimping range : 16 - 400mm * Cutting cable range max 85mm * Capacity : 4.0Ah /18V * Charging time : 2 hours * Crimp/charging : 120 times crimping * Include : 2 battery	JEZ-400/85C	24.978.000

Price List 2024

COPPER BUSBAR TOOLS



Description	Type	Price (Rp)
Punch Tool (Pelubang Busbar) * Untuk Tebal Busbar Tembaga max : 12mm * Output : 35 Ton * Dies Silinder (bulat) : 3/8"(10,5mm), 1/2"(13.8mm), 5/8"(17,5mm), 3/4"(20.5mm)	CH-70	5.700.000
Bending Tool (Penekuk Busbar Tembaga) * Untuk Tebal Busbar Tembaga max : 12mm * Lebar Busbar Copper : 200mm * Output : 20ton	CB-200A	5.000.000
Cutting Tool (Pemotong Busbar Tembaga) * Untuk Tebal Busbar Tembaga max : 12mm * Lebar Busbar Copper : 200mm * Output : 20ton	CWC-200	5.500.000
Hydraulic Crimping Head * Untuk Cable Ukuran 150 - 630mm * Crimping Dies : 150, 185, 240, 300, 400, 500, 630mm * Output : 30 Ton	FYQ-630A	8.600.000
Hydraulic Pump (Manual Pompa Hydraulic) * Untuk Pompa Punch, Cutting, Crimping dan Bending Tool * Max. Output Pressure : Low pressure 2Mpa, High pressure 70MPa * Dimension : 510 X 150 X 200mm	CP-700B	3.300.000
Electric Pump (Pompa Electric) * Power 0.4kW, 220VAC / 50Hz * Max. Output Pressure : Low pressure 2Mpa, High pressure 70MPa * Dimension : 230X155X306 * Untuk Pompa Punch, Cutting, Crimping dan Bending Tool	TEP-700B	13.500.000
Punch Driver Kits (Pelubang Plat Panel Listrik) * Untuk Tebal Plat Panel max : 3.5mm * Output : 15 Ton * Dies Silinder (Bulat) : 16mm, 22mm, 30mm * Dies Square (Persegi) : 46 X 46 (48X48)mm, 68 X 68 (72X72)mm, 92 X 92 (96X96)mm * Dies Retangular (Persegi Pajang) : 46 X 92 (48X96)mm	SYK-15	12.100.000
Multifunction Tools Including : * Bending tools (penekuk busbar) * Punch Tool (pelubang busbar) * Cutting tools (pemotong busbar)	DHY-200	42.000.000
Dies / Moulding for CH-70	3/8" (10.5mm)	400.000
	1/2"(13.8mm)	
	5/8"(17.5mm)	
	3/4" (20.5mm)	
Dies / Moulding for SYK-15	46X46 (48X48)	1.900.000
	68X68 (72X72)	3.100.000
	92X92 (96X96)	3.800.000
	46X92 (48X96)	3.800.000
	16mm	200.000
	22mm	250.000
	30mm	350.000

EARTHING & LIGHTNING PRODUCT



Description	Size	Type	Price (Rp)
Air Termination * Material : Stainless rod & Brass holder (copper plating)	14 x 500mm	FACT514	273.000
Earhting Rod / Grouding Rod * Material : Steel copper tin plating	5/8 inch x 2.5meter	FERT1425	143.000
	5/8 inch x 2meter	FERT1420	108.700
	5/8 inch x 1.5meter	FERT1415	81.600
	3/4 inch x 2meter	FERT1720	181.000
Connector Rod * Material : Brass copper plating	5/8 inch	FCR-14	48.600
	3/4 inch	FCR-17	63.600
Clamp Grounding Cable BC * Material : Brass	14mm	FRCC14BCU	18.900
	18mm	FRCC16BCU	24.300
Clamp Cable / Kuku Macan * Material : Brass	10 - 50mm	FTC10-50	25.100
	16 - 95mm	FTC16-95	45.500
	25 - 150mm	FTC25-150	110.600
U-Bolt Clamp Cable * Material : Copper & Brass	25 - 120mm (1way)	FURCC1H	80.700
	25 - 120mm (2way)	FURCC2H	80.700
	25 - 120mm (3way)	FURCC3H	87.200
U-Bolt GUV Clamp Cable / T type * Material : Copper & Brass	50 - 185mm	FTRCC1H	169.900
U-Bolt Busbar Flat Clamp * Material : Copper & Brass	3 x 25mm	FUC25	122.000
	3 x 32mm	FUC32	180.000
Tap Clamp Plat AL/CU * Material : Brass	3 x 25mm	FCDC253	36.000
		FCSC253	77.500
C - Clamp CU * Material : Copper/Tembaga	14 - 20 mm ²	CCT-14	7.200
	21 - 26 mm ²	CCT-26	9.700
	27 - 44 mm ²	CCT-44	18.700
	45 - 60 mm ²	CCT-60	20.500
	61 - 76 mm ²	CCT-76	29.500
	77 - 96 mm ²	CCT-98	34.800
	99 - 122 mm ²	CCT-122	44.700
	123 - 154 mm ²	CCT-154	56.300
	155 - 190 mm ²	CCT-190	67.800

EXPLOSION - PROOF PRODUCT



EXPLOSION-PROOF BOX

* Product Explosion proof Certification :

Specification :

* Material : Aluminium alloy

* Explosion-proof mark : Ex eb II C T6 Gb ; Ex tb IIIC T80°Db ; Ex db IIB T4 Gb ; Ex db eb IIC T4 Gb



Description	Size (mm)			Type	Price (Rp)
	Width	Height	Depth		
Explosion-Proof Junction Box * Material : Aluminium alloy * Base plate : Resin base * Ingress protection : IP66 * Explosion-proof mark : Ex eb II C T6 Gb ; Ex tb III C T80 °C Db	135	135	97	BXJ-1313-9	1.190.000
	135	200	100	BXJ-1320-10	1.421.000
	140	210	120	BXJ-1421-12	2.149.000
	200	200	100	BXJ-2020-10	1.818.000
	200	300	150	BXJ-2030-15	3.190.000



Explosion-Proof Distribution Box * Material : Aluminium alloy * Base plate : Resin base * Ingress protection : IP54 * Explosion-proof mark : Ex db II B T4 Gb	200	250	170	BXJ-60-2025-17	10.596.000
	200	300	150	BXJ-60-2030-15	3.339.000
	250	300	160	BXJ-60-2530-16	12.464.000
	300	300	150	BXJ-60-3030-15	4.397.000
	300	400	190	BXJ-60-3040-19	5.835.000
	400	500	200	BXJ-60-4050-20	10.447.000
	500	600	200	BXJ-60-5060-20	15.357.000
	560	720	325	BXJ-60-5672-32	60.270.000



Explosion-Proof Power Distribution Box * Material : Aluminium alloy * Base plate : Resin base * Ingress protection : IP65 * Explosion-proof mark : Ex db eb II C T4 Gb (* Khusus digunakan untuk area gas : hydrogen, acetylene, carbon disulfide)	300	300	160	BXM(D)-3030-16	8.656.000
	400	400	240	BXM(D)-4040-24	47.166.000
	600	600	200	BXM(D)-6060-20	33.605.000



Description	Size (mm)			Type	Price (Rp)
	Hole	Width	Depth		
Explosion-Proof Control Box * Material : Aluminium alloy * Ingress protection : IP66 * Explosion-proof mark : Ex db eb II C T6 Gb ; Ex tb III C T80 Db	30	76	78	LA53-301 (1 hole)	384.600
				LA53-302 (2 hole)	559.500
				LA53-303 (3 hole)	621.500
				LA53-304 (4 hole)	717.600



Description	Size (mm)			Type	Price (Rp)
	Pipe thread	Diameter	Height		
Explosion-Proof Junction Box * Material : Aluminium alloy * Base plate : Resin base * Ingress protection : IP66 * Explosion-proof mark : Ex db	G-3/4	95	59	AH-G3/4B (2 way-through)	322.500
				AH-G3/4E (2 way-angle)	322.500
				AH-G3/4C (3way)	322.500
				AH-G3/4D (4 way)	322.500

EXPLOSION - PROOF PRODUCT



EXPLOSION-PROOF COMMAND SWITCH

Specification :

- * Material : Polyamide PA66
- * Ingress protection : IP66
- * Explosion protection : Exd IIC Gb

* Product Explosion proof Certification :



Description	Diameter (mm)	Color	Type	Price (Rp)
Pilot Lamp LED * Rated voltage : 220-380VAC/50Hz	30	Red	YJY8030-DR02	152.000
		Green	YJY8030-DG02	
		Yellow	YJY8030-DY02	
		White	YJY8030-DW02	
		Blue	YJY8030-DB02	
Pilot Lamp LED * Rated voltage : 24-36VAC/DC	30	Red	YJY8030-DR01	162.000
		Green	YJY8030-DG01	
		Yellow	YJY8030-DY01	
		White	YJY8030-DW01	
		Blue	YJY8030-DB01	
Push Button * Flush head, spring return * 1NO 1NC	30	Red	YJY8097-AR11F	290.000
		Green	YJY8097-AG11F	
		Yellow	YJY8097-AY11F	
		Black	YJY8097-AH11F	
		Blue	YJY8097-AB11F	
Push Button Lamp * Flush head, spring return * 1NO 1NC * Rated voltage : 220-380VAC/50Hz	30	Red	YJY8097-ADR0211F	687.000
		Green	YJY8097-ADG0211F	
		Yellow	YJY8097-ADY0211F	
Selector Switch * Stay put, 2Position (1NO 1NC)	30	Black	YJY8097-CXSB112S	580.000
		Black	YJY8097-CXSB203S	
* Stay put, 3Position (2NO)				
Emergency Push Button * Mushroom head * Push lock - Turn to release * Contact 1NO 1NC	30	Red	YJY8097-ZTR11S	615.000

EXPLOSION - PROOF PRODUCT

EXPLOSION-PROOF BRASS CABLE GLAND

Specification :

- * Material : Brass, Nickel plated/SS304/SS316L
- * Ingress protection : IP66
- * Explosion protection : Exd IIC Gb
- * Clamping type : Armored cable



* Product Explosion proof Certification :



NPT - Armored Cable Gland



G / M - Armored Cable Gland



PVC Shroud



Earth Tags



Type	Price (Rp)
JXBTL-NPT1/2	225.000
JXBTL-NPT3/4	298.000
JXBTL-NPT1	510.000
JXBTL-NPT1-1/4	739.000
JXBTL-NPT1-1/2	1.125.000
JXBTL-NPT2	1.687.000
JXBTL-NPT2-1/2	3.052.000
JXBTL-NPT3	5.460.000
JXBTL-NPT4	9.315.000
Separator	
JXBTL-G1/2 = M20*1.5	225.000
JXBTL-G3/4 = M25*1.5	298.000
JXBTL-G1 = M32*1.5	510.000
JXBTL-G1-1/4 = M40*1.5	739.000
JXBTL-G1-1/2 = M50*1.5	1.125.000
JXBTL-G2 = M63*1.5	1.687.000
JXBTL-G2-1/2 = M75*1.5	3.052.000
JXBTL-G3 = M88*1.5	5.460.000
JXBTL-G4 = M100*1.5	9.315.000

For Gland	Type	Price (Rp)
NPT1/2, G1/2, M20	JX-PVC01	9.200
NPT3/4, G3/4, M25	JX-PVC03	11.500
NPT1, G1, M32	JX-PVC05	22.900
NPT1-1/4, G1-1/4, M40	JX-PVC07	34.500
NPT1-1/2, G1-1/2, M50	JX-PVC09	45.900
NPT2, G2, M63	JX-PVC11	63.200
NPT2-1/2, G2-1/2, M75	JX-PVC13	91.900
NPT3, G3, M88	JX-PVC15	112.900
NPT4, G4, M100	JX-PVC17	321.700
Separator		
NPT1/2, G1/2, M20	JX-ET01	8.000
NPT3/4, G3/4, M25	JX-ET03	14.800
NPT1, G1, M32	JX-ET05	16.000
NPT1-1/4, G1-1/4, M40	JX-ET07	20.200
NPT1-1/2, G1-1/2, M50	JX-ET09	33.500
NPT2, G2, M63	JX-ET11	67.000
NPT2-1/2, G2-1/2, M75	JX-ET13	80.500
NPT3, G3, M88	JX-ET15	335.000
NPT4, G4, M100	JX-ET17	469.500

EXPLOSION - PROOF PRODUCT

EXPLOSION-PROOF PLUG & SOCKET



* Product Explosion proof Certification :

Specification :

* Material : Aluminium alloy

* Ingress protection : IP65

* Explosion protection : for YT,YZ,GZ series : Ex ec II C T4 Gc, Ex tc III C T130 °C Dc
for BCX53 series : Ex db eb II C T6, Ex tb III C T80 °C Db

* Ambient Temperature : -20°C to +50°C



Description	Pole	Ampere (A)	Type	Price (Rp)		
Explosion-proof Plug	3	15	15YT-3J	628.000		
	4		15YT-4J	673.000		
	5		15YT-5J	718.000		
	Explosion-proof Mobile / Wall Socket	3	32	32YT-3J	808.000	
		4		32YT-4J	853.000	
		5		32YT-5J	898.000	
		Explosion-proof Panel Socket	3	60	60YT-3J	1.033.000
			4		60YT-4J	1.123.000
			5		60YT-5J	1.212.000
Explosion-proof Plug & Wall Socket (In Line)	3		15	YZ-3K15	718.000	
	4			YZ-4K15	763.000	
	5			YZ-5K15	808.000	
	Explosion-proof Plug & Mobile Socket (Oblique Insertion)		3	32	YZ-3K32	898.000
			4		YZ-4K32	943.000
			5		YZ-5K32	988.000
		Explosion-proof Plug & Mobile Socket (Oblique Insertion)	3	60	YZ-3K60	1.123.000
			4		YZ-4K60	1.212.000
			5		YZ-5K60	1.302.000
Explosion-proof Plug & Mobile Socket (Oblique Insertion)			3	15	GZ-3K15	450.000
			4		GZ-4K15	495.000
			5		GZ-5K15	539.000
	Explosion-proof Plug & Mobile Socket (Oblique Insertion)		3	32	GZ-3K32	628.000
			4		GZ-4K32	673.000
			5		GZ-5K32	718.000
		Explosion-proof Plug & Mobile Socket (Oblique Insertion)	3	60	GZ-3K60	763.000
			4		GZ-4K60	854.000
			5		GZ-5K60	944.000
Explosion-proof Plug & Mobile Socket (Oblique Insertion)			3	15	BCX53-15/220Z-3	1.078.000
			4		BCX53-15/380Z-4	1.438.000
			5		BCX53-15/380Z-5	1.672.000
	Explosion-proof Plug & Mobile Socket (Oblique Insertion)		3	32	BCX53-32/220Z-3	2.944.000
			4		BCX53-32/380Z-4	2.944.000
			5		BCX53-32/380Z-5	3.442.000
		Explosion-proof Plug & Mobile Socket (Oblique Insertion)	3	15	BCX53-15/220X-3	1.476.000
			4		BCX53-15/380X-4	1.696.000
			5		BCX53-15/380X-5	1.866.000
Explosion-proof Plug & Mobile Socket (Oblique Insertion)			3	32	BCX53-32/220X-3	2.751.000
			4		BCX53-32/380X-4	3.667.000
			5		BCX53-32/380X-5	3.138.000
	Explosion-proof Plug & Mobile Socket (Oblique Insertion)		4	63	BCX53-63/380X-4	16.683.000

DISTRIBUTION BOX

METAL PANEL BOX



Spesifikasi :

- * IP protection : IP55
- * Cat Powder Coating RAL-7035.
- * Pintu panel dilapisi full karet / foam polyurethane gasket & talang air.
- * Engsel pintu bisa dilepas, sehingga side pintu dapat ditukar ke sisi kanan/kiri.
- * Dilengkapi lobang incoming yang sudah dilengkapi penutup dan seal karet.
- * Sudah dilengkapi titik grounding yang terhubung body dan pintu panel.
- * Panel Outdoor ukuran tinggi (H) full diluar Topi.
- * Type panel pintu luar.

INDOOR PANEL BOX



Type	Size (cm)			Thickness (mm)			Berat (Kg)	Price /Unit (Rp)
	H	W	D	Body	Door	Plate		
FMBI302015	30	20	15	1,0	1,0	1,0	2,6	226.500
FMBI302515	30	25	15	1,0	1,0	1,0	3,2	254.800
FMBI403020	40	30	20	1,0	1,0	1,0	4,7	354.000
FMBI504020	50	40	20	1,0	1,0	1,0	9,0	574.000
FMBI604020	60	40	20	1,0	1,0	1,0	9,7	691.000
FMBI605020	60	50	20	1,0	1,0	1,0	12,0	842.000
FMBI705020	70	50	20	1,2	1,2	1,2	14,9	992.700
FMBI806030	80	60	30	1,2	1,2	1,2	24,0	1.584.900
FMBI1008030	100	80	30	1,2	1,2	1,2	36,3	2.336.400
FMBI1208030	120	80	30	1,2	1,2	1,2	42,5	2.715.600

OUTDOOR PANEL BOX



Type	Size (cm)			Thickness (mm)			Berat (Kg)	Price /Unit (Rp)
	H	W	D	Body	Door	Plate		
FMBO403020	40	30	20	1,0	1,0	1,0	5,2	457.500
FMBO504020	50	40	20	1,0	1,0	1,0	9,5	710.700
FMBO604020	60	40	20	1,0	1,0	1,0	10,7	849.700
FMBO605020	60	50	20	1,0	1,0	1,0	13,1	988.500
FMBO705020	70	50	20	1,2	1,2	1,2	16,4	1.175.700
FMBO806030	80	60	30	1,2	1,2	1,2	24,6	1.821.600

DISTRIBUTION BOX

STAINLES STEEL PANEL BOX



Spesifikasi :

- * IP protection : IP55
- * Material anti karat Stainles steel 304
- * Pintu panel dilapisi full karet / foam polyurethane gasket & talang air.
- * Engsel pintu bisa dilepas, sehingga side pintu dapat ditukar ke sisi kanan/kiri.
- * Sudah dilengkapi titik grounding yang terhubung body dan pintu panel.
- * Panel Outdoor ukuran tinggi (H) full diluar Topi.
- * Type panel pintu luar.

INDOOR PANEL BOX

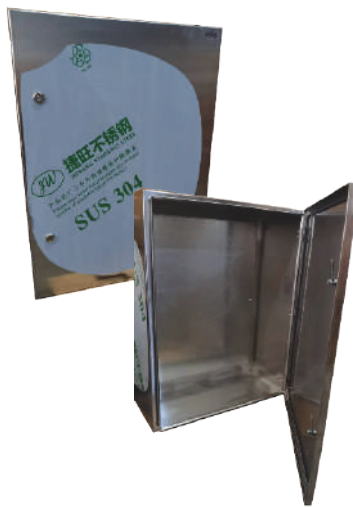

Type	Size (cm)			Thickness (mm)			Berat (Kg)	Price /Unit (Rp)
	H	W	D	Body	Door	Plate		
FSBI302515	30	25	15	1,2	1,2	1,2	4,1	1.230.500
FSBI403020	40	30	20	1,2	1,2	1,2	6,4	1.725.000
FSBI504020	50	40	20	1,2	1,2	1,2	9,1	2.346.000
FSBI604020	60	40	20	1,5	1,5	1,2	13,6	3.335.000
FSBI605020	60	50	20	1,5	1,5	1,2	16,0	3.829.500
FSBI705020	70	50	20	1,5	1,5	1,2	18,4	4.255.000
FSBI806030	80	60	30	1,5	1,5	1,2	26,8	6.543.500
FSBI1008030	100	80	30	1,5	1,5	1,2	40,6	9.878.500

OUTDOOR PANEL BOX



Type	Size (cm)			Thickness (mm)			Berat (Kg)	Price /Unit (Rp)
	H	W	D	Body	Door	Plate		
FSBO403020	40	30	20	1,2	1,2	1,2	7,2	1.944.000
FSBO504020	50	40	20	1,2	1,2	1,2	10,4	2.596.000
FSBO604020	60	40	20	1,5	1,5	1,2	14,8	3.695.000
FSBO605020	60	50	20	1,5	1,5	1,2	17,4	4.215.000
FSBO705020	70	50	20	1,5	1,5	1,2	19,8	4.794.000
FSBO806030	80	60	30	1,5	1,5	1,2	44,0	7.389.000

DISTRIBUTION BOX



POLYCARBONATE PANEL BOX



Description	Size (WxHxD)mm	Type	Price (Rp)
* Material : PC (Polycarbonate) * Protection Degree : IP67 * Temperature max. 80-100 °C * High corrosion resistance * Fire retardant	400x300x200	FBOX403020	2.385.000
	600x400x220	FBOX604022	3.795.000
	800x600x250	FBOX806025	6.075.000



FIBER GLASS PANEL BOX WITH STEEL BASE PLATE



Description	Size	Type	Price (Rp)
* Material : Fiber glass/SMC * Protection Degree : IP66 * Temperature : -40°C to +120°C	300x250x140	RH302514	900.000
	400x300x200	RH403020	1.243.000
	500x400x200	RH504020	1.638.000
	600x400x230	RH604023	2.090.000
	600x500x230	RH605023	2.486.000
	800x600x300	RH806030	4.181.000



SWITCH BOX WITH CLASPS (SOLID COVER) WITH BASE PLATE



Description	Size (WxHxD)mm	Type	Price (Rp)
* Material : ABS * Protection Degree : IP66	300x200x170	SP-PCG-302017	542.000
	400x300x170	SP-PCG-403017	756.000
	500x400x200	SP-PCG-504020	1.310.000
	600x400x220	SP-PCG-604022	1.667.000



SWITCH BOX WITH CLASPS (TRANSPARENT COVER) WITH BASE PLATE



Description	Size (WxHxD)mm	Type	Price (Rp)
* Material : ABS * Protection Degree : IP66	300x200x170	SP-PCT-302017	705.000
	400x300x170	SP-PCT-403017	1.099.000
	500x400x200	SP-PCT-504020	1.612.000
	600x400x220	SP-PCT-604022	2.152.000



SWITCH BOX WITH STAINLESS CLASPS (SOLID COVER) WITH BASE PLATE



Description	Size (WxHxD)mm	Type	Price (Rp)
* Material : ABS * Protection Degree : IP66	160x260x100	BG-162610	364.000
	190x280x140	BG-192814	512.000
	200x300x130	BG-203013	602.000
	350x250x150	BG-352515	629.000
	300x300x180	BG-303018	835.500
	280x380x130	BG-283813	867.500
	300x400x180	BG-304018	1.060.000

JUNCTION BOX



SWITCH BOX SCREW / JUNCTION BOX (SOLID COVER)



Description	SIZE (PxLxT)mm	TYPE	Price (Rp)	
			BOX	Base Plate
* Material : ABS * Protection Degree : IP66	110x80x70	DS-AG-0811	58.000	22.600
	110x80x85	DS-AG-0811-1	69.000	22.600
	130x80x70	DS-AG-0813	73.000	22.600
	125x125x75	DS-AG-1212-S	91.000	24.800
	125x125x100	DS-AG-1212	106.000	24.800
	175x125x100	DS-AG-1217-1	121.000	24.800
	200x150x100	DS-AG-1520	141.000	24.800
	250x150x100	DS-AG-1525	169.000	31.600
	200x200x130	DS-AG-2020	193.000	36.200
	280x190x130	DS-AG-1928	296.000	81.400
	280x280x130	DS-AG-2828	426.000	85.900
	280x340x180	DS-AG-3428	622.000	88.000
	280x380x180	DS-AG-3828	678.000	96.000

SWITCH BOX SCREW / JUNCTION BOX (TRANSPARENT COVER)



Description	SIZE (PxLxT)mm	TYPE	Price (Rp)	
			BOX	Base Plate
* Material : ABS * Protection Degree : IP66	110x80x70	DS-AT-0811	60.000	21.600
	130x80x70	DS-AT-0813	85.900	22.600
	125x125x100	DS-AT-1212	118.000	24.800
	175x125x100	DS-AT-1217-1	146.000	24.800
	200x150x100	DS-AT-1520	169.000	24.800
	250x150x100	DS-AT-1525	190.000	31.600
	200x200x130	DS-AT-2020	205.000	36.200
	280x190x130	DS-AT-1928	325.000	81.400
	280x280x130	DS-AT-2828	485.000	85.900

DURADUS BOX



Description	SIZE (PxLxT)mm	Hole Size (mm)	Qty/Carton	TYPE	Price (Rp)
* Material : ABS	80x80x50	25	200	CHA-RA-0808	14.200
* Protection Degree : IP65	100x100x70	25	100	CHA-RA-1010	23.000
* Water proof	150x110x70	25	60	CHA-RA-1115	44.100
* Rubber sealing ring	150x150x70	25	60	CHA-RA-1515	46.700
* Color : white	200x155x80	36	40	CHA-RA-1520	60.600

DISTRIBUTION BOX



MCB BOX

Description :

- * Protection grade : IP40
- * Material : Full ABS



Installation	Grup	Type	Price (Rp)
Flush - Mounted (IN BOW)	4	FMCBB4F	61.000
	6	FMCBB6F	72.000
	8	FMCBB8F	86.000
	12	FMCBB12F	120.000
	18	FMCBB18F	179.000
	24	FMCBB24F	249.000
Surface - Mounted (OUT BOW)	4	FMCBB4S	62.000
	6	FMCBB6S	75.000
	8	FMCBB8S	88.000
	12	FMCBB12S	126.000
	18	FMCBB18S	182.000
	24	FMCBB24S	250.000
Box MCB Plate (Penutup Lobang MCB Box)	6	FMCBP-6	6.400

WIRING ACCESSORIES

CABLE CHAIN / CARRIER



Description :

- * Material : Nylon PA66
- * Model : Bridge / Tangga
- * Standard packing per 1 Meter, Include bracket



Type	Inner Size (mm)		Outer Size (mm)		Radius (mm)	Price/Meter (Rp)
	H	W	H	W		
T1020QR28	10	20	15	28	28	138.900
T1030QR28	10	30	15	38		155.800
T1520QR28	15	20	20	30	28	155.800
T1540QR28	15	40	20	40		168.700
T1825QR38	18	25	23	36	38	175.200
T1837QR38	18	37	23	47		185.700
T1850QR38	18	50	23	60		200.000
H2538QR75	25	38	40	56	75	337.500
H2557QR75	25	57	40	75		369.900
H2577QR75	25	77	40	95		402.400
H3575QR100	35	75	55	100	100	569.900
H35100QR100	35	100	55	125		616.600
H35125QR100	35	125	55	150		662.000
H4575QR100	45	75	65	105	100	677.500
H45100QR100	45	100	65	130		693.200
H45125QR100	45	125	65	155		724.400
H45150QR100	45	150	65	180		769.800

HEAT RESISTANCE CABLE



Size (mm)	Type	Qty/roll (M)	Price / Roll (Rp)
0,75	FHRC-0.75	100	688.000
1,00	FHRC-1.0	100	811.000
1,50	FHRC-1.5	100	1.052.000
2,00	FHRC-2.0	100	1.278.000
2,50	FHRC-2.5	100	1.587.000
4,00	FHRC-4.0	100	2.475.000
6,00	FHRC-6.0	100	3.988.000
10,00	FHRC-10	100	6.875.000

NYLON CABLE PULLER (PENARIK KABEL)



Description	Color	Diameter (mm)	Length (M)	Type	Price (Rp)
* Nylon, With Brass terminals	Yellow	4,0	15	NCP-4015	65.100
		4,0	20	NCP-4020	81.900
		4,0	30	NCP-4030	117.600

SPRING PIPE BENDER (PENEKUK PIPA PVC)



Type	Size (mm)	Function	Price (Rp)
SPB-20	20	For Pipe 20mm	39.900
SPB-25	25	For Pipe 25mm	52.500

DECORATION PVC DUCTING

Specification :

- ** Non-brittle, high-impact strength trunking owing to premium PVC formulation"
- * Fire retardant capability
- * Refinded, smooth and compact
- * Tight and secured locking
- * Quick and easy installation
- * Color : White (Putih)



PVC CABLE TRUNKING DUCT

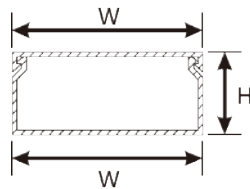

Type	Size			Qty/Box (pcs)	Price/pcs (Rp)
	Width (mm)	Height (mm)	Length (m)		
FTD1616-3	16	16	2,9	25	9.000
FTD2010-3	20	10	2,9	30	9.300
FTD2516-3	25	16	2,9	25	12.800
FTD3015-3	30	15	2,9	20	16.200
FTD4025-3	40	25	2,9	12	21.100
FTD3919-3	39	19	2,9	15	21.000
FTD5050-3	50	50	2,9	4	47.500
FTD6040-3	60	40	2,9	5	47.900
FTD7575-3	75	75	2,9	2	83.400
FTD8040-3	80	40	2,9	3	97.400
FTD10060-3	100	60	2,9	2	98.200
FTD100100-3	100	100	2,9	2	162.000
FTD1616-2	16	16	1,7	25	5.300
FTD2010-2	20	10	1,7	30	5.500
FTD2516-2	25	16	1,7	25	7.500
FTD3015-2	30	15	1,7	20	9.500
FTD4025-2	40	25	1,7	12	12.400
FTD3919-2	39	19	1,7	15	12.400
FTD5050-2	50	50	1,7	4	27.800
FTD6040-2	60	40	1,7	5	28.100
FTD7575-2	75	75	1,7	2	48.900
FTD8040-2	80	40	1,7	3	57.100
FTD10060-2	100	60	1,7	2	57.600
FTD100100-2	100	100	1,7	2	93.000

PVC FLOOR TRUNKING DUCT

Remark:

- * This item can make with the tape to attached the floor.



Type	Size			Qty/Box (pcs)	Price/pcs (Rp)
	Width (mm)	Height (mm)	Length (m)		
FFD2510-3	25	10	2,9	20	27.100
FFD3515-3	35	15	2,9	15	31.600
FFD5015-3	50	15	2,9	10	53.100
FFD7020-3	70	20	2,9	10	94.800
FFD2510-2	25	10	1,7	20	15.900
FFD3515-2	35	15	1,7	15	18.600
FFD5015-2	50	15	1,7	10	31.100
FFD7020-2	70	20	1,7	10	55.600

PVC TC - DUCT

Remark:

- * This item can make with the tape to attached.

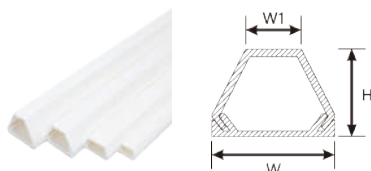

Type	Size			Qty/Box (pcs)	Price/pcs (Rp)
	Width (mm)	Height (mm)	Length (m)		
FTC-1	13	7	1,0	50	3.300
FTC-2	18	9	1,0	30	4.700
FTC-3	19	10	1,0	30	5.500
FTC-4	20	14	1,0	30	7.500
FTC-5	24	16	1,0	25	8.700
FTC-6	26	20	1,0	20	9.200

PVC CABLE DUCT



PVC CABLE DUCT (DENGAN SLOT / LUBANG) WARNA ABU-ABU



Type	Dimension		Length (M)	Qty/Ctn	Price / Pcs (Rp)
	W (MM)	H (MM)			
PWD-2525	25	25	1,7	70	26.100
PWD-2545	25	45	1,7	42	35.600
PWD-3232	32	32	1,7	40	37.000
PWD-3245	32	45	1,7	42	39.600
PWD-4545	45	45	1,7	30	47.500
PWD-4565	45	65	1,7	20	59.400
PWD-6565	65	65	1,7	16	73.900

PVC CABLE DUCT (TANPA SLOT / LUBANG) WARNA ABU-ABU



Type	Dimension		Length (M)	Qty/Ctn	Price / Pcs (Rp)
	W (MM)	H (MM)			
PSD-2525	25	25	1,7	70	29.000
PSD-2545	25	45	1,7	42	38.600
PSD-3232	32	32	1,7	40	41.400
PSD-3245	32	45	1,7	42	44.200
PSD-4545	45	45	1,7	30	52.400
PSD-4565	45	65	1,7	20	64.900
PSD-6565	65	65	1,7	16	81.400

PVC CABLE DUCT (TANPA SLOT / LUBANG) WARNA PUTIH



Type	Dimension		Length (M)	Qty/Ctn	Price / Pcs (Rp)
	W (MM)	H (MM)			
PSD-2525	25	25	1,7	70	31.700
PSD-2545	25	45	1,7	42	46.900
PSD-3232	32	32	1,7	40	51.100
PSD-3245	32	45	1,7	42	55.200
PSD-4545	45	45	1,7	30	63.500
PSD-4565	45	65	1,7	20	77.300
PSD-6565	65	65	1,7	16	103.500

FLEXIBLE CONDUIT

PVC COATED FLEXIBLE METAL CONDUIT

Description :

- * Galvanized steel core, PVC jacketed
- * Light style, highly flexibility and liquid-tightness
- * Water proof, corrosion resistant, sunlight resistant
- * For massa production equipment, machine tools, any morrow space for . electrical wiring aplications
- * Temperature range from -100C to +700C
- * PVC color Black, Grey, other colors are available upon request



* Bersertifikat :



Type	Size (inch)	Diameter (mm)	Lenght / Roll (m)	Price / Roll (Rp)
PTN-13 PVC	3/8"	12	50	462.000
PTN-16 PVC	1/2"	16	50	537.000
PTN-21 PVC	3/4"	20	50	647.000
PTN-26 PVC	1"	25	50	850.000
PTN-32 PVC	1-1/4"	32	25	550.000
PTN-40 PVC	1-1/2"	38	25	794.000
PTN-51 PVC	2"	51	20	893.000
PTN-65 PVC	2 - 1/2"	64	20	3.333.000
PTN-75 PVC	3"	75	20	3.920.000
PTN-100 PVC	4"	100	10	3.665.000

CORRUGATED FLEXIBLE CONDUIT PVC

Spesifikasi :

- * Material PP,PE,HDPE
- * Tersedia Warna Putih dan Hitam
- * Dipergunakan untuk instalasi listrik



Type	Size		Price/Roll (Rp)
	Inner (mm)	Outner (mm)	
DR-16	10,7 ± 0,4	16,0 ± 0,4	73.000
DR-20	15,0 ± 0,4	20,0 ± 0,4	77.000
DR-25	20,0 ± 0,4	24,0 ± 0,4	107.000

FLEXIBLE CONDUIT

FLEXIBLE METAL CONDUIT



Description :

- * Galvanized steel core
- * Highly flexibility and impact resistant
- * Corrosion resistant
- * For massa production equipment, machine tools, any morrow space for electrical wiring aplications

* Bersertifikat :

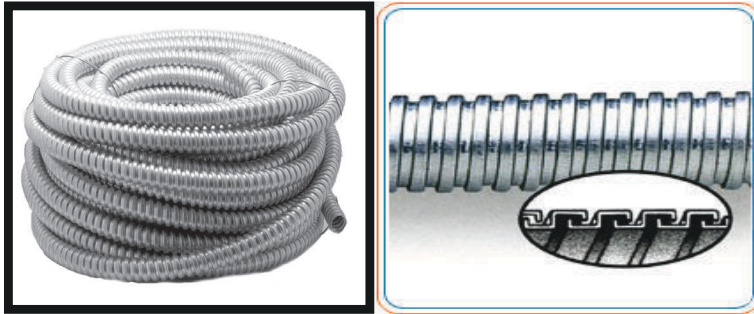

Type	Size (inch)	Diameter (mm)	Lenght / Roll (m)	Price / Roll (Rp)
PTN-16 GV	1/2"	16	50	380.000
PTN-21 GV	3/4"	20	50	493.000
PTN-26 GV	1"	25	50	616.000
PTN-32 GV	1-1/4"	32	25	483.000
PTN-40 GV	1-1/2"	38	25	693.000
PTN-51 GV	2"	51	20	662.000

HI-FLEX

Description :

- * Outside layer is Stainless Steel belt and the middle layer is the steel strip.
- * the inner layer is the water-tolerant electrical paper.
- * The never rust surface, shatter-proof, high corrosion resistance.
- * further improved tensile strength and radial compression force.
- * Applied to decoration in various dry places and the field of fire control, lighting, instrumentation, electrical equipment installation, construction, transport and textile, etc.



Product Code	Type	size	Outside Diameter (M)	Lenght / Roll (M)	Price List (Rp)
FJE17	FZ-4 17	1/2"	21,5	50	3.800.000
FJE24	FZ-4 24	3/4"	28,8	25	2.400.000
FJE30	FZ-4 30	1"	34,9	25	2.900.000
FJE38	FZ-4 38	1-1/4"	42,9	25	3.500.000

CONNECTOR

FOR FLEXIBEL CONDUIT



STRAIGHT TYPE (FLEXIBLE TO BOX) CONNECTOR



Type	Size for flexible (inch)	Price (Rp)
DPJ-12	3/8"	12.600
DPJ-16	1/2"	14.300
DPJ-20	3/4"	18.900
DPJ-25	1"	27.000
DPJ-32	1-1/4"	41.900
DPJ-38	1-1/2"	60.900
DPJ-51	2"	93.200
DPJ-63	2-1/2"	180.000
DPJ-78	3"	220.000
DPJ-102	4"	368.000

STRAIGHT TYPE (FLEXIBLE TO PIPE) COUPLING



DKJ



DPN

Type	Size for flexible (inch)	Size for Pipe	Price (Rp)
DKJ/DPN-12	3/8"	-	12.600
DKJ/DPN-16	1/2"	E-19/G-16	14.300
DKJ/DPN-20	3/4"	E-25/G-22	18.900
DKJ/DPN-25	1"	E-31/G-28	27.000
DKJ/DPN-32	1-1/4"	E-39/G-36	41.900
DKJ/DPN-38	1-1/2"	E-51/G-42	60.900
DKJ/DPN-51	2"	E-63/G-54	93.200
DKJ/DPN-63	2-1/2"	E-75/G-70	180.000
DKJ/DPN-78	3"	G-82	220.000
DKJ/DPN-102	4"	G-104	368.000

ANGLE TYPE (FLEXIBLE TO BOX) ELBOW 90° CONNECTOR



Type	Size for flexible (inch)	Price (Rp)
DWJ-12	3/8"	23.600
DWJ-16	1/2"	29.500
DWJ-20	3/4"	37.700
DWJ-25	1"	64.900
DWJ-32	1-1/4"	96.700
DWJ-38	1-1/2"	135.700
DWJ-51	2"	224.200

STEEL PIPE CONDUIT



STEEL PIPE CONDUIT TYPE E

Description:

- * Comply with Japan Industrial Standard (JIS)
- * Material from high quality strip steel coils and in line hot-dip galvanizing
- * High corrosion resistance
- * Provide mechanical protection for cables & easy cables pushing and pulling
- * Easy and accurate bending

PLAIN CONDUIT /THREADLESS (PIPA POLOS TANPA DRAT)



Product Code	Type	Size (inch)	Outside Diameter (mm)	Wall Thickness (mm)	Length (M)	Price List (Rp)
FJE190	E19	3/4"	19,1	1,2	3,66	102.800
FJE250	E25	1"	25,4	1,2	3,66	133.200
FJE310	E31	1-1/4"	31,8	1,2	3,66	187.800
FJE390	E39	1-1/2"	38,1	1,2	3,66	226.700
FJE510	E51	2"	50,8	1,2	3,66	334.800
FJE630	E63	2-1/2"	63,5	1,6	3,66	393.600
FJE750	E75	3"	76,2	1,6	3,66	565.800

SADDLES CLAMP FOR PIPE E TYPE



Type	For Pipe Type	Size (inch)	Price List (Rp)
SCE190	E19	3/4"	1.600
SCE250	E25	1"	2.000
SCE310	E31	1-1/4"	2.800
SCE390	E39	1-1/2"	3.300
SCE510	E51	2"	5.800
SCE630	E63	2-1/2"	12.700

COUPLING METAL



Type	For Pipe Type	Size (inch)	Price List (Rp)
CME190	E19	3/4"	9.300
CME250	E25	1"	13.300
CME310	E31	1-1/4"	17.500
CME390	E39	1-1/2"	30.200
CME510	E51	2"	38.600
CME630	E63	2-1/2"	117.100
CME750	E75	3"	175.100

STEEL PIPE CONDUIT

ACCESSORIES FOR PIPE CONDUIT TYPE E



SET SCREW CONNECTOR TYPE - E (PIPE TO BOX)



Type	For Pipe Type	Size (inch)	Price List (Rp)
SSE190	E19	3/4"	14.500
SSE250	E25	1"	18.100
SSE310	E31	1-1/4"	25.400
SSE390	E39	1-1/2"	49.500
SSE510	E51	2"	99.000
SSE630	E63	2-1/2"	125.600

90 DEGREE CONDUIT ELBOW



Type	For Pipe Type	Size (inch)	Price List (Rp)
CEE190	E19	3/4"	31.400
CEE250	E25	1"	55.500
CEE310	E31	1-1/4"	67.600
CEE390	E39	1-1/2"	91.800
CEE510	E51	2"	161.800
CEE630	E63	2-1/2"	469.700
CEE750	E75	3"	734.200

SQUARE OUTLET BOX DS-3744



Type	For Pipe Type	Size (inch)	Price List (Rp)
SOB190	E & G	3/4"	42.000

size : P x L x H (102 mm x 102 mm x 44 mm)

STEEL PIPE CONDUIT

ACCESSORIES FOR PIPE CONDUIT TYPE E



CIRCULAR JUNCTION BOX 1 WAY - STEEL



Type	For Pipe Type	Size (inch)	Price List (Rp)
JBE101	E19	3/4"	59.200
JBE102	E25	1"	72.500
JBE 103	E31	1-1/4"	141.300
JBE 104	E39	1-1/2"	396.100
JBE105	E51	2"	631.500

CIRCULAR JUNCTION BOX 2 WAY - STEEL (THROUGH)



Type	For Pipe Type	Size (inch)	Price List (Rp)
JBE211	E19	3/4"	66.400
JBE212	E25	1"	78.500
JBE213	E31	1-1/4"	158.200
JBE214	E39	1-1/2"	413.000
JBE215	E51	2"	706.400

CIRCULAR JUNCTION BOX 2 WAY - STEEL (ANGLE)



Type	For Pipe Type	Size (inch)	Price List (Rp)
JBE201	E19	3/4"	66.400
JBE202	E25	1"	78.500
JBE203	E31	1-1/4"	158.200
JBE204	E39	1-1/2"	413.000
JBE205	E51	2"	706.400

CIRCULAR JUNCTION BOX 3 WAY - STEEL



Type	For Pipe Type	Size (inch)	Price List (Rp)
JBE301	E19	3/4"	69.600
JBE302	E25	1"	83.300
JBE303	E31	1-1/4"	184.700
JBE304	E39	1-1/2"	427.500
JBE305	E51	2"	730.500

CIRCULAR JUNCTION BOX 4 WAY - STEEL



Type	For Pipe Type	Size (inch)	Price List (Rp)
JBE401	E19	3/4"	86.900
JBE402	E25	1"	97.200
JBE403	E31	1-1/4"	193.200
JBE404	E39	1-1/2"	518.000
JBE405	E51	2"	754.700

STEEL PIPE CONDUIT

ACCESSORIES FOR PIPE CONDUIT TYPE E



BUSHING



Type	For Pipe Type	Size (inch)	Price List (Rp)	
			No Insulated	Insulated
BSE190	E19	3/4"	12.100	13.900
BSE250	E25	1"	20.500	22.300
BSE310	E31	1-1/4"	26.000	28.400
BSE390	E39	1-1/2"	33.800	36.200
BSE510	E51	2"	60.400	65.800
BSE630	E63	2-1/2"	99.000	108.700
BSE750	E75	3"	132.800	144.900

LOCK NUT



Type	For Pipe Type	Size (inch)	Price List (Rp)
LNE190	E19	3/4"	4.300
LNE250	E25	1"	8.000
LNE310	E31	1-1/4"	9.900
LNE390	E39	1-1/2"	11.200
LNE510	E51	2"	18.700
LNE630	E63	2-1/2"	29.600
LNE750	E75	3"	36.200

SURFACE SWITCH BOX 1 WAY ; MATERIAL STEEL



Type	For Pipe Type	Size (inch)	Price List (Rp)
SSBS191	E -19	3/4"	72.500
SSBS 251	E-25	1"	82.100

SURFACE SWITCH BOX 2 WAY; MATERIAL STEEL



Type	For Pipe Type	Size (inch)	Price List (Rp)
SSBS192	E -19	3/4"	111.100
SSBS252	E-25	1"	120.800

STEEL PIPE CONDUIT

STEEL PIPE CONDUIT TYPE G



Description:

- * Comply with Japan Industrial Standard (JIS)
- * Material from high quality strip steel coils and hot-dip galvanizing
- * High corrosion resistance
- * Provide mechanical protection for cables & easy cables pushing and pulling
- * Easy and accurate bending

PLAIN CONDUIT /THREADED (PIPA DENGAN DRAT)

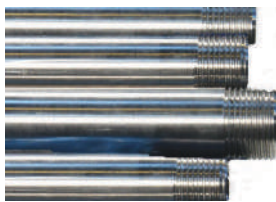

Product Code	Type	Size (inch)	Outside Diameter (mm)	Wall Thickness (mm)	Length (M)	Price List (Rp)
FJG160	G16	1/2"	21	2,30	3,66	202.900
FJG220	G22	3/4"	26,5	2,30	3,66	264.400
FJG280	G28	1"	33,3	2,50	3,66	367.100
FJG360	G36	1-1/4"	41,9	2,50	3,66	467.300
FJG420	G42	1-1/2"	47,8	2,80	3,66	534.900
FJG540	G54	2"	59,6	2,80	3,66	749.900
FJG700	G70	2-1/4"	75,2	2,80	3,66	973.200

SADDLES CLAMP FOR PIPE G TYPE



Type	For Pipe Type	Size (inch)	Price List (Rp)
SCG160	G16	1/2"	1.600
SCG220	G22	3/4"	2.000
SCG280	G28	1"	2.800
SCG360	G36	1-1/4"	3.300
SCG420	G42	1-1/2"	5.800
SCG540	G54	2"	12.700

COUPLING METAL



Type	For Pipe Type	Size (inch)	Price List (Rp)
CMG16	G16	1/2"	11.600
CMG22	G22	3/4"	15.800
CMG28	G28	1"	25.000
CMG36	G36	1-1/4"	39.900
CMG42	G42	1-1/2"	54.300
CMG54	G54	2"	93.000
CMG70	G70	2-1/4"	135.200

STEEL PIPE CONDUIT

ACCESSORIES FOR PIPE CONDUIT TYPE G



SET SCREW CONNECTOR TYPE - G (PIPE TO BOX)



Type	For Pipe Type	Size (inch)	Price List (Rp)
SSG160	G16	1/2"	28.400
SSG220	G22	3/4"	52.500
SSG280	G28	1"	65.800
SSG360	G36	1-1/4"	104.900
SSG420	G42	1-1/2"	166.600
SSG540	G54	2"	283.500

90 DEGREE CONDUIT ELBOW



Type	For Pipe Type	Size (inch)	Price List (Rp)
CEG16	G16	1/2"	60.400
CEG22	G22	3/4"	70.700
CEG28	G28	1"	102.700
CEG36	G36	1-1/4"	153.300
CEG42	G42	1-1/2"	298.200
CEG54	G54	2"	408.100
CEG70	G70	2-1/4"	788.600

SQUARE OUTLET BOX DS-3744



Type	For Pipe Type	size	Price List (Rp)
SOB190	E & G	3/4"	42.000

size : P x L x H (102 mm x 102 mm x 44 mm)

STEEL PIPE CONDUIT

ACCESSORIES FOR PIPE CONDUIT TYPE G



CIRCULAR JUNCTION BOX 1 WAY - STEEL



Type	For Pipe Type	Size (inch)	Price List (Rp)
JBG101	G16	1/2"	80.300
JBG102	G22	3/4"	102.700
JBG103	G28	1"	229.400
JBG104	G36	1-1/4"	466.100
JBG105	G42	1-1/2"	705.200
JBG106	G54	2"	966.000

CIRCULAR JUNCTION BOX 2 WAY - STEEL (THROUGH)



Type	For Pipe Type	Size (inch)	Price List (Rp)
JBG211	G16	1/2"	87.500
JBG212	G22	3/4"	112.400
JBG213	G28	1"	241.500
JBG214	G36	1-1/4"	507.200
JBG215	G42	1-1/2"	770.400
JBG216	G54	2"	1.123.000

CIRCULAR JUNCTION BOX 2 WAY - STEEL (ANGLE)



Type	For Pipe Type	Size (inch)	Price List (Rp)
JBG201	G16	1/2"	87.500
JBG202	G22	3/4"	112.400
JBG203	G28	1"	241.500
JBG204	G36	1-1/4"	507.200
JBG205	G42	1-1/2"	770.400
JBG206	G54	2"	1.123.000

CIRCULAR JUNCTION BOX 3 WAY - STEEL



Type	For Pipe Type	Size (inch)	Price List (Rp)
JBG301	G16	1/2"	100.300
JBG302	G22	3/4"	120.800
JBG303	G28	1"	247.500
JBG304	G36	1-1/4"	501.100
JBG305	G42	1-1/2"	873.000
JBG306	G54	2"	1.183.400

CIRCULAR JUNCTION BOX 4 WAY - STEEL



Type	For Pipe Type	Size (inch)	Price List (Rp)
JBG401	G16	1/2"	109.900
JBG402	G22	3/4"	135.200
JBG403	G28	1"	253.600
JBG404	G36	1-1/4"	516.800
JBG405	G42	1-1/2"	946.700
JBG406	G54	2"	1.207.500

Price List 2024

STEEL PIPE CONDUIT

ACCESSORIES FOR PIPE CONDUIT TYPE G



BUSHING



Type	For Pipe Type	Size (inch)	Price List (Rp)	
			No Insulated	Insulated
BHG16	G16	1/2"	12.100	13.900
BHG22	G22	3/4"	20.500	22.300
BHG28	G28	1"	26.000	28.400
BHG36	G36	1-1/4"	33.800	36.200
BHG42	G42	1-1/2"	60.400	65.800
BHG54	G54	2"	99.000	108.700
BHG70	G70	2-1/4"	132.800	144.900

LOCK NUT



Type	For Pipe Type	Size (inch)	Price List (Rp)
LNG16	G16	1/2"	4.300
LNG22	G22	3/4"	8.000
LNG28	G28	1"	9.900
LNG36	G36	1-1/4"	11.200
LNG42	G42	1-1/2"	18.700
LNG54	G54	2"	29.600
LNG70	G70	2-1/4"	36.200

SURFACE SWITCH BOX 1 WAY ; MATERIAL STEEL



Type	For Pipe Type	Size (inch)	Price List (Rp)
SSBS161	G - 16	1/2"	88.100
SSBS 221	G - 22	3/4"	105.000

SURFACE SWITCH BOX 2 WAY; MATERIAL STEEL



Type	For Pipe Type	Size (inch)	Price List (Rp)
SSBS 162	G - 16	1/2"	119.500
SSBS 222	G - 22	3/4"	138.900

STEEL PIPE CONDUIT



CLAMP RACE WAY



Type	For Pipe Type	Size (inch)	Price List (Rp)
CRW16	E & G	1/2"	6.600
CRW22	E & G	3/4"	7.000
CRW28	E & G	1"	8.800
CRW36	E & G	1-1/4"	9.200
CRW42	E & G	1-1/2"	11.000
CRW54	E & G	2"	12.600
CRW70	E & G	2-1/2"	15.100
CRW82	E & G	3"	17.700
CRW104	E & G	4"	26.600

CLAMP PYLUCK



Type	For Pipe Type	Size (inch)	Price List (Rp)
CPL16	E & G	1/2"	5.500
CPL22	E & G	3/4"	6.300
CPL28	E & G	1"	6.700
CPL36	E & G	1-1/4"	7.700
CPL42	E & G	1-1/2"	9.300
CPL54	E & G	2"	11.100
CPL70	E & G	2-1/2"	12.100
CPL82	E & G	3"	13.300

BODY PYLUCK



Type	Price List (Rp)
PH-1S	10.200
PH-1W	11.600
PH-2W	37.500
PH-3W	65.800
PH-7W	132.800

FORT By Kinco

INDUSTRIAL AUTOMATION & INTELLIGENT MANUFACTURING



VARIABLE FREQUENCY DRIVE / INVERTER

HUMAN MACHINE INTERFACE

PROGRAMMABLE LOGIC CONTROLLER (PLC)

SERVO MOTORS & DRIVER

VARIABLE FREQUENCY DRIVE (VFD)

INVERTER



CV-20 Series / KC-100 (Economic series)

Specification :

- * Output frequency 0 - 300Hz
- * V/F control and Setable V/F curves
- * Auto torque boost and auto slip compensation function
- * Standard equipped Modbus (RS485 baud rate up to 19200bps)
- * Without braking system & Overheat detection.
- * DIN-rail mounting & Wall mounting
- * Application for : Pump & Fan



CV20 Series



KC100 series

Input Volatge	Output Voltage	Power Range (kW)	Type	Price (Rp)
1Phase / 220VAC	3 Phase / 220VAC	0,4	CV20-2S-0004G / KC100-2S-0R40G	2.100.000
		0,75	CV20-2S-0007G / KC100-2S-0R75G	2.200.000
		1,5	CV20-2S-0015G / KC100-2S-01R5G	2.500.000
		2,2	KC100-2S-02R2G	Call us
3 Phase / 380VAC	3 Phase / 380VAC	0,75	CV20-4T-0007G / KC100-4T-0R75G	2.900.000
		1,5	CV20-4T-0015G / KC100-4T-01R5G	3.100.000
		2,2	CV20-4T-0022G / KC100-4T-02R2G	3.200.000
		3,7	CV20-4T-0037G / KC100-4T-03R7G	4.300.000

Spare Parts VFD / INVERTER



Description	Type	Price (Rp)
Encoder Card for FV20	FV20-UVWPG	1.400.000
Cable keypad FLAT for FV20 (1 Meter)	FC-KF-01	100.000
Cable keypad LAN for FV20 (2 Meter)	FC-KL-02	80.000
Keypad / Display for FV20	FV20-KP	400.000

VARIABLE FREQUENCY DRIVE (VFD)

INVERTER

FORT By Kinco



Braking Unit & Braking Resistor



Description	Type	Price (Rp)
Braking Unit Rated 25A Max 60A Duty Duty 10%	SVB-4T-0550	10.450.000
Braking Unit Rated 85A Max 200A Duty 10%	SVB-4T-1600	13.750.000
Braking Unit Rated 160A Max 450A Duty 10%	BKBU4400N	24.145.000
Braking Resistor Rated 132 Ohm 1KW Tolerance +/-5%	BKRXLG-1000W-132RJ	Call us
Braking Resistor Rated 132 Ohm 1,5KW Tolerance +/-5%	BKRXLG-1500W-106RJ	Call us
Braking Resistor Rated 71 Ohm 3KW Tolerance +/-5%	BKRXLG-3000W-71RJ	Call us
Braking Resistor Rated 15 Ohm 40KW Tolerance +/-5%	BKBRU-BW40KW-15RJ	Call us
Braking Resistor Rated 11 Ohm 50KW Tolerance +/-5%	BKBRU-BW50KW-11RJ	Call us
Braking Resistor Rated 4,2 Ohm 100KW Tolerance +/-5%	BKBRU-BW100KW-4.2RJ	Call us

VARIABLE FREQUENCY DRIVE (VFD)

INVERTER



FV-20 Series

Specification :

- * The cost effective High performance vector variable frequency drive
- * Starting torque : 200% rate torque at 0.0Hz (close-loop flux vector control)
- * Output frequency 0 - 300Hz (>300Hz is customized)
- * Four patten V/F control and Setable V/F curves
- * Built in EMC Filter and built in braking unit ≤ 45kW
- * Standard equipped Modbus (RS485 baud rate up to 125Mbps)
- * Support synchronous motors, servo motors (resolver encoder)
- * Application for : Pump, Fan, Blower, Conveyor, Compressor, Extruder, Injection machine, elevator, Hoist**, Crane**



Input Volatge	Output Voltage	Power Range (kW)	Type	Price (Rp)
1Phase / 220VAC	3 Phase / 220VAC	0,4	FV20-2S-0004G	3.100.000
		0,75	FV20-2S-0007G	3.490.000
		1,5	FV20-2S-0015G	4.081.000
		2,2	FV20-2S-0022G	4.709.000
3 Phase / 220VAC	3 Phase / 220VAC	1,5	FV20-2T-0015G	4.529.000
		2,2	FV20-2T-0022G	4.787.000
		3,7	FV20-2T-0037G	5.156.000
		5,5	FV20-2T-0055G	8.145.000
3 Phase / 380VAC	3 Phase / 380VAC	7,5	FV20-2T-0075G	8.269.000
		0,75	FV20-4T-0007G/0015L	3.422.000
		1,5	FV20-4T-0015G/0022L	3.704.000
		2,2	FV20-4T-0022G/0037L	4.220.000
		3,7	FV20-4T-0037G/0055L	5.088.000
		5,5	FV20-4T-0055G/0075L	6.752.000
		7,5	FV20-4T-0075G/0110L	7.860.000
		11	FV20-4T-0110G/0150L	10.020.000
		15	FV20-4T-0150G/0185L	11.012.000
		18,5	FV20-4T-0185G/0220L	12.599.000
		22	FV20-4T-0220G/0300L	17.993.000
		30	FV20-4T-0300G/0370L	21.906.000
		37	FV20-4T-0370G/0450L	26.936.000
		45	FV20-4T-0450G/0550L	35.214.000
		55	FV20-4T-0550G/0750L	44.585.000
		75	FV20-4T-0750G/0900L	47.982.000
		90	FV20-4T-0900G/1100L	53.774.000
		110	FV20-4T-1100G/1320L	70.592.000
		132	FV20-4T-1320G/1600L	80.827.000
		160	FV20-4T-1600G/1850L	125.748.000
		185	FV20-4T-1850G/2000L	127.874.000
		200	FV20-4T-2000G/2200L	139.949.000
		220	FV20-4T-2200G/2500L	171.234.000
		250	FV20-4T-2500G/2800L	188.249.000
280	FV20-4T-2800G/3150L	230.963.000		
315	FV20-4T-3150G/3550L	281.149.000		
355	FV20-4T-3550G/4000L	294.232.000		
400	FV20-4T-4000G/4500L	328.259.000		

PRICE LIST 2024

HUMAN MACHINE INTERFACE

HMI



Size (Inc)	Type	Description	Price (Rp)
4.3 inch	GL043 / M2043H	16,77M color, TFT display, 480*272 high resolution, 2 COM ports (M2 3 COM ports), 1 USB slave, cutout size 119x93mm	2.180.000
	GL043E / M2043HE	16,77M color, TFT display, 480*272 high resolution, 2 COM ports (M2 3 COM ports), 1 USB slave, 1 Ethernet port, cutout size 119x93mm	2.422.000
	GH043	16,77M color, TFT display, 480*272 high resolution, 2 COM ports, standard 1 USB host, 1 USB slave, built-in isolated power supply, main board coating spray three defense layer, cutout size 146x81mm	4.652.000
	GH043E	16,77M color, TFT display, 480*272 high resolution, 2 COM ports, standard 1 USB host, 1 USB slave, 1 Ethernet port, 1 SD card interface, built-in isolated power supply, main board spray three defense layer, cutout size 146x81mm	4.991.000
7 inch	GL070 / M2070H	16,77M color, TFT display, 800*480 high resolution, 2 COM ports (M2 3 COM ports), standard 1 USB host, 1 USB slave, cutout size 192x138mm	2.422.000
	GL070E / M2070HE	16,77M color, TFT display, 800*480 high resolution, 2 COM ports (M2 3 COM ports), standard 1 USB host, 1 USB slave, 1 Ethernet port, cutout size 192x138mm	2.665.000
	G070	16,77M color, TFT display, 800*480 high resolution, 3 COM ports, standard 1 USB host, 1 USB slave, built-in isolated power supply, cutout size 192x138mm	3.392.000
	G070E	16,77M color, TFT display, 800*480 high resolution, 3 COM ports, standard 1 USB host, 1 USB slave, 1 Ethernet port, built-in isolated power supply, cutout size 192x138mm	3.634.000
	G070E-CAN	16,77M color, TFT display, 800*480 high resolution, 3 COM ports, standard 1 USB host, 1 USB slave, 1 Ethernet port, 1 CAN open port, built-in isolated power supply, cutout size 192x138mm	7.366.000
	GH070	16,77M color, TFT display, 800*480 high resolution, 4 COM ports, standard 1 USB host, 1 USB slave, 1 SD card interface, built-in isolation power supply, cutout size 194x113mm	4.894.000
	GH070E	16,77M color, TFT display, 800*480 high resolution, 4 COM ports, standard 1 USB host, 1 USB slave, 1 Ethernet port. 1 SD card interface, built-in isolation power, serial port isolation, main board coating spray three defense layer, cutout size 194x113mm	7.657.000

HUMAN MACHINE INTERFACE

HMI



Size (Inc)	Type	Description	Price (Rp)
10,1 inch	GL100 / M2100H	16,77M color, TFT display, 1024*600 high resolution, 2 COM ports (M2 3 COM ports), standard 1 USB host, 1 USB slave, cutout size 261x180mm	4.603.000
	GL100E / M2100HE	16,77M color, TFT display, 1024*600 high resolution, 2 COM ports (M2 3 COM ports), standard 1 USB host, 1 USB slave, 1 Ethernet port, cutout size 261x180mm	4.846.000
10,4 inch	GL104E	16,77M color, TFT display, 800*600 high resolution, 2 COM ports, standard 1 USB host, 1 USB slave, 1 Ethernet port, cutout size 299x219mm	9.934.000
	GH104E	16,77M color, TFT display, 800*600 high resolution, 4 COM ports, standard 1 USB host, 1 USB slave, 1 Ethernet port, 1 SD card interface, built-in isolated power supply, serial port isolation, main board coating spray three defense layer, cutout size 299x219mm	18.367.000
15 inch	GL150E	65K color, TFT display, 1024*768 high resolution, 2 COM ports, standard 1 USB host, 1 USB slave, 1 Ethernet port, cutout size 383x283mm	19.384.000
	GH150E	65K color, TFT display, 1024*768 high resolution, 4 COM ports, standard 1 USB host, 1 USB slave, 1 Ethernet port, 1 SD card interface, built-in isolation power, serial port isolation, main board coating spray three defense layer	25.732.000

HMI + PLC



Size (Inc)	Type	Description	Price (Rp)
4,3 inch	HP043-20DT / MK043E-20DT	DC24V power, DI 9*DC24V, DO 9*DC24V, AI 2*V, USB2.0 programming port, 1 RS485 communication port (MK 2 RS485 communication port), can not support expansion modules (MK support, and ethernet), 4,3in, 65K color, TFT display, 480*272 resolution, standard 1 USB host, 1 USB slave, cut out size 119x93mm	3.392.000
	HP043-20DTC / MK043-20DTC	DC24V power, DI 9*DC24V, DO 9*DC24V, AI 2*TC, USB2.0 programming port, 1 RS485 communication port, 4,3in, 65K color, TFT display, 480*272 resolution, standard 1 USB host, 1 USB slave, cut out size 119x93mm	4.846.000
7 inch	HP070-33DT / MK070E-33DT	DC24V power, DI 16*DC24V, DO 14*DC24V, AI 2*IV, AO 1*IV, 1 USB2.0 slave programming port (HMI & PLC sharing), PLC 2 RS485 communication port, support up to 8 KS series expansion modules (MK have ethernet), 7in, 65K color, TFT display, 800*480 resolution, standard 1 USB host, cut out size 192x138mm	5.048.000

PRICE LIST 2024

PROGRAMMABLE LOGIC CONTROLLER PLC



Type	Description			Price (Rp)	
	Input/Output	O/P Type	Model		
K5 Series					
	K504EX-14AR / K604EX-14AR	8DI+6DO	Relay	CPU AC Input power	2.468.000
	K504EX-14AT / K604EX-14AT	8DI+6DO	Transistor	CPU AC Input power	2.468.000
	K504EX-14DR / K604EX-14DR	8DI+6DO	Relay	CPU DC Input power	2.468.000
	K504EX-14DT / K604EX-14DT	8DI+6DO	Transistor	CPU DC Input power	2.468.000
	K506-24AR / K606-24AR	14DI+10DO	Relay	CPU AC Input power	2.783.000
	K506-24AT / K606-24AT	14DI+10DO	Transistor	CPU AC Input power	2.783.000
	K506EA-30AT / K606EA-30AT	14DI+10DO+4AI+2AO	Transistor	CPU AC Input power	4.405.000
	K506EA-30DT / K606EA-30DT	14DI+10DO+4AI+2AO	Transistor	CPU DC Input power	4.405.000
	K506-24DT / K606-24DT	14DI+10DO	Transistor	CPU DC Input power	2.783.000
	K506-24DR / K606-24DR	14DI+10DO	Relay	CPU DC Input power	2.783.000
	K508-40AR / K608-40AR	24DI+16DO	Relay	CPU AC Input power	3.989.000
	K508-40AT / K608-40AT	24DI+16DO	Transistor	CPU AC Input power	3.989.000
	K508-40AX / K608-40AX	24DI+16DO	Relay + Transistor	CPU AC Input power	3.989.000
	K508-40DR / K608-40DR	24DI+16DO	Relay	CPU DC Input power	3.989.000
	K508-40DT / K608-40DT	24DI+16DO	Transistor	CPU DC Input power	3.989.000
K5 Series Expansion					
	K523-08DR	4DI+4DO	Relay	Expansion Digital	998.000
	K523-16DR	8DI+8DO	Relay	Expansion Digital	1.376.000
	K521-08DX	8DI	-	Expansion Digital	1.166.000
	K521-16DX	16DI	-	Expansion Digital	1.670.000
	K522-08DT	8DO	Transistor	Expansion Digital	1.733.000
	K522-16DT	16DO	Transistor	Expansion Digital	2.285.000
	K522-08XR	08DO	Relay	Expansion Digital	1.430.000
	K522-16XR	16DO	Relay	Expansion Digital	2.057.000
	K531-04IV	4AI	Universal AI	Expansion Analog	1.953.000
	K531-04RD	4RTD	RTD	Expansion PT100	2.285.000
	K531-04TC	4TC	TC	Expansion Thermocouple	2.457.000
	K532-02IV	2AO	Universal AO	Expansion Analog	1.994.000
	K533-04IV	2AI+2AO	Universal AIO	Expansion Analog	2.331.000
	K541	CAN OPEN	FIELD BUS	Expansion can PORT	2.258.000
	K580	POWER	Additional	Power	756.000
K2 Series					
	K204ET-16DT	8DI++6DO+1AI+1AO	ETHERNET	CPU DC Input power	3.581.000
	K205-16DT	6DI+4DIO+6DO	Transistor	CPU DC Input power	1.460.000
	K205-16DR	6DI+4DIO+6DO	Relay	CPU DC Input power	1.586.000
	K205EX-22DT	8DI+6DIO+8DO	Transistor	CPU DC Input power	1.911.000
	K205EA-18DT	8DI++8DO+1AI+1AO	Transistor	CPU DC Input power	1.994.000
	K209EA-50DX	22DI+8DOT+12DOR+6AI+2AO	Relay + Transistor	CPU DC Input power	5.072.000
KW Series					
	KW203-12DT-LoRa	8DI SINK+4DIO	CAN OPEN + RS232 + RS485	CPU LORA	3.749.000
	KW213-08DTX-R2	8DIO	RS485	CPU 12VDC / 24VDC LORA	2.909.000
Accessories PLC					
	MT54-K5-2M	Cable download PLC K5 Series/Cable communication HMI to PLC Kinco (2Meter)		84.000	

SERVO MOTORS & DRIVER

SMC Series



Motor Capacity	Description	Type	Specification	Price (Rp)	
100W/3Phase (3000rpm) 220VAC	Servo Motor	SMC40S-0010-30MAK-5LSU	100W 220V 3000RPM 0,32NM 0,033KG.CM², 1,4A-4,2A	4.883.000	10.717.000
	Servo Driver	CD413-AA-000	INPUT 1PHASE 220VAC, RATED 2A, MAX 7A, NO FAN	5.198.000	
	Cable Power Motor	MOT-005-03-KL-Y	RATED CURRENT 5A, LENGTH 3M, Y TYPE TERMINAL CABLE	265.000	
	Cable Encoder	ENCDG-03-GU	LENGTH 3M, 6 CORE CABLE U TYPE PLUG	371.000	
200W/3Phase (3000rpm) 220VAC	Servo Motor	SMC60S-0020-30MAK-3LSU	200W 220V 3000RPM 0,64NM 0,214KG.CM², 1,4A-4,2A	3.339.000	9.488.000
	Servo Driver	CD423-AA-000	INPUT 1PHASE 220VAC, RATED 3,9A, MAX 15A, WITH FAN	5.513.000	
	Cable Power Motor	MOT-005-03-KL-Y	RATED CURRENT 5A, LENGTH 3M, Y TYPE TERMINAL CABLE	265.000	
	Cable Encoder	ENCDG-03-GU	LENGTH 3M, 6 CORE CABLE U TYPE PLUG	371.000	
400W/3Phase (3000rpm) 220VAC	Servo Motor	SMC60S-0040-30MAK-3LSU	400W 220V 3000RPM 1,27NM 0,405KG.CM², 2,4A-7,2A	3.549.000	9.698.000
	Servo Driver	CD423-AA-000	INPUT 1PHASE 220VAC, RATED 3,9A, MAX 15A, WITH FAN	5.513.000	
	Cable Power Motor	MOT-005-03-KL-Y	RATED CURRENT 5A, LENGTH 3M, Y TYPE TERMINAL CABLE	265.000	
	Cable Encoder	ENCDG-03-GU	LENGTH 3M, 6 CORE CABLE U TYPE PLUG	371.000	
750W/3Phase (3000rpm) 220VAC	Servo Motor	SMC80S-0075-30MAK-3LSU	750W 220V 3000RPM 2,39NM 1,087KG.CM², 3,8A-11,4A	4.568.000	10.717.000
	Servo Driver	CD423-AA-000	INPUT 1PHASE 220VAC, RATED 3,9A, MAX 15A, WITH FAN	5.513.000	
	Cable Power Motor	MOT-005-03-KL-Y	RATED CURRENT 5A, LENGTH 3M, Y TYPE TERMINAL CABLE	265.000	
	Cable Encoder	ENCDG-03-GU	LENGTH 3M, 6 CORE CABLE U TYPE PLUG	371.000	
3kW/3Phase (3000rpm) 380VAC	Servo Motor	SMC130D-0300-30AAK-4HKP	3KW 380V 3000RPM 10NM 23,4KG.CM², 6,4A-15,9A	12.705.000	23.916.000
	Servo Driver	CD622S-AA-000	INPUT 3PHASE 380VAC, RATED 7A, MAX 25A, WITH FAN	10.364.000	
	Cable Power Motor	MOT-008-03-KC4	RATED CURRENT 8A, LENGTH 3M, HFO21 TYPE PLUG	635.000	
	Cable Encoder	ENCCA-03-KC0	LENGTH 3M, 16 CORE CABLE, HFO TYPE PLUG	212.000	

PRICE LIST 2024

SERVO MOTORS & DRIVER

SMG Series



Motor Capacity	Description	Type	Specification	Price (Rp)	
1kW/3Phase (1000rpm) 220VAC	Servo Motor	SMG130D-0100-10AAK-4LKG	1KW 220V 1000RPM 10NM 19,4KG.CM², 4,5A-9A	7.243.000	15.380.000
	Servo Driver	CD422S-AF-000	INPUT 1PHASE 220VAC, RATED 4,6A, MAX 15A, WITH FAN	7.237.000	
	Cable Power Motor	MOT-005-03-KG1	RATED CURRENT 5A, LENGTH 3M, YD28 TYPE PLUG	477.000	
	Cable Encoder	ENCCA-03-KG1	LENGTH 3M, 16 CORE CABLE YD28 TYPE PLUG	423.000	
1KW/3Phase (2000rpm) 220VAC	Servo Motor	SMG130D-0100-20AAK-4LKG	1KW 220V 2000RPM 5NM 10,6KG.CM², 5A-12,5A	7.791.000	15.928.000
	Servo Driver	CD422S-AF-000	INPUT 1PHASE 220VAC, RATED 4,6A, MAX 15A, WITH FAN	7.237.000	
	Cable Power Motor	MOT-005-03-KG1	RATED CURRENT 5A, LENGTH 3M, YD28 TYPE PLUG	477.000	
	Cable Encoder	ENCCA-03-KG1	LENGTH 3M, 16 CORE CABLE YD28 TYPE PLUG	423.000	
1.5kW/ 3Phase (2000rpm) 220VAC	Servo Motor	SMG130D-0150-20AAK-4LKG	1,5KW 220V 2000RPM 7,7NM 15,3KG.CM², 7,5A-18,75A	6.510.000	16.073.000
	Servo Driver	CD432S-AA-000	INPUT 1PHASE / 3PHASE 220VAC, RATED 11A, MAX 27,5A, WITH FAN	8.505.000	
	Cable Power Motor	MOT-008-03-KG1	RATED CURRENT 8A, LENGTH 3M, YD28 TYPE PLUG	635.000	
	Cable Encoder	ENCCA-03-KG1	LENGTH 3M, 16 CORE CABLE YD28 TYPE PLUG	423.000	
1.5kW/3Phase (2000rpm) 380VAC	Servo Motor	SMG130D-0150-20AAK-4HKG	1,5KW 380V 2000RPM 7,7NM 15,3KG.CM², 4,7A-11,75A	6.510.000	16.514.000
	Servo Driver	CD612S-AA-000	INPUT 3PHASE 380VAC, RATED 5,5A, MAX 15A, WITH FAN	9.104.000	
	Cable Power Motor	MOT-005-03-KG1	RATED CURRENT 5A, LENGTH 3M, YD28 TYPE PLUG	477.000	
	Cable Encoder	ENCCA-03-KG1	LENGTH 3M, 16 CORE CABLE YD28 TYPE PLUG	423.000	
2kW/3Phase (2000rpm) 220VAC	Servo Motor	SMG130D-0200-20AAK-4LKG	2KW 220V 2000RPM 10NM 19,4KG.CM², 10A-25A	7.875.000	17.491.000
	Servo Driver	CD432S-AA-000	INPUT 1PHASE / 3PHASE 220VAC, RATED 11A, MAX 27,5A, WITH FAN	8.505.000	
	Cable Power Motor	MOT-015-03-KG1	RATED CURRENT 15A, LENGTH 3M, YD28 TYPE PLUG	688.000	
	Cable Encoder	ENCCA-03-KG1	LENGTH 3M, 16 CORE CABLE YD28 TYPE PLUG	423.000	

SERVO MOTORS & DRIVER

SMG Series



Motor Capacity	Description	Type	Specification	Price (Rp)	
2kW/3Phase (2000rpm) 380VAC	Servo Motor	SMG130D-0200-20AAK-4HKG	2KW 380V 2000RPM 10NM 19,4KG.CM ² , 5,9A-14,75A	7.875.000	18.037.000
	Servo Driver	CD612S-AA-000	INPUT 3PHASE 380VAC, RATED 5,5A, MAX 15A, WITH FAN	9.104.000	
	Cable Power Motor	MOT-008-03-KG1	RATED CURRENT 8A, LENGTH 3M, YD28 TYPE PLUG	635.000	
	Cable Encoder	ENCCA-03-KG1	LENGTH 3M, 16 CORE CABLE YD28 TYPE PLUG	423.000	
3kW/3Phase (2000rpm) 380VAC	Servo Motor	SMG130D-0300-20AAK-4HKG	3KW 380V 2000RPM 15NM 27,7KG.CM ² , 7,4A-18,5A	9.104.000	20.526.000
	Servo Driver	CD622S-AA-000	INPUT 3PHASE 380VAC, RATED 7A, MAX 25A, WITH FAN	10.364.000	
	Cable Power Motor	MOT-008-03-KG1	RATED CURRENT 8A, LENGTH 3M, YD28 TYPE PLUG	635.000	
	Cable Encoder	ENCCA-03-KG1	LENGTH 3M, 16 CORE CABLE YD28 TYPE PLUG	423.000	
4.4kW/3Phase (1500rpm) 380VAC	Servo Motor	SMG180D-0440-15AAK-4HKG	4,4KW 380V 1500RPM 27NM 96,4KG.CM ² , 10A-24,81A	18.165.000	38.806.000
	Servo Driver	JD640-LA-000	INPUT 3PHASE 380VAC, RATED 13A, MAX 45A, NO FAN, RS232+RS485	19.530.000	
	Cable Power Motor	MOT-015-03-KG2	RATED CURRENT 15A, LENGTH 3M, YD32 TYPE PLUG	688.000	
	Cable Encoder	ENCCA-03-KG1	LENGTH 3M, 16 CORE CABLE YD28 TYPE PLUG	423.000	
5.5kW/3Phase (1500rpm) 380VAC	Servo Motor	SMG180D-0550-15AAK-4HKG	5,5KW 380V 1500RPM 35NM 122,5KG.CM ² , 12A-30A	20.790.000	41.431.000
	Servo Driver	JD640-LA-000	INPUT 3PHASE 380VAC, RATED 13A, MAX 45A, NO FAN, RS232+RS485	19.530.000	
	Cable Power Motor	MOT-015-03-KG2	RATED CURRENT 15A, LENGTH 3M, YD32 TYPE PLUG	688.000	
	Cable Encoder	ENCCA-03-KG1	LENGTH 3M, 16 CORE CABLE YD28 TYPE PLUG	423.000	
7.5kW/3Phase (1500rpm) 380VAC	Servo Motor	SMG180D-0750-15AAK-4HKG	7,5KW 380V 1500RPM 48NM 167,2KG.CM ² , 20A-50A	23.415.000	60.599.000
	Servo Driver	JD650-AA-000	INPUT 3PHASE 380VAC, RATED 18A, MAX 65A, NO FAN, RS232+RS485+CAN	35.648.000	
	Cable Power Motor	MOT-030-03-KG2	RATED CURRENT 30A, LENGTH 3M, YD32 TYPE PLUG	1.113.000	
	Cable Encoder	ENCCA-03-KG1	LENGTH 3M, 16 CORE CABLE YD28 TYPE PLUG	423.000	

PRICE LIST 2024

selec®

Creating Best Value

MONITORING MANAGEMENT & PROTECTION SOLUTION



POWER ENERGY MANAGEMENT | DIGITAL MULTIMETER | ENERGY METER | DIGITAL PANEL METER

POWER FACTOR CONTROLLER | ANALOG/DIGITAL TIMER | PROTECTION RELAYS

VOLTAGE PROTECTION | CURRENT PROTECTION | PHASE SEQUENCE | WATER LEVEL CONTROLLER

EARTH LAAKAGE | CBCT | TEMPERATURE CONTROL & PROCESS | DIGITAL TEMPERATURE

COLLING CONTROLLER | PROCESS INDICATOR | COUNTER | RPM METER

DIGITAL MULTIFUNCTION METER (Power Meter)



SELEC
Creating Best Value



Function	Description	Type	Size	Price (Rp)
<ul style="list-style-type: none"> • 3Φ (True rms) Voltage • 3Φ (True rms) Current • 3Φ kW, kVA, kVA_r, kWh, kWh_a, kWh_r • 3Φ Power Factor • Frequency • Total Harmonic Distortion • Demand (Min/Max Active Power, Min/Max Reactive Power, Max Apparent Power) • Programmable CT/PT Primary / Secondary • Modbus RTU communication (RS485) • Pulse Output 	<p>3-Phase LCD Multifunction Meter</p> <ul style="list-style-type: none"> > With bargraph of Current > With Communication (RS485) > Input : 3Φ-3W/4W, 2Φ-3W, 1Φ-2W 	MFM384-C	96 X 96	2.100.000
<ul style="list-style-type: none"> • 3Φ (True rms) Voltage • 3Φ (True rms) Current • 3Φ kW, kVA, kVA_r, kWh, kWh_a, kWh_r • 3Φ Power Factor • Frequency • Programmable CT/PT Primary / Secondary • Modbus RTU communication (RS485) • Pulse Output 	<p>3-Phase LCD Multifunction Meter</p> <ul style="list-style-type: none"> > With Communication (RS485) > Input : 3Φ-3W/4W, 2Φ-3W, 1Φ-2W 	MFM383A-C	96 X 96	1.575.000
	<p>3-Phase LCD Multifunction Meter</p> <ul style="list-style-type: none"> > Without Communication (RS485) > Input : 3Φ-3W/4W, 2Φ-3W, 1Φ-2W 	MFM383A	96 X 96	1.333.500
<ul style="list-style-type: none"> • 3Φ (True rms) Voltage • 3Φ (True rms) Current • kW, kVA, kVA_r, kWh, kWh_a, kWh_r • 3Φ Power Factor • Frequency • Demand (Min/Max Active Power, Min/Max Reactive Power, Max Apparent Power) • CT Polarity Error • Single Pulse Output 	<p>3-Phase LED Multifunction Meter</p> <ul style="list-style-type: none"> > Input : 3Φ-3W/4W, 2Φ-3W, 1Φ-2W 	MFM376	96 X 96	1.050.000
<ul style="list-style-type: none"> • 3Φ Power (Active, Reactive) • 3Φ Power Factor • 3Φ kW, kVA, kVA_r, kWh, kWh_a, kWh_r • Programmable CT/PT Primary / Secondary • Modbus RTU communication (RS485) 	<p>3-Phase LCD Energy Meter</p> <ul style="list-style-type: none"> > Input : 3Φ-3W/4W, 2Φ-3W, 1Φ-2W 	EM368-C-CU	96 X 96	1.995.000

PRICE LIST 2024

DIGITAL MULTIFUNCTION METER



SELEC
Creating Best Value











Function	Description	Type	Size	Price (Rp)
<ul style="list-style-type: none"> • 3Φ (True rms) Voltage • 3Φ (True rms) Current • Frequency (HZ) • Run Hour (hour meter) • RPM • Programmable CT Primary • Programmable PT Primary & PT Secondary 	<p>3-Phase LCD (V, A, Hz) Meter</p> <ul style="list-style-type: none"> > With bargraph of Current > Input : 3Φ-3W/4W, 2Φ-3W, 1Φ-2W 	VAF36A	96 X 96	997.500
<ul style="list-style-type: none"> • 3Φ (True rms) Voltage • 3Φ (True rms) Current • Frequency (HZ) • Run Hour (hour meter) • RPM • Programmable CT Primary • Programmable PT Primary & PT Secondary 	<p>3-Phase LED (V, A, Hz) Meter</p> <ul style="list-style-type: none"> > Input : 3Φ-3W/4W, 2Φ-3W, 1Φ-2W 	VAF39A-1	96 X 96	619.500
<ul style="list-style-type: none"> • 3Φ (True rms) Voltage • 3Φ (True rms) Current • Frequency (HZ) • 3Φ Power Factor • 3Φ Power (Active, Reactive) • Programmable CT & PT 	<p>3-Phase LED Multifunction Meter</p> <ul style="list-style-type: none"> > Input : 3Φ-3W/4W, 2Φ-3W, 1Φ-2W 	MFM-391	96 X 96	556.500
<ul style="list-style-type: none"> • True rms Voltage • True rms Current • Frequency (HZ) • Power Factor • Power (Active, Reactive) • Programmable CT & PT • Modbus RTU communication (RS485) 	<p>1-Phase LED Multifunction Meter</p> <ul style="list-style-type: none"> with Relay Output > Input : 1Φ - 2wire > Output : 1 Relay / SPST (5A/230VAC) 	MX-300-1-C	96 X 96	630.000

DIGITAL AC METER

(Volt & Ampere)



SELEC®
Creating Best Value

	Description	Type	Size	Price (Rp)
	LCD Ampere Meter, 1Phase 2 Wire > With analog style bargraph Indication > For 1 phase 2 wire connection > For 3 phase with selector swith connection > Input : 1Φ - 2wire	MA201	72 X 72	441.000
		MA301	96 X 96 (with adapter Plate)	441.000
	LCD Ampere Meter, 3Phase 4 wire > With analog style bargraph Indication > For 3 phase 4wire connection > Input : 3Φ - 4 wire / 3Φ - 3 wire > Inbuilt keypad for selection switch	MA2301	72 X 72	525.000
		MA3301	96 X 96 (with adapter Plate)	525.000
	LED Ampere Meter, 1Phase 2 Wire > For 1 phase 2 wire connection > For 3 phase with selector swith connection > Input : 1Φ - 2wire	MA302	96 X 96	231.000
		MA202	72 X 72	
		MA12	48 X 96	
	LED Ampere Meter, 3Phase 4 wire > Input : 3Φ-3W/4W or 1Φ-2W > Inbuilt keypad for selection switch	MA335	96 X 96	420.000
	LCD Volt Meter, 1Phase 2 Wire > With analog style bargraph Indication > For 1 phase 2 wire connection > For 3 phase with selector swith connection > Input : 1Φ - 2wire	MV207	72 X 72	441.000
		MV307	96 X 96 (with adapter Plate)	441.000
	LCD Volt Meter, 3Phase 4 wire > With analog style bargraph Indication > For 3 phase 4wire connection > Input : 3Φ - 4 wire / 3Φ - 3 wire > Inbuilt keypad for selection switch	MV2307	72 X 72	525.000
		MV3307	96 X 96 (with adapter Plate)	525.000
	LED Volt Meter, 1Phase 2 Wire > For 1 phase 2 wire connection > For 3 phase with selector swith connection > Input : 1Φ - 2wire	MV305	96 X 96	231.000
		MV205	72 X 72	
		MV15	48 X 96	
	LED Volt Meter, 3Phase 4 wire > Input : 3Φ-3W/4W or 1Φ-2W > Inbuilt keypad for selection switch	MV334	96 X 96	420.000

PRICE LIST 2024



Digital DC Meter



Description	Type	Size	Price (Rp)
LED Volt Meter, 1Phase 2 Wire > For 1 phase 2 wire connection > For 3 phase with selector swicth connection > Input : 1Φ - 2wire > Range maximum 200VDC	MV305-VDC	96 X 96	525.000
	MV15-VDC	48 X 96	
LED Ampere Meter, 1Phase 2 Wire > For 1 phase 2 wire connection > For 3 phase with selector swicth connection > Input : 1Φ - 2wire > By Shunt Setting (5 - 4000A), 75mV	MA302-VDC	96 X 96	441.000
	MA12-VDC	48 X 96	

Digital Frequency Meter



Description	Type	Size	Price (Rp)
LED Hz Meter, 1Phase 2 Wire > For 1 phase 2 wire connection > Input : 1Φ - 2wire	MF316	96 X 96	430.000
	MF216	72 X 72	
	MF16	48 X 96	

Digital Power Factor Meter



Description	Type	Size	Price (Rp)
LED Power factor Meter / COS Φ > For 1 phase 2 wire connection > Input : 1Φ - 2wire	MP314	96 X 96	535.500

Digital Kwh Meter



Description	Type	Size	Price (Rp)
LED KWh Meter • Energi Active (KWh), 1Phase & 3Phase • Pluse Output • Programmable CT Primery / Secondary	EM306-A	96 X 96	945.000



Power Factor Controller



Description	Steps	Type	Size	Price (Rp)
Power Factor Controller > LED display, 4 digits > Single CT sensing > Automatic program	8	APFC347-108	96 X 96	2.047.500
	8	APFC147-108	144 X 144	2.283.750
	12	APFC147-112	144 X 144	2.751.000
Power Factor Controller > LCD display with dual color backlight > 3 CT sensing > Alarm linked signal contact > Programmable Fan control > MODBUS RTU Communication > Built In VAF meter > Automatic program	8	APFC148-308	144 X 144	5.145.000
	12	APFC148-312	144 X 144	6.027.000

Water Level Controller



Description	Type	Price (Rp)
Water Level Control > Operating Voltage : 85 - 270VAC, 50/60Hz > Output contact : 1 C/O (SPDT) > Used for drain and fill control > For 1 & 2 water tank > Size : 35 X 90mm	WLCA2M2	598.500

Phase Protection Relays

Din-Rail Mounting



SELEC
Creating Best Value



Description	Function	Type	Price (Rp)
<p>Analog Phase Sequence Relay</p> <ul style="list-style-type: none"> > Input connection : 3Φ/3Wire > Operating Voltage : 154 to 500VAC (L - L) , 50/60Hz > Output contact : 1 C/O (SPDT) rating : NO/5A, NC/3A, 250VAC > Power On Delay : 200 msec > Trip time delay : 200 msec max. > Accuracy : Trip ±10V > Size : 22.5 X 76.85mm 	<ul style="list-style-type: none"> • Protection : <ul style="list-style-type: none"> > Phase sequence / reverse > Phase failure > Phase asymmetry / Imbalance > Reset : Auto 	800PSR	219.500
<p>Analog Phase Sequence Relay</p> <ul style="list-style-type: none"> > Input connection : 3Φ/3Wire > Operating Voltage : 154 to 500VAC (L - L) , 50/60Hz > Output contact : 1 C/O (SPDT) rating : NO/5A, NC/3A, 250VAC > Power On Delay : 200 msec > Trip time delay : 0.2 to 10sec > Accuracy : Trip ±10V > Size : 17.5 X 90mm 	<ul style="list-style-type: none"> • Protection : <ul style="list-style-type: none"> > Phase sequence / reverse > Phase failure > Phase asymmetry / Imbalance > Reset : Auto 	600PSR	367.500
<p>Analog Phase Sequence Relay</p> <ul style="list-style-type: none"> > Input connection : 3Φ/3Wire > Operating Voltage : 230VAC ±20% , 50/60Hz > Output contact : 1 C/O (SPDT) rating : NO/5A, 250VAC > Power On Delay : < 500 msec > Trip time delay : 3.5sec > Recovery time delay : <ul style="list-style-type: none"> • phase failure & asymmetry : < 120ms • phase sequence : < 250ms > Accuracy : Trip setting ±1% of F.S Time setting ±5% of F.S > Size : 35 X 90mm 	<ul style="list-style-type: none"> • Protection : <ul style="list-style-type: none"> > Phase sequence / reverse > Phase failure > Phase asymmetry / Imbalance > Reset : Auto 	PSR1	456.800
<p>Analog Phase Sequence Relay</p> <ul style="list-style-type: none"> > Input connection : 3Φ/3Wire > Operating Voltage : 230VAC ±20% , 50/60Hz 415VAC ±20% , 50/60Hz > Output contact : 2 C/O (DPDT) rating : NO/5A, NC/3A, 250VAC > Power On Delay : < 500 msec > Trip time delay : 3.5sec > Recovery time delay : <ul style="list-style-type: none"> • phase failure & asymmetry : < 120ms • phase sequence : < 250ms > Accuracy : Trip setting ±1% of F.S Time setting ±5% of F.S > Size : 52.5 X 90mm 	<ul style="list-style-type: none"> • Protection : <ul style="list-style-type: none"> > Phase sequence / reverse > Phase failure > Phase asymmetry : 30 - 70V > Reset : auto/manual mode 	PSR2	636.000

VOLTAGE PROTECTION RELAYS

Din-Rail Mounting



SELEC
Creating Best Value



Description	Function	Type	Price (Rp)
<p>Analog Voltage Protection Relay</p> <ul style="list-style-type: none"> > Input connection : 3Φ/3Wire > Operating Voltage : 310 to 520VAC (L - L) , 50/60Hz > Output contact : 1 C/O (SPDT) rating : NO/5A, NC/3A, 250VAC > Trip setting : <ul style="list-style-type: none"> • Under voltage trip : -2.5% to -25% of 415VAC • Over voltage trip : -2.5% to -25% of 415VAC > Trip time setting : <ul style="list-style-type: none"> • Power On Delay : 400 msec • Trip time delay : 0.2 to 10sec > Accuracy : Trip setting ±5% of F.S Time setting ±5%of F.S > Size : 17.5 X 90mm 	<ul style="list-style-type: none"> • Protection : <ul style="list-style-type: none"> > Under voltage > Over voltage > Phase sequence / reverse > Phase failure > Phase asymmetry / Imbalance > Reset : Auto 	600VPR	525.000
<p>Analog Voltage Protection Relay</p> <ul style="list-style-type: none"> > Input connection : 3Φ/4Wire, 1Φ/2wire > Operating Voltage : 127 to 288VAC (L-N) , 50/60Hz > Output contact : 2 C/O (DPDT) rating : 5A, 250VAC / 28VDC > Trip setting : <ul style="list-style-type: none"> • Under voltage: 55-95% of Un 127 to 219VAC (L-N) • Over voltage: 105-125% of Un 242 to 288VAC (L-N) • Phase asymmetry : >10% > Trip time setting : <ul style="list-style-type: none"> • Power On Delay : 0-15sec • Trip time delay : 0-15sec • Recovery time delay : 5s ± 200ms <ul style="list-style-type: none"> • L1/neutral loss trip delay : <250ms • phase sequence trip delay : < 250ms > Accuracy : Trip setting ±5% of F.S Time setting ±5%of F.S > Size : 35 X 90mm 	<ul style="list-style-type: none"> • Protection : <ul style="list-style-type: none"> > Under voltage > Over voltage > Phase sequence / reverse > Phase failure > Neutral loss detection > Phase asymmetry 	VPRA2M	475.000
<p>Digital Voltage Protection Relay</p> <ul style="list-style-type: none"> > Input connection : 3Φ/4Wire, 3Φ/3wire > Operating Voltage : 160 to 300VAC (L-N), 280 to 520 (L-L), 50/60Hz > Output contact : 2 x 1 C/O (SPDT) rating : NO/5A, NC/3A, 250VAC > Trip setting : <ul style="list-style-type: none"> • Under / Over voltage : 280 to 520VAC L-L (for 3Φ/3wire system) 160 to 300VAC L-N (for 3Φ/4wire system) • Under / Over Frequency : 45 - 65Hz • Phase asymmetry : 5 - 99.9% > Trip time setting : <ul style="list-style-type: none"> • Power On Delay : 2 - 99.9sec • Trip time delay : 0 - 99.9sec • Recovery time delay : 0 - 99.9sec • Response time : < 200ms > Accuracy : Voltage : ±1% of set value. Frequency : ±0.3Hz > Accuracy time (recovery time, trip delay, power on delay) : ±5% of setting ±200ms > Size : 35 X 90mm 	<ul style="list-style-type: none"> • Protection : <ul style="list-style-type: none"> > Under voltage > Over voltage > Under frequency > Over frequency > Phase sequence / reverse > Phase failure > Phase asymmetry • Monitoring in 3Φ system • True RMS measurement • Power ON delay • Trip time delay • Recovery time delay • Adjustable switching hysteresis • Two separate alarm relays 	900VPR-2	695.000

PRICE LIST 2024

CURRENT PROTECTION RELAYS

Din-Rail Mounting



SELEC
Creating Best Value



Description	Function	Type	Price (Rp)
<p>Digital Current Protection Relay</p> <ul style="list-style-type: none"> > Input connection :1Φ/2wire, with CT > Operating Voltage : 230VAC > Output contact : 1 x 1 C/O (SPDT) rating : NO/5A, NC/3A, 250VAC > Trip setting : <ul style="list-style-type: none"> • Under current : 0 - 999A • Over current : 0.5 - 1.19kA > Trip time setting : <ul style="list-style-type: none"> • Power On Delay : 0 - 99.9s • Trip time delay : 0 - 99.9s • Recovery time delay :0 - 99.9s • Response time : < 200ms > Accuracy : <ul style="list-style-type: none"> • Current : ±1% of setting 2 digits • Time (recovery time, trip delay, power on delay) : ±5% of setting 2 digits > Size : 35 X 90mm 	<ul style="list-style-type: none"> • Protection : <ul style="list-style-type: none"> > Under current > Over current • Monitoring in 1Φ system • True RMS measurement • Power ON delay • Trip time delay • Recovery time delay • Adjustable switching hysteresis • One alarm relays with NC/NC 	900CPR-1	829.500
<p>Digital Current Protection Relay</p> <ul style="list-style-type: none"> > Input connection : 3Φ/4Wire, 3Φ/3Wire, 1Φ/2wire, with CT > Operating Voltage : 230VAC / 110VAC > Output contact : 1 x 1 C/O (SPDT) rating : NO/5A, NC/3A, 250VAC > Trip setting : <ul style="list-style-type: none"> • Under current : 0 - 999A • Over current : 0.5 - 1.19kA • Current asymmetry : 5 - 99.9% > Trip time setting : <ul style="list-style-type: none"> • Power On Delay : 0 - 99.9s • Trip time delay : 0 - 99.9s • Recovery time delay :0 - 99.9s • Response time : < 200ms > Accuracy : <ul style="list-style-type: none"> • Current : ±1% of setting 2 digits • Time (recovery time, trip delay, power on delay) : ±5% of setting 2 digits > Size : 35 X 90mm 	<ul style="list-style-type: none"> • Protection : <ul style="list-style-type: none"> > Under current > Over current > Asymmetry current for 3Φ • Monitoring in 1Φ and 3Φ system • True RMS measurement • Power ON delay • Trip time delay • Recovery time delay • Adjustable switching hysteresis • One alarm relays with NC/NC 	900CPR-3	976.500

EARTH LEAKAGE PROTECTION RELAYS

Din-Rail Mounting



SELEC
Creating Best Value



Description	Function	Type	Price (Rp)
<p>Analog Earth Leakage Relay</p> <ul style="list-style-type: none"> > Input connection : 3Φ/4Wire & 1Φ/2wire > Operating Voltage : 230VAC, 50/60Hz > Sensitivity (ΔI) & Time Delay (Δt) adjustable > Trip setting : <ul style="list-style-type: none"> • Leakage current : 30mA - 30A > Size : 35 X 90mm 	<ul style="list-style-type: none"> • Protection earth leakage current • Leakage current monitoring in 1Φ and 3Φ system • CBCT open circuit indication • Test and reset function 	ELRA2M2	900.000
<p>Digital Earth Leakage Relay</p> <ul style="list-style-type: none"> > Input connection : 3Φ/4Wire, 3Φ/3Wire, 1Φ/2wire > Operating Voltage : 230VAC / 110VAC > Output contact : 2 x 1 C/O (SPDT) rating : NO/5A, NC/3A, 250VAC > Trip setting : <ul style="list-style-type: none"> • Leakage current : 10mA - 30A • Pre alarm : 50 - 100% of leakage current setting > Trip time setting : <ul style="list-style-type: none"> • Power On Delay : 0.5 - 99.9s • Trip time delay : 0 - 99.9s • Recovery time delay : 0 - 99.9s > Response time : <ul style="list-style-type: none"> < 30ms (if trip current ≥ 5 x set value) < 50ms (if trip current ≥ 1 x set value) > Accuracy : <ul style="list-style-type: none"> • Current : ±5% of setting 2 digits • Time delays : ±5% of setting ±100ms > Size : 35 X 90mm 	<ul style="list-style-type: none"> • Protection earth leakage current • Leakage current monitoring in 1Φ and 3Φ system • True RMS measurement • CBCT connection monitoring • Power ON delay • Trip time delay • Recovery time delay • Adjustable switching hysteresis • Test and reset via front / remote • Two separate alarm relays with NC/NC 	900ERL-2	1.155.000
<p>Analog Earth Leakage Relay</p> <ul style="list-style-type: none"> > Input connection : 3Φ/4Wire, 3Φ/3Wire, 1Φ/2wire > Operating Voltage : 230VAC, 50/60Hz > Trip setting : <ul style="list-style-type: none"> • Leakage current : 75% of 30mA or 300mA > Size : 74 X 105mm 	<ul style="list-style-type: none"> • Protection earth leakage current • Monitors true RMS earth fault current • Inbuilt CBCT • Test and reset function 	ELCTR35-30mA	577.500
		ELCTR35-300mA	



Zero CT For Earth Leakage Relay (CBCT)



Size (Inner diameter)	Type	CT RATIO	Price (Rp)
35mm	CBCT-35-1	1000:1	273.000
70mm	CBCT-70-1	1000:1	383.000
120mm	CBCT-120-1	1000:1	997.000
210mm	CBCT-210-1	1000:1	1.848.000
310mm	CBCT-310-1	1000:1	2.667.000

PRICE LIST 2024

ANALOG TIMERS

Din-Rail Mounting



SELEC
Creating Best Value



Description	Type	Price (Rp)
<ul style="list-style-type: none"> • 13 Function, 10 time range • Modes : A, B, C, Ci, D, E, F, H, I, J, K, Ai, Bi • Time range : 0.1-1s, 0.3-3s, 1-10s, 3-30s, 0.1-1m, 0.3-3m, 1-10m, 3-30m, 0.1-1hr, 0.3-3hr • Output contact : 1 C/O (SPDT) rating : NO/5A, NC/3A, 250VAC • Input voltage : 20-240VAC / 12-240VDC, 50/60Hz • Size : 17.5 X 90 X 60mm 	600XU	505.000
<ul style="list-style-type: none"> • Single Function, 10 time range • Modes : On Delay • Time range : 0.1-1s, 0.3-3s, 1-10s, 3-30s, 0.1-1m, 0.3-3m, 1-10m, 3-30m, 0.1-1hr, 0.3-3hr • Output contact : 1 C/O (SPDT) rating : NO/5A, NC/3A, 250VAC • Input voltage : 240VAC, 50/60Hz • Size : 17.5 X 90 X 60mm 	600ST	367.000
<ul style="list-style-type: none"> • 2 Function, 12 time range, Universal voltage • Modes : On Delay / Interval • Time range : 1 / 3 / 10 / 30 sec / min / hr • Output contact : 2 C/O (DPDT) • Input voltage : 20-240VAC / 12-240VDC, 50/60Hz • Size : 22.5 X 75 X 101mm 	800XU	512.000
<ul style="list-style-type: none"> • 2 Function, 8 time range, Universal voltage • Modes : On Delay / Interval • Time range : 3 / 10 / 30 / 60 sec / min • Output contact : 2 C/O (DPDT) • Input voltage : 20-240VAC / 12-240VDC, 50/60Hz • Size : 22.5 X 75 X 101mm 	800XA	393.000
<ul style="list-style-type: none"> • 2 Function, 8 time range, dual voltage • Modes : On Delay / Interval • Time range : 3 / 10 / 30 / 60 sec / min • Output contact : 1 C/O (SPDT) • Input voltage : 230-230VAC & 24VAC/DC, 50/60Hz • Size : 22.5 X 75 X 101mm 	800SQ-A	294.000

Modes : **A** (On delay), **B** (Interval), **C** (Repeat Cycle Equal OFF first), **Ci** (Repeat Cycle Equal ON first), **D** (Pulse Output 500ms fixed), **E** (Delay on break), **F** (Delay on make/Delay on break), **H** (Interval after break), **I** (Single short), **J** (Retriggerable single short), **K** (Latching relay), **Ai** (Delay on make with totalise), **Bi** (Interval with totalise).



ANALOG TIMERS

Din-Rail Mounting



Description	Type	Price (Rp)
<ul style="list-style-type: none"> Single Function, Single time range Modes : On delay Time range : 30sec and 60sec Output contact : 1 C/O (SPDT) Input voltage : 230VAC/50Hz Size : 22.5 X 75 X 101mm 	800S - 60S (60sec)	275.000
<ul style="list-style-type: none"> Single Function, Single time range Modes : True power OFF delay Time range : 60sec and 180sec Output contact : 2 C/O (DPDT) Input voltage : 110 - 240VAC/DC, 50/60Hz Size : 22.5 X 75 X 101mm 	800POD - 60S (60sec)	972.000
	800POD - 180S (180sec)	972.000
<ul style="list-style-type: none"> Cyclic with unequal ON & OFF time Modes : Asymmetrical cyclic ON first or OFF first Time range : 1 / 10 /sec/min/hr for both ON & OFF time Output contact : 2 C/O (DPDT) Input voltage : 20-240VAC / 12-240VDC, 50Hz Size : 22.5 X 75 X 101mm 	800XC	567.000
<ul style="list-style-type: none"> Function for Forward - Pause - Reverse Modes : Forward - Pause - Reverse Time range : ON time : 1/2/4/8 min Pause time : 10/20/40/80 Sec Output contact : 1 C/O each for forward & Reverse Input voltage : 20-240VAC / 12-240VDC, 50/60Hz Size : 22.5 X 75 X 101mm 	800XMR	650.000
<ul style="list-style-type: none"> Function for Star - Delta timer Modes : Star - Delta Time range : Run up time range : 30/60 sec Change over time : 50/100 sec Output contact : 1 C/O relay each for star - delta Input voltage : 230VAC, 50HZ Size : 22.5 X 75 X 101mm 	800SD-2	357.000



ANALOG TIMERS

Pin-Plug Mounting



Description	Type	Price (Rp)
<ul style="list-style-type: none"> • 2 Function, 12 time range, Universal voltage • Modes : On delay / Interval • Time range : 1 / 3 / 10 / 30 sec / min / hr • Output contact : 2 C/O (DPDT) • Input voltage : 20-240VAC / 12-240VDC, 50/60Hz • Size : 48 X 48mm 	55XU-P8	510.000
<ul style="list-style-type: none"> • 2 Function, 8 time range, dual voltage • Modes : On Delay / Interval • Time range : 3 / 10 / 30 / 60 sec / min • Output contact : 1 C/O (SPDT) • Input voltage : 230-230VAC & 24VAC/DC, 50/60Hz • Size : 48 X 48mm 	55ES-P8	300.000
<ul style="list-style-type: none"> • 2 Function, 8 time range • Modes : On Delay / Interval • Time range : 3 / 10 / 30 / 60 sec / min • Output contact : 2 C/O (DPDT) • Input voltage : 230VAC/ 50Hz • Size : 48 X 48mm 	55Q-P8	375.000

DIGITAL TIMERS

Digital Timer (Panel Mounting)



Description	Type	Price (Rp)
<ul style="list-style-type: none"> • 2 Function, 3 digits LED • Modes : On delay / Interval • Time range : 9.99/99.9/999sec, 99.9/999min, 99,9hr • Output contact : 2 C/O (DPDT) • Input voltage : 97 - 270V AC/DC, 50/60Hz • Size : 48 X 48mm 	XT56N	1.000.000
<ul style="list-style-type: none"> • 4 Function, 3 digits LED • Modes : On delay / Interval / Cyclic ON or OFF first • Time range : 9.99/99.9/999sec, 9.59min : sec, 99.9/999min, 9.59hr : min, 99.9/999hr • Output contact : 2 C/O (DPDT) • Input voltage : 85 - 270V AC/DC, 50/60Hz • Size : 48 X 48mm 	XT546	800.000

WEEKLY TIMERS



Description	Type	Price (Rp)
<p>Weekly timer</p> <ul style="list-style-type: none"> > Operating Voltage : 220VAC, 50/60Hz > Output contact : 1 C/O (SPDT) > Contact Rating : 16A / 250VAC > 50 ON - OFF Step per day > Size : 35 X 90mm 	TS2M1-1	480.000

COUNTER & RATE INDICATORS



SELEC
Creating Best Value



Description	Size	Type	Price (Rp)
<ul style="list-style-type: none"> • Time Totaliser • LCD display , 8 digits • Time range : 999999.99 hr • Input Type : a) 24 - 260 VAC b) Contact • Input voltage : battery powered 	48 X 48	LT945V (Voltage Input)	340.000
		LT945C (Contact Input)	340.000
<ul style="list-style-type: none"> • RPM Meters • LED display , 4 digits • Range : 4.00 to 9999 RPM • Input Speed : 4 to 9999 pulses per minute • Input Type : Voltage plus 3 - 30VDC • Input voltage : 90 - 270 V AC/DC • Sensor type : PNP / NPN 	48 X 48	RC5100 (sensor PNP)	830.000
	72 X 72	RC2100 (sensor PNP/NPN)	830.000
	48 X 96	RC100 (sensor PNP)	900.000
<ul style="list-style-type: none"> • Counter & Totaliser • LED display , 6 digits • Range : 999999 counts • Input Speed : a) 0 to 20Hz, b) 0 to 1kHz • Input Type : Voltage plus 3 - 30VDC • Input voltage : 90 - 270 V AC/DC, 24VAC/DC • Sensor type : PNP, NPN 	36 X 72	XC410	740.000
<ul style="list-style-type: none"> • Counter • LCD display , 8 digits • Range : 99999999 counts • Input Speed : a) 14Hz, b) 100Hz • Input Type : 24 - 260 VAC • Input voltage : battery powered 	24 X 48	LXC900V	338.000
<ul style="list-style-type: none"> • Counter with setpoint • LCD display , 4 digits • Modes : On delay / Interval delay / Auto reset • Range : 9999 counts • Input Speed : a) 0 - 30Hz, b) 0 - 5kHz • Input Type : Voltage plus 3 - 30VDC • Input voltage : 230VAC, 50Hz • Sensor type : PNP, NPN • Output contact : 2 C/O (DPDT) 	72 X 72	XC22B-4	1.280.000

DIGITAL TEMPERATURE CONTROLS



SELEC
Creating Best Value



Description	Type	Price (Rp)
<ul style="list-style-type: none"> • LED Single display , 3 digits • Single set point • Control Modes : Auto tune /self tune PID or ON-OFF • Input sensor type : <ul style="list-style-type: none"> > Thermocouple (J,K,T,R,S) > RTD (PT100) • Output Control : Relay / SSR • Input voltage : 85 - 270 V AC/DC, 50/60Hz • Size : 48 X 48 X 76mm 	TC513BX	500.000
<ul style="list-style-type: none"> • LED Dual display , 3 digits • Single set point • Control Modes : Auto tune /self tune PID or ON-OFF • Input sensor type : <ul style="list-style-type: none"> > Thermocouple (J,K,T,R,S) > RTD (PT100) • Output Control : Relay / SSR • Input voltage : 85 - 270 V AC/DC • Size : 48 X 48 X 76mm 	TC533BX	580.000
<ul style="list-style-type: none"> • LED Dual display , 4 digits • Dual set point • Special functions : Heat-Cool PID, Dwell timer • Control Modes : Auto tune /self tune PID or ON-OFF • Input sensor type : <ul style="list-style-type: none"> > Thermocouple (J,K,T,R,S) > RTD (PT100) • Output Control : Relay / SSR • Auxiliary output : 1 (Relay) • Alarm modes : Deviation, absolute • Input voltage : 85 - 270 V AC/DC, 50/60Hz • Size : 48 X 48 X 76mm 	TC544B	780.000
<ul style="list-style-type: none"> • LED Dual display , 4 digits • Single set point • Control Modes : Auto tune /self tune PID or ON-OFF • Input sensor type : <ul style="list-style-type: none"> > Thermocouple (J,K,T,R,S) > RTD (PT100) • Output Control : Relay / SSR • Input voltage : 85 - 270 V AC/DC, 50/60Hz • Size : 48 X 48 X 76mm 	TC538BX	612.000



Digital Temperature Controls



PID500
(size : 48X48X110)



PID110
(size : 48X96X85)

Description	Type	Output	Price (Rp)
<ul style="list-style-type: none"> Advanced PID controller, Covers most applications LED Dual display , 4 digits Fuatures : <ul style="list-style-type: none"> Universal input, Auto tune, Selectable lower display, Single point ramp-soak, Heat-Cool PID, Soft start, Auto/Manual mode Input sensor type : <ul style="list-style-type: none"> Thermocouple (J,K,T,R,S,C,E,B,N,L,U,W) RTD (PT100) Singnal Input (DC) : -5 to 56mV, 0 - 10V, 0 - 20mA Output Control : <ul style="list-style-type: none"> Relay or SSR Current : 0/4 to 20mA (max load 500E) Voltage : 0 - 50/10VDC (max load 10K) Auxiliary output : 2 (Relay or SSR drive voltage) Mode : Set poit or Alarm mode Alarm modes : Deviation, Absolute, Hight, Low, Band ,Sensor break Control action : PID or ON-OFF Input voltage : 85 - 270 V AC/DC, 50/60Hz 	PID500-0-0-00	Out 1 : relay Out 2 : relay	1.580.000
	PID500-1-0-00	Out 1 : SSR Out 2 : relay	1.580.000
	PID500-2-0-00	Out 1 : 4-20mA Out 2 : relay	1.800.000
	PID500-3-0-00	Out 1 : 0-10V Out 2 : relay	1.800.000
	PID110-0-0-00	Out 1 : relay Out 2 : relay	1.740.000
	PID110-1-0-00	Out 1 : SSR Out 2 : relay	1.740.000
	PID110-2-0-00	Out 1 : 4-20mA Out 2 : relay	1.900.000
	PID110-3-0-00	Out 1 : 0-10V Out 2 : relay	1.900.000

Cooling Controllers



Description	Type	Price (Rp)
<ul style="list-style-type: none"> Chiller Controller, Deforst management, Hight & Low alarm LED Single display , 3 digits Display offset : -19.9 to 20.0 °C/F Single set point Control Modes : ON-OFF Input sensor type : NTC Output Control : Relay Alarm output : 2 (Relay or SSR) Input voltage : 85 - 270 V AC/DC, 50/60Hz Relay action : Heat & Cool mode Size : 36 X 72mm 	CH403-1	420.000

Process Indicators



Description	Size	Type	Price (Rp)
Input Voltage (0-10V) & Current (0-20mA)	48 X 96	PIC101A-VI	520.000
Universal input (Thermocouple, Voltage & Current)	48 X 96	PIC101-N	860.000
Universal input (Thermocouple, Voltage & Current) Output 2Alarm : SPDT 5Ampere, Retransmission	48 X 96	PIC152A-VI	1.450.000

YOUR PANEL SOLUTION

Satisfy Every Customers By Our Professional Spirit



NEW PRODUCT 2025

V.4



CABLE WIRING



Description :

- * Kabel NYAF FORT standard SNI (SNI 04-6629.3)
- * Material Conductor : Round Flexible Annealed Copper Wire (f), Class 5 IEC 60228
- * Material Insulation : Polyvinyl Chloride (PVC)
- * Rate Voltage :
 - > Ukuran 0.75 - 1.0mm : 300/500V , standard IEC-06 (60227)
 - > Ukuran 1.5 - 35mm : 450/750V , standard IEC-02 (60227)
- * Test Voltage : 2.5kV / 5Min
- * Max. Conductor Temperature : 70°C
- * Made In Indonesia
- * Bersertifikat :  Kementerian Perindustrian

Deskripsi	Ukuran (mm)	Type	Warna	Packing	Harga/Meter (Rp)
Kabel NYAF 	0.75	NYAF-0.75	Hitam, Merah, Kuning, Biru, Kuning-Hijau, Abu2, Coklat	100M/Roll	2,500
	1.0	NYAF-1.0			3,300
	1.5	NYAF-1.5			4,500
	2.5	NYAF-2.5			7,650
	4	NYAF-4.0	Hitam, Merah, Kuning, Biru, Kuning-Hijau		11,600
	6	NYAF-6.0			18,500
	10	NYAF-10			30,000
	16	NYAF-16	Hitam, Kuning-Hijau		45,500
	25	NYAF-25	Hitam	50M/Roll	69,100
	35	NYAF-35	Hitam		95,500
50	NYAF-50	Hitam	137,100		
75	NYAF-70	Hitam	195,000		

Note :

- * Harga diatas adalah Netto tanpa diskon.
- * Harga dapat berubah sewaktu-waktu mengikuti harga LME global.
- * Minimum order :
 - > Ukuran 0.75 - 16mm per 1 Roll
 - > Ukuran 25 - 35mm per Meter

AC DIGITAL METERING



Description	Type	Price (Rp)
<p>1-Phase AC LED Digital Ampere Meter</p>  <ul style="list-style-type: none"> * 1Phase/2wire * Ampere range : 0-9999/5A * Operating power : 200-240VAC * Class : 0.5 * Size 96x96, 72x72, 48x96 	FCN300-A1	230,000
<p>3-Phase AC LED Digital Ampere Meter</p>  <ul style="list-style-type: none"> * 3Phase/4wire * Ampere range : 0-9999/5A * Operating power : 200-240VAC * Class : 0.5 * Size 96x96, 72x72 	FCN300-A3	420,000
<p>1-Phase AC LED Digital Volt Meter</p>  <ul style="list-style-type: none"> * 1Phase/2wire * Voltage range : 450VAC (L-N) * Operating power : 200-240VAC * Class : 0.5 * Size 96x96, 72x72, 48x96 	FCN300-V1	230,000
<p>3-Phase AC LED Digital Volt Meter</p>  <ul style="list-style-type: none"> * 3Phase/4wire * Voltage range : 450VAC (L-N) / 750VAC * Operating power : 200-240VAC * Class : 0.5 * Size 96x96, 72x72 	FCN300-V3	420,000
<p>1-Phase AC LED Digital HZ Meter</p>  <ul style="list-style-type: none"> * 1Phase/2wire * Voltage range : 0-450VAC * Operating power : 200-240VAC * Frequency range : 45-65Hz * Class : 0.5 * Size 96x96, 72x72, 48x96 	FCN300-F1	230,000



Description	Type	Price (Rp)
 <p>STAR - DELTA Timer</p> <ul style="list-style-type: none"> * Operating voltage : 12-240VAC/DC * Output contact : 2xSPDT * Current range : 2X16A * Time t1(star) : 0.1s - 10minute * Time t2(delay) : 0.1 - 1seconds 	FBT7-E	235,000
 <p>ANALOG Timer 24hours</p> <ul style="list-style-type: none"> * 1 Channels daily program 24hours * Operating voltage : 230-240VAC * Power reserve : 3 day * Switching capacity : 250VAC/16A (resistive load) 1000watt (Lamp load) * Shortest Switching time : 15min 	FT180A	200,000
 <p>STAIRCASE Lighting Timer</p> <ul style="list-style-type: none"> * Automatic control switch on-off lighting * Operating voltage : 200 - 240VAC * Switching capacity : 1NO 250VAC/16A (resistive load) 1000wa(Lamp load) * Adjustable time delay setting : 30s - 30min 	FTS-1	167,000
 <p>ANALOG PLUG-IN Timer</p> <ul style="list-style-type: none"> * 24hours timer * Operating voltage : 200-230VAC * Program per day : 48 ON/OFF * Switching capacity : 230VAC/16A (resistive load), 3680watt (Lamp load) * Min. setting g time : 15mins * Plug with children protection 	FTG-16A	70,000
	FTG-63A	74,000
 <p>DIGITAL WEEKLY PLUG-IN Timer</p> <ul style="list-style-type: none"> * Weekly timer (7day setting) * Operating voltage : 200-230VAC * Program per day : 18/20 ON/OFF * Switching capacity : 230VAC/16A (resistive load), 3680watt (Lamp load) * Min. setting g time : 1mins/1seconds * Rechargeable NI-MH battery * Plug with children protection 	FETG-68A <i>(16 ON/OFF)</i>	133,000
	FETG-63A <i>(20 ON/OFF)</i>	142,000

CONNECTOR CCO ALLUMINIUM



Description	Size	Type	Price (Rp)
	16-16	FTCCO-16/16	3,700
	16-35	FTCCO-16/35	4,400
	35-35	FTCCO-35/35	6,200
	35-70	FTCCO-35/70	7,700
	50-70	FTCCO-50/70	12,000
	70-70	FTCCO-70/70	12,400
	70-150	FTCCO-70/150	27,700
	150-150	FTCCO-150/150	30,800
	150-240	FTCCO-150/240	46,000
	240-240	FTCCO-240/240	49,000



ENGSEL PANEL

Description	Type	Price (Rp)
	HX233	32,000

PRESSURE TRANSMITTER

Description	Pressure	Type	Price (Rp)
 <ul style="list-style-type: none"> * Input : 10 - 30VDC * Output : 4 -20mA * Pressure Port : G 1/4 * Protection Grade : IP65 	0 - 10bar	LFT2000-10	630,000
	0 - 16bar	LFT2000-16	650,000
	0 - 30bar	LFT2000-30	700,000

CONTROL BOX GROUNDING / FURSE INSPECTION PIT

Description	Size	Material	Description	Type	Price (Rp)
	300X300X210	PP + Fiber Glass (Anti panas/ tidak mudah pecah)	Box Only	FSWL-3030W	590,000
			Box with Busbar Copper Grounding	FSWL-3030WBC	770,000
	280X280*180	Resin (Anti panas/ tidak mudah pecah)	Box Only	FSWL-2828-B	550,000
			Box with Busbar Copper Grounding	FSWL-2828-BBC	740,000

KC-270 Series

Untuk aplikasi pemakaian di Hoist crane

Advantages is:

1. Customizable Anti-Shaking function to suppress load sway
2. Safety protection during hoisting (Anti-Dropping)
3. Stable power output during VFD starting
4. Standard CANopen communication protocol





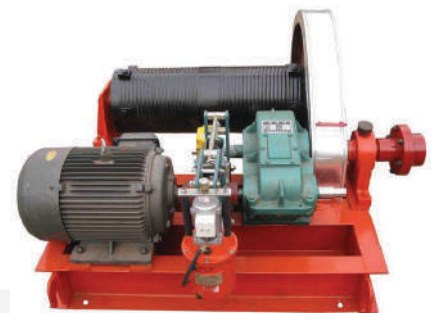



Model/Type	Description	Price (Rp)
KC270-4T-0015G	15KW,3-phase,320V~460V	12,100,000
KC270-4T-0018G	18.5KW,3-phase,320V~460V	13,550,000
KC270-4T-0022G	22KW,3-phase,320V~460V	18,650,000
KC270-4T-0030G	30KW,3-phase,320V~460V	23,287,000
KC270-4T-0037G	37KW,3-phase,320V~460V	28,882,000
KC270-4T-0045G	45KW,3-phase,320V~460V	35,570,000
KC270-4T-0055G	55KW,3-phase,320V~460V	45,670,000
KC270-4T-0075G	75KW,3-phase,320V~460V	51,050,000
KC270-4T-0090G	90KW,3-phase,320V~460V	54,890,000
KC270-4T-0110G	110KW,3-phase,320V~460V	71,920,000
KC270-4T-0132G	132KW,3-phase,320V~460V	81,245,000
KC270-4T-0160G	160KW,3-phase,320V~460V	145,123,000
KC270-4T-0185G	185KW,3-phase,320V~460V	165,504,000
KC270-4T-0200G	200KW,3-phase,320V~460V	179,349,000
KC270-4T-0220G	220KW,3-phase,320V~460V	216,100,000



KC270 Main Application field:

- Electric hoist
- Bridge crane
- Gantry crane
- Tower crane
- Winch
- Logistics hoist
- Port machinery



Description	Type	Price (Rp)
Analog Voltage Protection Relay  <ul style="list-style-type: none"> * Over Voltage : 2% - 20% * Under Voltage : -20% - 2% * Phase Sequence * Phase Failure * Delay Time : 2s 	FBT8-B02	248,000
Analog Voltage Protection Relay  <ul style="list-style-type: none"> * Over Voltage : 2% - 20% * Under Voltage : -20% - 2% * Delay Time : 0,1s - 10s * Asymmetry : 8% * Phase Sequence * Phase Failure 	FBT8-B03	318,000
Analog Phase Protection Relay  <ul style="list-style-type: none"> * Asymmetry : 8% * Phase Sequence * Phase Failure * Delay Time : 0,1s - 10s 	FBT8-B06	224,000
3-Phase Digital Voltage Protection Relay  <ul style="list-style-type: none"> * Rated voltage (Un) : 220VAC (L1-N) * Operating range : (0,8-1,1) x Un * Frequency : 50/60 Hz * Under Voltage (UV) : Umin = 300-370VAC * Over Voltage (OV) : Umax = 390-460VAC * Unbalanced Voltage (asymmetry) : (0,05-0,20) %5-20 * Phase Failure * Phase Sequence * On delay time (Voltages) : 00.1-99,9 Sec * On delay time (Frequency) : 00.1-99,9 Sec * Returning delay Time : 00,1-99,9 Sec 	FDPR3V	542,000
1-phase Digital Voltage & Current Protection Relay  <ul style="list-style-type: none"> * 1 Phase 220VAC * Rated Voltage : 100 - 450VAC * Rated Current : 1-63A (Default 63A) * Over Voltage Range : 230 - 300VAC (Default 270V) * Under Voltage Range : 140 - 210VAC (Default 170V) * Voltage Delay Time : 1-400s (Default 2s) * Current Delay Time : 1-30s (Default 5s) * Reconnect time : 1-400s (Default 3s) 	FDPVAP-1	170,000
3-Phase Digital Voltage & Current Protection Relay  <ul style="list-style-type: none"> * Rated Working Voltage: AC220V * Operating Voltage range : AC140V-500V (3 Phase) * Rated Frequency : 50/60 Hz * Rated Working Current : 1-100A * Over Voltage Protection : 390-500VAC; 230-300VAC * Under Voltage Protection : 140V-370VAC; 140-210VAC * Voltage Power off time : 1-400s * Overcurrent Protection Value : 1-100A * Overcurrent Power off time : 1-30s * Recover time (Starting Delay Time : 1-400s 	FDPVAP-3	619,500



NEW PILOT LAMP

Description	Color	Type	Price (Rp)
 <p>Lebih terang - Lebih hemat NEW PRODUCT</p> <p>* Input voltage : 220VAC/DC * Size : 22mm</p>	Red Green Yellow Blue White	FAD22-22DS	7,250

POTENTIOMETER



Description	Resistance	Type	Price (Rp)
 <p>* Size : 22mm</p>	1k Ω , 5k Ω , 10k Ω , 20k Ω , 50k Ω	FAD116-22PM	38,500

WATER - PROOF MCB BOX

Description	Grup	Qty/Carton (pcs)	Type	Price/PC (Rp)
 <p>* Material : ABS * Protection Degree : IP65 * Water proof * Rubber sealing in the cover box * Surface mounted / Out Bow</p>	5	40	FHT-5W	91,000
	8	30	FHT-8W	129,000
	12	20	FHT-12W	186,000
	18	15	FHT-18W	266,000
	24	10	FHT-24W	329,000

INDUSTRIAL DISTRIBUTION BOX





Description	Type	Price (Rp)
<p>6 Way Distribution Box</p> <p>* BOX material ABS, IP55 * Voltage : 220-250VAC/16A * 3pcs Socket 3X16A, IP44 * 3pcs Socket 3X16, IP67 * ELCB 2P/25A, HIMEL (SNI) * MCB 1P/16A, HIMEL (SNI) * Include cable 3X2.5mm, 2Meter (SNI)</p> 	FT-G058	1,900,000
<p>3 Way Distribution Box</p> <p>* Box Material ABS, IP55 * Volatge : 220-250VAC / 16A * 3pcs Socket 3X16A, IP44 * ELCB 2P/25A, Himel (SNI) * MCB 1P/16A, Himel (SNI) * Include cable 3X2.5mm, 2Meter (SNI)</p> 	FT-ZH1802-A	1,350,000



AUTO TRANSFER SWITCH

Specification :



- * Control Power Supply : 220VAC / 7Amperer, 50Hz
- * Rated short time current : 10kA
- * Mechanical time : 17000 time
- * Electrical time : 6000 time
- * Operation Cycle time (waktu pemindahan posisi) : 0.1 second/detik
- * Sistem Kerja perpindahan posisi I-0-II dengan Selenoid
- * 2 Input / 1 Ouput

Description		Type	Price (Rp)
	63A/4POLE	FTGQ5-125IE63A-4	2,830,000
	100A/4POLE	FTGQ5-125IE100A-4	3,000,000
	125A/4POLE	FTGQ5-125IE125A-4	3,200,000
	160A/4POLE	FTGQ5-250IE160A-4	8,600,000
	250A/4POLE	FTGQ5-250IE250A-4	8,800,000
	400A/4POLE	FTGQ5-400IE400A-4	10,700,000
	630A/4POLE	FTGQ5-6300IE630A-4	11,700,000

DC DIGITAL PANEL METER



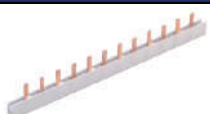

Description	Size	Type	Price (Rp)
DC AMPERE METER			
 <ul style="list-style-type: none"> * 1Phase/2wire * Operating power : 200-240VAC * Ampere range : 0 - 9999ADC * With Shunt ../75mV * Class : 0.5 	96 X 96	FCN300A-96DC	365,000
	72 X 72	FCN300A-72DC	365,000
	48 X 96	FCN300A-48DC	365,000
DC VOLT METER			
 <ul style="list-style-type: none"> * 1Phase/2wire * Operating power : 200-240VAC * Voltage range : 600VDC * Class : 0.5 	96 X 96	FCN300V-96DC	365,000
	72 X 72	FCN300V-72DC	365,000
	48 X 96	FCN300V-48DC	365,000



BUSBAR SISIR

Description	Size	Ampere	Type	Price (Rp)
 Busbar MCB 2Phase	27 X 2 Pole	63A	FBM-2T	152,000
 Busbar MCB 4Phase	14 X 4 Pole	100A	FBM-4	428,000



Earth Fault Relay & Over Current Protection Relay



Description	Type	Price (Rp)
<p>Earth Fault Relay</p>  <ul style="list-style-type: none"> * Power voltage : 240VAC/50Hz ± 10% * Current Transformer / CT rasio : .../5A * VA rating : 3VA(max) * Tripping contact rated voltage : 250VAC * Tripping contact rated continuous current : 6A * Low set earth fault : 0.1 - 2A * High set earth fault : 1x I - 5x I * Time delay (DELAY) adjustment : 0.1 - 1.0sec * Panel mounted size : 96*96 	FKER-141	1,520,000
 <ul style="list-style-type: none"> * Power voltage : 240VAC/50Hz ± 10% * Current Transformer / CT rasio : .../5A * VA rating : 3VA(max) * Tripping contact rated voltage : 250VAC * Tripping contact rated continuous current : 6A * Low set earth fault : 0.1 - 2A * High set earth fault : 1x I - 5x I * Time multiplier (TM) adjustment : 0.01 - 1.0sec * Panel mounted size : 96*96 	FKER-152	1,765,000
<p>Over Current Relay</p>  <ul style="list-style-type: none"> * Power voltage : 240VAC/50Hz ± 10% * Current Transformer / CT rasio : .../5A * VA rating : 3VA(max) * Tripping contact rated voltage : 250VAC * Tripping contact rated continuous current : 6A * Low set over current : 2 - 6A * High set over current : 1x I - 5x I * Time delay (IDT) adjustment : 0.01 - 1.0sec * Panel mounted size : 96*96 	FKCR151	1,990,000
 <ul style="list-style-type: none"> * Power voltage : 240VAC/50Hz ± 10% * Current Transformer / CT rasio : .../5A * VA rating : 3VA(max) * Tripping contact rated voltage : 250VAC * Tripping contact rated continuous current : 6A * Low set over current : 2 - 6A * High set over current : 1x I - 5x I * Time multiplier (TM) adjustment : 0.01 - 1.0sec * Panel mounted size : 96*96 	FKCR153	2,040,000

Description		Type	Price (Rp)
 <ul style="list-style-type: none"> * Power voltage : 240VAC/50Hz \pm 10% * Zero CT connection monitoring * VA rating : 3VA(max) * Tripping contact rated voltage : 250VAC * Tripping contact rated continuous current : 6A * Earth leakage tripping current setting : 0.1 - 1.0A * Time delay (DELAY) setting : 0.1 - 3.0sec * Panel mounted size : 96*96 		FKLR121	1,294,000
		 <ul style="list-style-type: none"> * Power voltage : 240VAC/50Hz \pm 10% * Zero CT connection monitoring * VA rating : 3VA(max) * Tripping contact rated voltage : 250VAC * Tripping contact rated continuous current : 6A * Earth leakage tripping current setting : 30mA - 30A * Time delay (DELAY) setting : 0 - 3.0sec * DIN - RAIL mounted 	FKLR523

Zero Phase Current Transformers / Zero CT

Description	Diameter (mm)	Type	Price (Rp)	
 <ul style="list-style-type: none"> * Operation current range : 30mA - 30A * Class : 5P10 		40	FKTC-40	230,000
		80	FKTC-80	450,000
		100	FKTC-100	462,000
		150	FKTC-150	649,000
		200	FKTC-200	1,221,000

Description	Type	Price (Rp)
3Phase DIN - Rail Digital Multimeter/Power Meter Measurement function : V, A, Hz, kW, Kwh, kVar, kVA, Cos ϕ , kVarh. <ul style="list-style-type: none"> * Communication via Modbus RS485 * 3Phase/4wire * Voltage range : 0-450VAC * Ampere range : 0-9999/5A/1A * Frequency range : 45-65Hz * Operating power : 200-240VAC * Class : 0.5 		FCN-3D4PY 1,110,000
Power Factor Controller 24 Step LCD Measurement function : Cos ϕ , V, A, Hz, kW, Kvr <ul style="list-style-type: none"> * Power voltage : 220VAC/50Hz * Control output : 220VAC/3A * Output Signal : 24 Step * Communication via Modbus RS485 * Size : 144*144*76 		



Hydrophore Sequencing Relay

Description	Output Contact	Type	Price (Rp)
 <ul style="list-style-type: none"> * Operating Voltage : 150-150VAC (L-N) / 50Hz * Contact Relay : 3A/250VAC * Delay time range : off, 10min - 12hour * Contact Output : 2 pump & 3 pumps 	2 Pumps	FHSR-02X	450,000
	3 Pumps	FHSR-03X	550,000



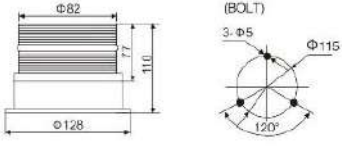

Solar Warning Light (Warning lamp tenaga surya)







Description	Color	Type	Price (Rp)
  <ul style="list-style-type: none"> * Flashing Light * LED life time : 20.000 hours * Battery : 2000mAh/3.7V rechargeable battery * Solar cell : Φ 80, 120mA * Recharged 8 hours can work 120-150 hours * Power LED : 2 Watt * Magnet base (dudukan magnet) * Protection : IP65 	RED YELLOW BLUE	FLTD-5095-2	276,000

Heatshrink Cable Breakout / Celana Kabel



Description	Diameter hole (mm)	Cable Size(mm)	Type	Price (Rp)
 <ul style="list-style-type: none"> * 3 Core cable * Voltage : 1kV - 6.6kV 	3*13 / 1*34	10 - 16	FRSZT-1/3.0	28,000
	3*16 / 1*43	25 - 50	FRSZT-1/3.1	29,000
	3*26 / 1*55	70 - 120	FRSZT-1/3.2	34,000
	3*40 / 1*75	150 - 240	FRSZT-1/3.3	59,000
	3*50 / 1*85	300 - 400	FRSZT-1/3.4	69,000
 <ul style="list-style-type: none"> * 4 Core cable * Voltage : 1kV - 6.6kV 	4*13 / 1*36	10 - 16	FRSZT-1/4.0	29,000
	4*16 / 1*49	25 - 50	FRSZT-1/4.1	30,000
	4*26 / 1*69	70 - 120	FRSZT-1/4.2	35,000
	4*40 / 1*80	150 - 240	FRSZT-1/4.3	62,000
	4*50 / 1*94	300 - 400	FRSZT-1/4.4	76,000



Description		Type	Price (Rp)	
WaterProof Connection BOX * Material : PC/PA66 * IP Protection : IP68 * Capacity : 24A / 450VAC * Temperature Rating : -40°C ~ +105°C * Cabel Range : 0.5 - 6mm		2 WAY	FM686-2	56,900
		3 WAY	FM686-3	61,500
		4 WAY	FM686-4A	66,200
			FM686-4B	69,200
		5 WAY	FM686-5	92,300
		6 WAY	FM686-6	100,000

Description		Type	Price (Rp)	
Hour Meter * Parameter : 0 - 99999,99 hours * Voltage : 220 - 240VAC / 50Hz		48 X 48mm	FHM-2	184000

Description		Type	Price (Rp)	
Brass Cable Gland * Material : Nickel - Plated Brass * IP Protection : IP65		44 - 37mm	M63 X 1.5	270,000
		52 - 42mm	M75 X 2	445,000
		70 - 60mm	M88 X 2	750,000
		80 - 70mm	M100 X 2	1,516,000



Fire Extinguishing Divice

Description	Type	Price (Rp)
 <ul style="list-style-type: none">* Operating temperature : 50°C - 90°C* Service life : 10 years* Thermal Detection Response Time : ≤5s* Protected Space/m³ : ≤0.1m³* Effective Extinguishing time : ≤30s	FST-MHZZ-01	132,500