

PRICE LIST CABLE TRAY DAN LADDER FORT



Spesifikasi

Tebal Plat 1,8 mm

Panjang 3 Meter

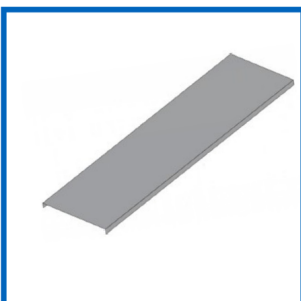
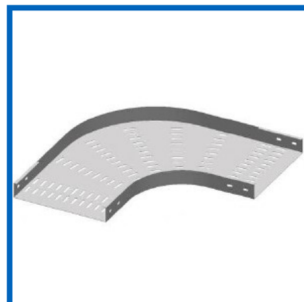
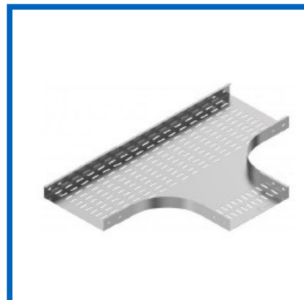
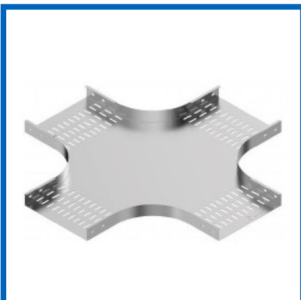

CABLE TRAY

U - TRAY



Specification :

* Material : Hot Rolled Miled Steel Sheet (SPHC)

* Thickness : 1.8mm

* Plating : Electro Galvanize / Hotdip Galvanize

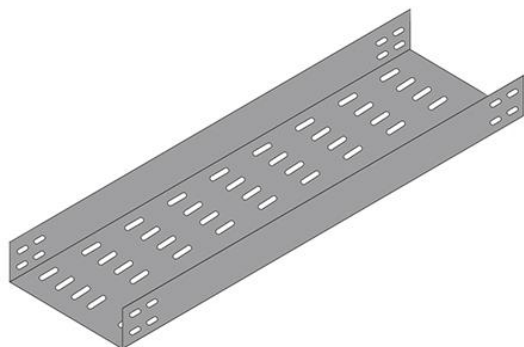

Type		Size (mm)				Price (Rp)	
Electro Galvanize	Hotdip Galvanize	Width	Height	Length	Thickness	Electro GV	Hotdip GV
FUCT-EG-0550-30-018	FUCT-HDG-0550-30-018	50	50	3000	1.8	255,000	322,000
FUCT-EG-1050-30-018	FUCT-HDG-1050-30-018	100	50	3000	1.8	340,000	429,000
FUCT-EG-1550-30-018	FUCT-HDG-1550-30-018	150	50	3000	1.8	425,000	536,000
FUCT-EG-2050-30-018	FUCT-HDG-2050-30-018	200	50	3000	1.8	510,000	643,000
FUCT-EG-2550-30-018	FUCT-HDG-2550-30-018	250	50	3000	1.8	595,000	749,000
FUCT-EG-3050-30-018	FUCT-HDG-3050-30-018	300	50	3000	1.8	680,000	859,000
FUCT-EG-4050-30-018	FUCT-HDG-4050-30-018	400	50	3000	1.8	851,000	1,072,000
FUCT-EG-5050-30-018	FUCT-HDG-5050-30-018	500	50	3000	1.8	1,021,000	1,287,000
FUCT-EG-6050-30-018	FUCT-HDG-6050-30-018	600	50	3000	1.8	1,191,000	1,501,000
FUCT-EG-8050-30-018	FUCT-HDG-8050-30-018	800	50	3000	1.8	1,537,000	1,953,000
FUCT-EG-10050-30-018	FUCT-HDG-10050-30-018	1000	50	3000	1.8	1,883,000	2,415,000

Type		Size (mm)				Price (Rp)	
Electro Galvanize	Hotdip Galvanize	Width	Height	Length	Thickness	Electro GV	Hotdip GV
FUCT-EG-10100-30-018	FUCT-HDG-10100-30-018	100	100	3000	1.8	510,000	643,000
FUCT-EG-15100-30-018	FUCT-HDG-15100-30-018	150	100	3000	1.8	595,000	749,000
FUCT-EG-20100-30-018	FUCT-HDG-20100-30-018	200	100	3000	1.8	680,000	859,000
FUCT-EG-25100-30-018	FUCT-HDG-25100-30-018	250	100	3000	1.8	765,000	965,000
FUCT-EG-30100-30-018	FUCT-HDG-30100-30-018	300	100	3000	1.8	851,000	1,072,000
FUCT-EG-40100-30-018	FUCT-HDG-40100-30-018	400	100	3000	1.8	1,021,000	1,287,000
FUCT-EG-50100-30-018	FUCT-HDG-50100-30-018	500	100	3000	1.8	1,191,000	1,501,000
FUCT-EG-60100-30-018	FUCT-HDG-60100-30-018	600	100	3000	1.8	1,361,000	1,717,000
FUCT-EG-80100-30-018	FUCT-HDG-80100-30-018	800	100	3000	1.8	1,708,000	2,169,000
FUCT-EG-100100-30-018	FUCT-HDG-100100-30-018	1000	100	3000	1.8	2,056,000	2,634,000

CABLE TRAY

C - TRAY



Specification :

* Material : Hot Rolled Miled Steel Sheet (SPHC)

* Thickness : 1.8mm

* Plating : Electro Galvanize / Hotdip Galvanize

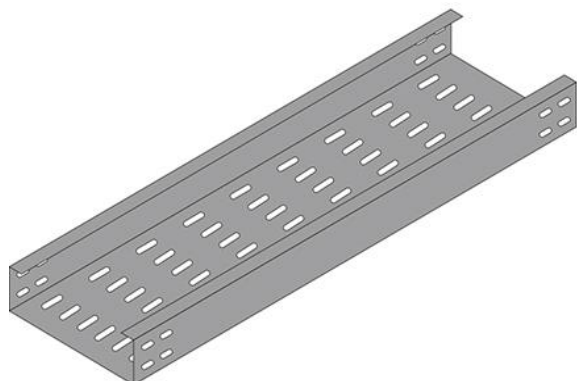

Type		Size (mm)				Price (Rp)	
Electro Galvanize	Hotdip Galvanize	Width	Height	Length	Thickness	Electro GV	Hotdip GV
FCCT-EG-0550-30-018	FCCT-HDG-0550-30-018	50	50	3000	1.8	273,000	348,000
FCCT-EG-1050-30-018	FCCT-HDG-1050-30-018	100	50	3000	1.8	353,000	450,000
FCCT-EG-1550-30-018	FCCT-HDG-1550-30-018	150	50	3000	1.8	437,000	556,000
FCCT-EG-2050-30-018	FCCT-HDG-2050-30-018	200	50	3000	1.8	522,000	666,000
FCCT-EG-2550-30-018	FCCT-HDG-2550-30-018	250	50	3000	1.8	606,000	772,000
FCCT-EG-3050-30-018	FCCT-HDG-3050-30-018	300	50	3000	1.8	690,000	879,000
FCCT-EG-4050-30-018	FCCT-HDG-4050-30-018	400	50	3000	1.8	858,000	1,094,000
FCCT-EG-5050-30-018	FCCT-HDG-5050-30-018	500	50	3000	1.8	1,026,000	1,308,000
FCCT-EG-6050-30-018	FCCT-HDG-6050-30-018	600	50	3000	1.8	1,195,000	1,524,000
FCCT-EG-8050-30-018	FCCT-HDG-8050-30-018	800	50	3000	1.8	1,537,000	1,979,000
FCCT-EG-10050-30-018	FCCT-HDG-10050-30-018	1000	50	3000	1.8	1,879,000	2,437,000

Type		Size (mm)				Price (Rp)	
Electro Galvanize	Hotdip Galvanize	Width	Height	Length	Thickness	Electro GV	Hotdip GV
FCCT-EG-10100-30-018	FCCT-HDG-10100-30-018	100	100	3000	1.8	528,000	666,000
FCCT-EG-15100-30-018	FCCT-HDG-15100-30-018	150	100	3000	1.8	613,000	772,000
FCCT-EG-20100-30-018	FCCT-HDG-20100-30-018	200	100	3000	1.8	698,000	879,000
FCCT-EG-25100-30-018	FCCT-HDG-25100-30-018	250	100	3000	1.8	783,000	987,000
FCCT-EG-30100-30-018	FCCT-HDG-30100-30-018	300	100	3000	1.8	868,000	1,094,000
FCCT-EG-40100-30-018	FCCT-HDG-40100-30-018	400	100	3000	1.8	1,038,000	1,308,000
FCCT-EG-50100-30-018	FCCT-HDG-50100-30-018	500	100	3000	1.8	1,210,000	1,524,000
FCCT-EG-60100-30-018	FCCT-HDG-60100-30-018	600	100	3000	1.8	1,380,000	1,737,000
FCCT-EG-80100-30-018	FCCT-HDG-80100-30-018	800	100	3000	1.8	1,727,000	2,206,000
FCCT-EG-100100-30-018	FCCT-HDG-100100-30-018	1000	100	3000	1.8	2,075,000	2,667,000

CABLE TRAY

Cover U & C - TRAY



Specification :

* Material : Hot Rolled Miled Steel Sheet (SPHC)

* Thickness : 1.8mm

* Plating : Electro Galvanize / Hotdip Galvanize

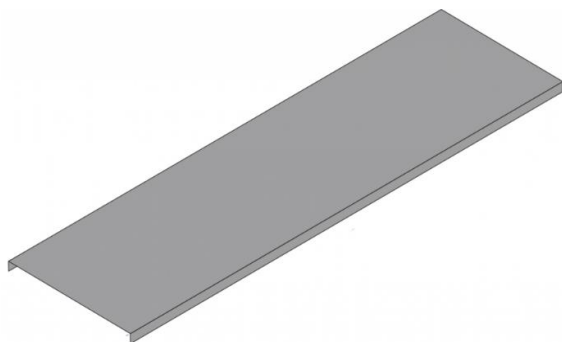

Type		Size (mm)			Price (Rp)	
Electro Galvanize	Hotdip Galvanize	Width	Length	Thickness	Electro GV	Hotdip GV
FCT-EG-50-30-018	FCT-HDG-50-30-018	50	3000	1.8	125,000	171,000
FCT-EG-100-30-018	FCT-HDG-100-30-018	100	3000	1.8	209,000	286,000
FCT-EG-150-30-018	FCT-HDG-150-30-018	150	3000	1.8	295,000	401,000
FCT-EG-200-30-018	FCT-HDG-200-30-018	200	3000	1.8	380,000	516,000
FCT-EG-250-30-018	FCT-HDG-250-30-018	250	3000	1.8	465,000	632,000
FCT-EG-300-30-018	FCT-HDG-300-30-018	300	3000	1.8	549,000	747,000
FCT-EG-400-30-018	FCT-HDG-400-30-018	400	3000	1.8	720,000	977,000
FCT-EG-500-30-018	FCT-HDG-500-30-018	500	3000	1.8	888,000	1,209,000
FCT-EG-600-30-018	FCT-HDG-600-30-018	600	3000	1.8	1,058,000	1,439,000
FCT-EG-800-30-018	FCT-HDG-800-30-018	800	3000	1.8	1,398,000	1,901,000
FCT-EG-1000-30-018	FCT-HDG-1000-30-018	1000	3000	1.8	1,737,000	2,364,000

CABLE TRAY

Horizontal Elbow - TRAY



Specification :

- * Material : Hot Rolled Miled Steel Sheet (SPHC)
- * Thickness : 1.8mm
- * Radius : 300mm
- * Bend Angel : 90 degree
- * Plating : Electro Galvanize / Hotdip Galvanize

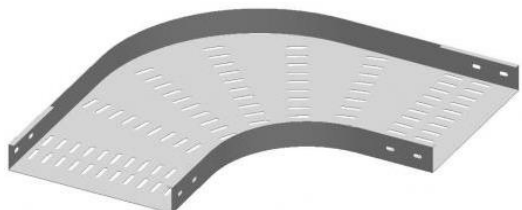

Type		Size (mm)			Price (Rp)	
Electro Galvanize	Hotdip Galvanize	Width	Height	Thickness	Electro GV	Hotdip GV
FLCT-EG-0550-018	FLCT-HDG-0550-018	50	50	1.8	134,000	167,000
FLCT-EG-1050-018	FLCT-HDG-1050-018	100	50	1.8	165,000	209,000
FLCT-EG-1550-018	FLCT-HDG-1550-018	150	50	1.8	202,000	257,000
FLCT-EG-2050-018	FLCT-HDG-2050-018	200	50	1.8	239,000	312,000
FLCT-EG-2550-018	FLCT-HDG-2550-018	250	50	1.8	284,000	371,000
FLCT-EG-3050-018	FLCT-HDG-3050-018	300	50	1.8	330,000	434,000
FLCT-EG-4050-018	FLCT-HDG-4050-018	400	50	1.8	437,000	578,000
FLCT-EG-5050-018	FLCT-HDG-5050-018	500	50	1.8	558,000	742,000
FLCT-EG-6050-018	FLCT-HDG-6050-018	600	50	1.8	694,000	927,000
FLCT-EG-8050-018	FLCT-HDG-8050-018	800	50	1.8	1,012,000	1,359,000
FLCT-EG-10050-018	FLCT-HDG-10050-018	1000	50	1.8	1,392,000	1,873,000

Type		Size (mm)			Price (Rp)	
Electro Galvanize	Hotdip Galvanize	Width	Height	Thickness	Electro GV	Hotdip GV
FLCT-EG-10100-018	FLCT-HDG-10100-018	100	100	1.8	212,000	272,000
FLCT-EG-15100-018	FLCT-HDG-15100-018	150	100	1.8	251,000	324,000
FLCT-EG-20100-018	FLCT-HDG-20100-018	200	100	1.8	292,000	382,000
FLCT-EG-25100-018	FLCT-HDG-25100-018	250	100	1.8	339,000	445,000
FLCT-EG-30100-018	FLCT-HDG-30100-018	300	100	1.8	389,000	515,000
FLCT-EG-40100-018	FLCT-HDG-40100-018	400	100	1.8	500,000	665,000
FLCT-EG-50100-018	FLCT-HDG-50100-018	500	100	1.8	628,000	838,000
FLCT-EG-60100-018	FLCT-HDG-60100-018	600	100	1.8	769,000	1,029,000
FLCT-EG-80100-018	FLCT-HDG-80100-018	800	100	1.8	1,101,000	1,479,000
FLCT-EG-100100-018	FLCT-HDG-100100-018	1000	100	1.8	1,491,000	2,011,000

CABLE TRAY



Horizontal Diagonal - TRAY

Specification :

- * Material : Hot Rolled Miled Steel Sheet (SPHC)
- * Thickness : 1.8mm
- * Radius : 300mm
- * Bend Angel : 90 degree
- * Plating : Electro Galvanize / Hotdip Galvanize

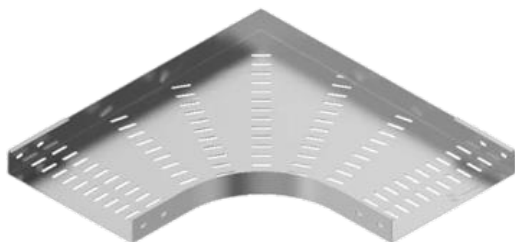

Type		Size (mm)			Price (Rp)	
Electro Galvanize	Hotdip Galvanize	Width	Height	Thickness	Electro GV	Hotdip GV
FDCT-EG-0550-018	FDCT-HDG-0550-018	50	50	1.8	134,000	167,000
FDCT-EG-1050-018	FDCT-HDG-1050-018	100	50	1.8	165,000	209,000
FDCT-EG-1550-018	FDCT-HDG-1550-018	150	50	1.8	202,000	257,000
FDCT-EG-2050-018	FDCT-HDG-2050-018	200	50	1.8	239,000	312,000
FDCT-EG-2550-018	FDCT-HDG-2550-018	250	50	1.8	284,000	371,000
FDCT-EG-3050-018	FDCT-HDG-3050-018	300	50	1.8	330,000	434,000
FDCT-EG-4050-018	FDCT-HDG-4050-018	400	50	1.8	437,000	578,000
FDCT-EG-5050-018	FDCT-HDG-5050-018	500	50	1.8	558,000	742,000
FDCT-EG-6050-018	FDCT-HDG-6050-018	600	50	1.8	694,000	927,000
FDCT-EG-8050-018	FDCT-HDG-8050-018	800	50	1.8	1,012,000	1,359,000
FDCT-EG-10050-018	FDCT-HDG-10050-018	1000	50	1.8	1,392,000	1,873,000

Type		Size (mm)			Price (Rp)	
Electro Galvanize	Hotdip Galvanize	Width	Height	Thickness	Electro GV	Hotdip GV
FDCT-EG-10100-018	FDCT-HDG-10100-018	100	100	1.8	212,000	272,000
FDCT-EG-15100-018	FDCT-HDG-15100-018	150	100	1.8	251,000	324,000
FDCT-EG-20100-018	FDCT-HDG-20100-018	200	100	1.8	292,000	382,000
FDCT-EG-25100-018	FDCT-HDG-25100-018	250	100	1.8	339,000	445,000
FDCT-EG-30100-018	FDCT-HDG-30100-018	300	100	1.8	389,000	515,000
FDCT-EG-40100-018	FDCT-HDG-40100-018	400	100	1.8	500,000	665,000
FDCT-EG-50100-018	FDCT-HDG-50100-018	500	100	1.8	628,000	838,000
FDCT-EG-60100-018	FDCT-HDG-60100-018	600	100	1.8	769,000	1,029,000
FDCT-EG-80100-018	FDCT-HDG-80100-018	800	100	1.8	1,101,000	1,479,000
FDCT-EG-100100-018	FDCT-HDG-100100-018	1000	100	1.8	1,491,000	2,011,000

CABLE TRAY



Cover Horizontal Elbow & Diagonal - TRAY

Specification :

- * Material : Hot Rolled Miled Steel Sheet (SPHC)
- * Thickness : 1.8mm
- * Radius : 300mm
- * Bend Angel : 90 degree
- * Plating : Electro Galvanize / Hotdip Galvanize

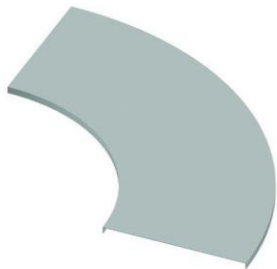

ELBOW



DIAGONAL

Type		Size (mm)		Price (Rp)	
Electro Galvanize	Hotdip Galvanize	Width	Thickness	Electro GV	Hotdip GV
FHLC-EG-50-018	FHLC-HDG-50-018	50	1.8	97,000	117,000
FHLC-EG-100-018	FHLC-HDG-100-018	100	1.8	127,000	158,000
FHLC-EG-150-018	FHLC-HDG-150-018	150	1.8	160,000	203,000
FHLC-EG-200-018	FHLC-HDG-200-018	200	1.8	196,000	252,000
FHLC-EG-250-018	FHLC-HDG-250-018	250	1.8	238,000	309,000
FHLC-EG-300-018	FHLC-HDG-300-018	300	1.8	283,000	368,000
FHLC-EG-400-018	FHLC-HDG-400-018	400	1.8	383,000	506,000
FHLC-EG-500-018	FHLC-HDG-500-018	500	1.8	500,000	664,000
FHLC-EG-600-018	FHLC-HDG-600-018	600	1.8	632,000	843,000
FHLC-EG-800-018	FHLC-HDG-800-018	800	1.8	940,000	1,263,000
FHLC-EG-1000-018	FHLC-HDG-1000-018	1000	1.8	1,310,000	1,765,000

CABLE TRAY



Horizontal Tee - TRAY

Specification :

- * Material : Hot Rolled Miled Steel Sheet (SPHC)
- * Thickness : 1.8mm
- * Radius : 300mm
- * Bend Angel : 90 degree
- * Plating : Electro Galvanize / Hotdip Galvanize

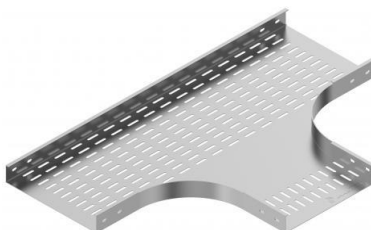

Type		Size (mm)			Price (Rp)	
Electro Galvanize	Hotdip Galvanize	Width	Height	Thickness	Electro GV	Hotdip GV
FTCT-EG-0550-018	FTCT-HDG-0550-018	50	50	1.8	233,000	286,000
FTCT-EG-1050-018	FTCT-HDG-1050-018	100	50	1.8	274,000	344,000
FTCT-EG-1550-018	FTCT-HDG-1550-018	150	50	1.8	320,000	406,000
FTCT-EG-2050-018	FTCT-HDG-2050-018	200	50	1.8	370,000	474,000
FTCT-EG-2550-018	FTCT-HDG-2550-018	250	50	1.8	424,000	546,000
FTCT-EG-3050-018	FTCT-HDG-3050-018	300	50	1.8	482,000	626,000
FTCT-EG-4050-018	FTCT-HDG-4050-018	400	50	1.8	609,000	797,000
FTCT-EG-5050-018	FTCT-HDG-5050-018	500	50	1.8	750,000	990,000
FTCT-EG-6050-018	FTCT-HDG-6050-018	600	50	1.8	907,000	1,202,000
FTCT-EG-8050-018	FTCT-HDG-8050-018	800	50	1.8	1,266,000	1,692,000
FTCT-EG-10050-018	FTCT-HDG-10050-018	1000	50	1.8	1,689,000	2,264,000

Type		Size (mm)			Price (Rp)	
Electro Galvanize	Hotdip Galvanize	Width	Height	Thickness	Electro GV	Hotdip GV
FTCT-EG-10100-018	FTCT-HDG-10100-018	100	100	1.8	341,000	435,000
FTCT-EG-15100-018	FTCT-HDG-15100-018	150	100	1.8	389,000	501,000
FTCT-EG-20100-018	FTCT-HDG-20100-018	200	100	1.8	442,000	570,000
FTCT-EG-25100-018	FTCT-HDG-25100-018	250	100	1.8	496,000	646,000
FTCT-EG-30100-018	FTCT-HDG-30100-018	300	100	1.8	556,000	727,000
FTCT-EG-40100-018	FTCT-HDG-40100-018	400	100	1.8	686,000	903,000
FTCT-EG-50100-018	FTCT-HDG-50100-018	500	100	1.8	832,000	1,101,000
FTCT-EG-60100-018	FTCT-HDG-60100-018	600	100	1.8	994,000	1,321,000
FTCT-EG-80100-018	FTCT-HDG-80100-018	800	100	1.8	1,361,000	1,820,000
FTCT-EG-100100-018	FTCT-HDG-100100-018	1000	100	1.8	1,792,000	2,403,000

CABLE TRAY



Horizontal Cross - TRAY

Specification :

- * Material : Hot Rolled Miled Steel Sheet (SPHC)
- * Thickness : 1.8mm
- * Radius : 300mm
- * Bend Angel : 90 degree
- * Plating : Electro Galvanize / Hotdip Galvanize

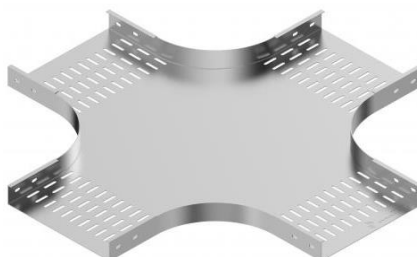

Type		Size (mm)			Price (Rp)	
Electro Galvanize	Hotdip Galvanize	Width	Height	Thickness	Electro GV	Hotdip GV
FCCT-EG-0550-018	FCCT-HDG-0550-018	50	50	1.8	388,000	472,000
FCCT-EG-1050-018	FCCT-HDG-1050-018	100	50	1.8	441,000	541,000
FCCT-EG-1550-018	FCCT-HDG-1550-018	150	50	1.8	496,000	617,000
FCCT-EG-2050-018	FCCT-HDG-2050-018	200	50	1.8	554,000	698,000
FCCT-EG-2550-018	FCCT-HDG-2550-018	250	50	1.8	618,000	783,000
FCCT-EG-3050-018	FCCT-HDG-3050-018	300	50	1.8	685,000	874,000
FCCT-EG-4050-018	FCCT-HDG-4050-018	400	50	1.8	831,000	1,072,000
FCCT-EG-5050-018	FCCT-HDG-5050-018	500	50	1.8	992,000	1,289,000
FCCT-EG-6050-018	FCCT-HDG-6050-018	600	50	1.8	1,170,000	1,529,000
FCCT-EG-8050-018	FCCT-HDG-8050-018	800	50	1.8	1,568,000	2,070,000
FCCT-EG-10050-018	FCCT-HDG-10050-018	1000	50	1.8	2,026,000	2,696,000

Type		Size (mm)			Price (Rp)	
Electro Galvanize	Hotdip Galvanize	Width	Height	Thickness	Electro GV	Hotdip GV
FCCT-EG-10100-018	FCCT-HDG-10100-018	100	100	1.8	520,000	651,000
FCCT-EG-15100-018	FCCT-HDG-15100-018	150	100	1.8	604,000	819,000
FCCT-EG-20100-018	FCCT-HDG-20100-018	200	100	1.8	663,000	899,000
FCCT-EG-25100-018	FCCT-HDG-25100-018	250	100	1.8	726,000	985,000
FCCT-EG-30100-018	FCCT-HDG-30100-018	300	100	1.8	793,000	1,076,000
FCCT-EG-40100-018	FCCT-HDG-40100-018	400	100	1.8	940,000	1,274,000
FCCT-EG-50100-018	FCCT-HDG-50100-018	500	100	1.8	1,101,000	1,494,000
FCCT-EG-60100-018	FCCT-HDG-60100-018	600	100	1.8	1,276,000	1,732,000
FCCT-EG-80100-018	FCCT-HDG-80100-018	800	100	1.8	1,676,000	2,275,000
FCCT-EG-100100-018	FCCT-HDG-100100-018	1000	100	1.8	2,135,000	2,898,000

CABLE TRAY



Cover Horizontal Tee & Cross - TRAY

Specification :

- * Material : Hot Rolled Miled Steel Sheet (SPHC)
- * Thickness : 1.8mm
- * Radius : 300mm
- * Bend Angel : 90 degree
- * Plating : Electro Galvanize / Hotdip Galvanize



COVER TEE



COVER CROSS

Cover Horizontal TEE - TRAY

Type		Size (mm)		Price (Rp)	
Electro Galvanize	Hotdip Galvanize	Width	Thickness	Electro GV	Hotdip GV
FCTE-EG-50-018	FCTE-HDG-50-018	50	1.8	176,000	209,000
FCTE-EG-100-018	FCTE-HDG-100-018	100	1.8	216,000	264,000
FCTE-EG-150-018	FCTE-HDG-150-018	150	1.8	261,000	325,000
FCTE-EG-200-018	FCTE-HDG-200-018	200	1.8	308,000	391,000
FCTE-EG-250-018	FCTE-HDG-250-018	250	1.8	361,000	462,000
FCTE-EG-300-018	FCTE-HDG-300-018	300	1.8	416,000	539,000
FCTE-EG-400-018	FCTE-HDG-400-018	400	1.8	540,000	704,000
FCTE-EG-500-018	FCTE-HDG-500-018	500	1.8	678,000	893,000
FCTE-EG-600-018	FCTE-HDG-600-018	600	1.8	832,000	1,103,000
FCTE-EG-800-018	FCTE-HDG-800-018	800	1.8	1,188,000	1,584,000
FCTE-EG-1000-018	FCTE-HDG-1000-018	1000	1.8	1,604,000	2,147,000

Cover Horizontal CROSS - TRAY

Type		Size (mm)		Price (Rp)	
Electro Galvanize	Hotdip Galvanize	Width	Thickness	Electro GV	Hotdip GV
FCZC-EG-50-018	FCZC-HDG-50-018	50	1.8	314,000	371,000
FCZC-EG-100-018	FCZC-HDG-100-018	100	1.8	366,000	440,000
FCZC-EG-150-018	FCZC-HDG-150-018	150	1.8	423,000	515,000
FCZC-EG-200-018	FCZC-HDG-200-018	200	1.8	479,000	597,000
FCZC-EG-250-018	FCZC-HDG-250-018	250	1.8	543,000	682,000
FCZC-EG-300-018	FCZC-HDG-300-018	300	1.8	613,000	773,000
FCZC-EG-400-018	FCZC-HDG-400-018	400	1.8	757,000	971,000
FCZC-EG-500-018	FCZC-HDG-500-018	500	1.8	918,000	1,191,000
FCZC-EG-600-018	FCZC-HDG-600-018	600	1.8	1,095,000	1,431,000
FCZC-EG-800-018	FCZC-HDG-800-018	800	1.8	1,493,000	1,972,000
FCZC-EG-1000-018	FCZC-HDG-1000-018	1000	1.8	1,953,000	2,596,000

CABLE TRAY



Vertical Inside Riser - TRAY

Specification :

- * Material : Hot Rolled Miled Steel Sheet (SPHC)
- * Thickness : 1.8mm
- * Radius : 300mm
- * Bend Angel : 90 degree
- * Plating : Electro Galvanize / Hotdip Galvanize



Type		Size (mm)			Price (Rp)	
Electro Galvanize	Hotdip Galvanize	Width	Height	Thickness	Electro GV	Hotdip GV
FIRT-EG-0550-018	FIRT-HDG-0550-018	50	50	1.8	107,000	139,000
FIRT-EG-1050-018	FIRT-HDG-1050-018	100	50	1.8	129,000	170,000
FIRT-EG-1550-018	FIRT-HDG-1550-018	150	50	1.8	152,000	203,000
FIRT-EG-2050-018	FIRT-HDG-2050-018	200	50	1.8	176,000	235,000
FIRT-EG-2550-018	FIRT-HDG-2550-018	250	50	1.8	199,000	266,000
FIRT-EG-3050-018	FIRT-HDG-3050-018	300	50	1.8	224,000	299,000
FIRT-EG-4050-018	FIRT-HDG-4050-018	400	50	1.8	270,000	362,000
FIRT-EG-5050-018	FIRT-HDG-5050-018	500	50	1.8	319,000	426,000
FIRT-EG-6050-018	FIRT-HDG-6050-018	600	50	1.8	366,000	491,000
FIRT-EG-8050-018	FIRT-HDG-8050-018	800	50	1.8	460,000	618,000
FIRT-EG-10050-018	FIRT-HDG-10050-018	1000	50	1.8	554,000	747,000

Type		Size (mm)			Price (Rp)	
Electro Galvanize	Hotdip Galvanize	Width	Height	Thickness	Electro GV	Hotdip GV
FIRT-EG-10100-018	FIRT-HDG-10100-018	100	100	1.8	243,000	315,000
FIRT-EG-15100-018	FIRT-HDG-15100-018	150	100	1.8	270,000	353,000
FIRT-EG-20100-018	FIRT-HDG-20100-018	200	100	1.8	297,000	390,000
FIRT-EG-25100-018	FIRT-HDG-25100-018	250	100	1.8	324,000	426,000
FIRT-EG-30100-018	FIRT-HDG-30100-018	300	100	1.8	352,000	463,000
FIRT-EG-40100-018	FIRT-HDG-40100-018	400	100	1.8	406,000	536,000
FIRT-EG-50100-018	FIRT-HDG-50100-018	500	100	1.8	460,000	612,000
FIRT-EG-60100-018	FIRT-HDG-60100-018	600	100	1.8	514,000	685,000
FIRT-EG-80100-018	FIRT-HDG-80100-018	800	100	1.8	623,000	833,000
FIRT-EG-100100-018	FIRT-HDG-100100-018	1000	100	1.8	733,000	981,000

CABLE TRAY



Vertical Outside Riser - TRAY

Specification :

- * Material : Hot Rolled Miled Steel Sheet (SPHC)
- * Thickness : 1.8mm
- * Radius : 300mm
- * Bend Angel : 90 degree
- * Plating : Electro Galvanize / Hotdip Galvanize



Type		Size (mm)			Price (Rp)	
Electro Galvanize	Hotdip Galvanize	Width	Height	Thickness	Electro GV	Hotdip GV
FORT-EG-0550-018	FORT-HDG-0550-018	50	50	1.8	98,000	129,000
FORT-EG-1050-018	FORT-HDG-1050-018	100	50	1.8	118,000	156,000
FORT-EG-1550-018	FORT-HDG-1550-018	150	50	1.8	138,000	185,000
FORT-EG-2050-018	FORT-HDG-2050-018	200	50	1.8	160,000	213,000
FORT-EG-2550-018	FORT-HDG-2550-018	250	50	1.8	180,000	240,000
FORT-EG-3050-018	FORT-HDG-3050-018	300	50	1.8	202,000	270,000
FORT-EG-4050-018	FORT-HDG-4050-018	400	50	1.8	243,000	325,000
FORT-EG-5050-018	FORT-HDG-5050-018	500	50	1.8	284,000	381,000
FORT-EG-6050-018	FORT-HDG-6050-018	600	50	1.8	324,000	438,000
FORT-EG-8050-018	FORT-HDG-8050-018	800	50	1.8	407,000	550,000
FORT-EG-10050-018	FORT-HDG-10050-018	1000	50	1.8	491,000	664,000

Type		Size (mm)			Price (Rp)	
Electro Galvanize	Hotdip Galvanize	Width	Height	Thickness	Electro GV	Hotdip GV
FORT-EG-10100-018	FORT-HDG-10100-018	100	100	1.8	205,000	271,000
FORT-EG-15100-018	FORT-HDG-15100-018	150	100	1.8	226,000	300,000
FORT-EG-20100-018	FORT-HDG-20100-018	200	100	1.8	247,000	328,000
FORT-EG-25100-018	FORT-HDG-25100-018	250	100	1.8	269,000	354,000
FORT-EG-30100-018	FORT-HDG-30100-018	300	100	1.8	288,000	384,000
FORT-EG-40100-018	FORT-HDG-40100-018	400	100	1.8	330,000	440,000
FORT-EG-50100-018	FORT-HDG-50100-018	500	100	1.8	371,000	497,000
FORT-EG-60100-018	FORT-HDG-60100-018	600	100	1.8	414,000	551,000
FORT-EG-80100-018	FORT-HDG-80100-018	800	100	1.8	495,000	665,000
FORT-EG-100100-018	FORT-HDG-100100-018	1000	100	1.8	578,000	778,000

CABLE TRAY



Cover Vertical Riser - TRAY

Specification :

* Material : Hot Rolled Miled Steel Sheet (SPHC)

* Thickness : 1.8mm

* Radius : 300mm

* Bend Angel : 90 degree

* Plating : Electro Galvanize / Hotdip Galvanize



COVER OUTSIDE

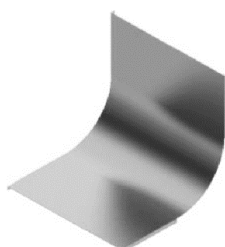

COVER INSIDE

Cover Outside Riser - TRAY

Type		Size (mm)		Price (Rp)	
Electro Galvanize	Hotdip Galvanize	Width	Thickness	Electro GV	Hotdip GV
FORC-EG-50-018	FORC-HDG-50-018	50	1.8	36,000	48,000
FORC-EG-100-018	FORC-HDG-100-018	100	1.8	70,000	93,000
FORC-EG-150-018	FORC-HDG-150-018	150	1.8	97,000	129,000
FORC-EG-200-018	FORC-HDG-200-018	200	1.8	121,000	167,000
FORC-EG-250-018	FORC-HDG-250-018	250	1.8	149,000	203,000
FORC-EG-300-018	FORC-HDG-300-018	300	1.8	176,000	238,000
FORC-EG-400-018	FORC-HDG-400-018	400	1.8	230,000	312,000
FORC-EG-500-018	FORC-HDG-500-018	500	1.8	284,000	386,000
FORC-EG-600-018	FORC-HDG-600-018	600	1.8	339,000	459,000
FORC-EG-800-018	FORC-HDG-800-018	800	1.8	447,000	607,000
FORC-EG-1000-018	FORC-HDG-1000-018	1000	1.8	556,000	752,000

Cover Inside Riser - TRAY

Type		Size (mm)		Price (Rp)	
Electro Galvanize	Hotdip Galvanize	Width	Thickness	Electro GV	Hotdip GV
FIRC-EG-50-018	FIRC-HDG-50-018	50	1.8	31,000	42,000
FIRC-EG-100-018	FIRC-HDG-100-018	100	1.8	54,000	74,000
FIRC-EG-150-018	FIRC-HDG-150-018	150	1.8	76,000	103,000
FIRC-EG-200-018	FIRC-HDG-200-018	200	1.8	98,000	132,000
FIRC-EG-250-018	FIRC-HDG-250-018	250	1.8	120,000	161,000
FIRC-EG-300-018	FIRC-HDG-300-018	300	1.8	140,000	190,000
FIRC-EG-400-018	FIRC-HDG-400-018	400	1.8	184,000	249,000
FIRC-EG-500-018	FIRC-HDG-500-018	500	1.8	226,000	307,000
FIRC-EG-600-018	FIRC-HDG-600-018	600	1.8	270,000	366,000
FIRC-EG-800-018	FIRC-HDG-800-018	800	1.8	355,000	482,000
FIRC-EG-1000-018	FIRC-HDG-1000-018	1000	1.8	442,000	598,000

CABLE TRAY

Reducer - TRAY



Specification :

* Material : Hot Rolled Miled Steel Sheet (SPHC)

* Thickness : 1.8mm

* Length : 600mm

* Plating : Electro Galvanize / Hotdip Galvanize



LEFT REDUCER



RIGHT REDUCER

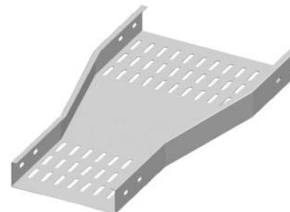

STRAIGHT REDUCER

Type		Size (mm)			Price (Rp)	
Electro Galvanize	Hotdip Galvanize	Width	Height	Thickness	Electro GV	Hotdip GV
FRCT-EG-1050-018	FRCT-HDG-1050-018	100	50	1.8	97,000	131,000
FRCT-EG-1550-018	FRCT-HDG-1550-018	150	50	1.8	120,000	163,000
FRCT-EG-2050-018	FRCT-HDG-2050-018	200	50	1.8	143,000	194,000
FRCT-EG-2550-018	FRCT-HDG-2550-018	250	50	1.8	167,000	227,000
FRCT-EG-3050-018	FRCT-HDG-3050-018	300	50	1.8	190,000	259,000
FRCT-EG-4050-018	FRCT-HDG-4050-018	400	50	1.8	238,000	320,000
FRCT-EG-5050-018	FRCT-HDG-5050-018	500	50	1.8	284,000	386,000
FRCT-EG-6050-018	FRCT-HDG-6050-018	600	50	1.8	332,000	449,000
FRCT-EG-8050-018	FRCT-HDG-8050-018	800	50	1.8	429,000	582,000
FRCT-EG-10050-018	FRCT-HDG-10050-018	1000	50	1.8	523,000	712,000

Type		Size (mm)			Price (Rp)	
Electro Galvanize	Hotdip Galvanize	Width	Height	Thickness	Electro GV	Hotdip GV
FRCT-EG-10100-018	FRCT-HDG-10100-018	100	100	1.8	130,000	190,000
FRCT-EG-15100-018	FRCT-HDG-15100-018	150	100	1.8	167,000	227,000
FRCT-EG-20100-018	FRCT-HDG-20100-018	200	100	1.8	190,000	257,000
FRCT-EG-25100-018	FRCT-HDG-25100-018	250	100	1.8	215,000	290,000
FRCT-EG-30100-018	FRCT-HDG-30100-018	300	100	1.8	239,000	323,000
FRCT-EG-40100-018	FRCT-HDG-40100-018	400	100	1.8	284,000	386,000
FRCT-EG-50100-018	FRCT-HDG-50100-018	500	100	1.8	333,000	453,000
FRCT-EG-60100-018	FRCT-HDG-60100-018	600	100	1.8	380,000	516,000
FRCT-EG-80100-018	FRCT-HDG-80100-018	800	100	1.8	482,000	655,000
FRCT-EG-100100-018	FRCT-HDG-100100-018	1000	100	1.8	582,000	788,000

CABLE TRAY



Cover Reducer - TRAY

Specification :

* Material : Hot Rolled Miled Steel Sheet (SPHC)

* Thickness : 1.8mm

* Length : 600mm

* Plating : Electro Galvanize / Hotdip Galvanize



COVER RIGHT REDUCER



COVER LEFT REDUCER



COVER STRAIGHT REDUCER

Type		Size (mm)		Price (Rp)	
Electro Galvanize	Hotdip Galvanize	Width	Thickness	Electro GV	Hotdip GV
FCRT-EG-100-018	FCRT-HDG-100-018	100	1.8	61,000	83,000
FCRT-EG-150-018	FCRT-HDG-150-018	150	1.8	84,000	114,000
FCRT-EG-200-018	FCRT-HDG-200-018	200	1.8	107,000	144,000
FCRT-EG-250-018	FCRT-HDG-250-018	250	1.8	129,000	175,000
FCRT-EG-300-018	FCRT-HDG-300-018	300	1.8	152,000	208,000
FCRT-EG-400-018	FCRT-HDG-400-018	400	1.8	199,000	270,000
FCRT-EG-500-018	FCRT-HDG-500-018	500	1.8	244,000	331,000
FCRT-EG-600-018	FCRT-HDG-600-018	600	1.8	289,000	395,000
FCRT-EG-800-018	FCRT-HDG-800-018	800	1.8	383,000	520,000
FCRT-EG-1000-018	FCRT-HDG-1000-018	1000	1.8	474,000	645,000

CABLE LADDER



U - Ladder

Specification :

* Material : Hot Rolled Miled Steel Sheet (SPHC)

* Thickness : 1.8mm

* Plating : Electro Galvanize / Hotdip Galvanize



Type		Size (mm)				Price (Rp)	
Electro Galvanize	Hotdip Galvanize	Width	Height	Length	Thickness	Electro GV	Hotdip GV
FUL-EG-10100-30-018	FUL-HDG-10100-30-018	100	100	3000	1.8	469,000	630,000
FUL-EG-15100-30-018	FUL-HDG-15100-30-018	150	100	3000	1.8	491,000	661,000
FUL-EG-20100-30-018	FUL-HDG-20100-30-018	200	100	3000	1.8	516,000	693,000
FUL-EG-30100-30-018	FUL-HDG-30100-30-018	300	100	3000	1.8	563,000	757,000
FUL-EG-40100-30-018	FUL-HDG-40100-30-018	400	100	3000	1.8	609,000	820,000
FUL-EG-50100-30-018	FUL-HDG-50100-30-018	500	100	3000	1.8	656,000	883,000
FUL-EG-60100-30-018	FUL-HDG-60100-30-018	600	100	3000	1.8	704,000	946,000
FUL-EG-80100-30-018	FUL-HDG-80100-30-018	800	100	3000	1.8	916,000	1,227,000
FUL-EG-100100-30-018	FUL-HDG-100100-30-018	1000	100	3000	1.8	1,025,000	1,373,000

Cover U - Ladder

Type		Size (mm)		Price (Rp)	
Electro Galvanize	Hotdip Galvanize	Width	thicknes	Electro GV	Hotdip GV
FCLU-EG-100-018	FCLU-HDG-100-018	100	1.8	209,000	283,000
FCLU-EG-150-018	FCLU-HDG-150-018	150	1.8	295,000	396,000
FCLU-EG-200-018	FCLU-HDG-200-018	200	1.8	380,000	510,000
FCLU-EG-300-018	FCLU-HDG-300-018	300	1.8	549,000	738,000
FCLU-EG-400-018	FCLU-HDG-400-018	400	1.8	720,000	965,000
FCLU-EG-500-018	FCLU-HDG-500-018	500	1.8	888,000	1,195,000
FCLU-EG-600-018	FCLU-HDG-600-018	600	1.8	1,058,000	1,422,000
FCLU-EG-800-018	FCLU-HDG-800-018	800	1.8	1,398,000	1,878,000
FCLU-EG-1000-018	FCLU-HDG-1000-018	1000	1.8	1,737,000	2,335,000

CABLE LADDER



W - Ladder

Specification :

* Material : Hot Rolled Miled Steel Sheet (SPHC)

* Thickness : 1.8mm

* Plating : Electro Galvanize / Hotdip Galvanize

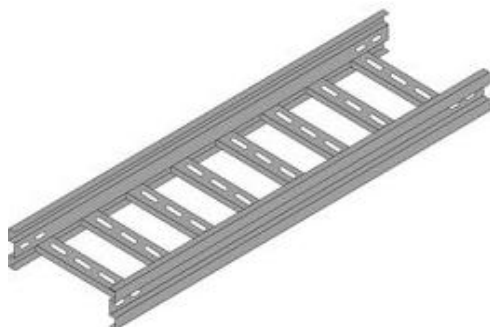

Type		Size (mm)				Price (Rp)	
Electro Galvanize	Hotdip Galvanize	Width	Height	Length	Thickness	Electro GV	Hotdip GV
FWL-EG-10100-30-018	FWL-HDG-10100-30-018	100	100	3000	1.8	574,000	772,000
FWL-EG-15100-30-018	FWL-HDG-15100-30-018	150	100	3000	1.8	598,000	804,000
FWL-EG-20100-30-018	FWL-HDG-20100-30-018	200	100	3000	1.8	622,000	836,000
FWL-EG-30100-30-018	FWL-HDG-30100-30-018	300	100	3000	1.8	669,000	899,000
FWL-EG-40100-30-018	FWL-HDG-40100-30-018	400	100	3000	1.8	716,000	963,000
FWL-EG-50100-30-018	FWL-HDG-50100-30-018	500	100	3000	1.8	764,000	1,026,000
FWL-EG-60100-30-018	FWL-HDG-60100-30-018	600	100	3000	1.8	810,000	1,089,000
FWL-EG-80100-30-018	FWL-HDG-80100-30-018	800	100	3000	1.8	1,036,000	1,391,000
FWL-EG-100100-30-018	FWL-HDG-100100-30-018	1000	100	3000	1.8	1,146,000	1,535,000

Cover W - Ladder

Type		Size (mm)		Price (Rp)	
Electro Galvanize	Hotdip Galvanize	Width	Thickness	Electro GV	Hotdip GV
FCLW-EG-100-018	FCLW-HDG-100-018	100	1.8	209,000	283,000
FCLW-EG-150-018	FCLW-HDG-150-018	150	1.8	295,000	396,000
FCLW-EG-200-018	FCLW-HDG-200-018	200	1.8	380,000	510,000
FCLW-EG-300-018	FCLW-HDG-300-018	300	1.8	549,000	738,000
FCLW-EG-400-018	FCLW-HDG-400-018	400	1.8	720,000	965,000
FCLW-EG-500-018	FCLW-HDG-500-018	500	1.8	888,000	1,195,000
FCLW-EG-600-018	FCLW-HDG-600-018	600	1.8	1,058,000	1,422,000
FCLW-EG-800-018	FCLW-HDG-800-018	800	1.8	1,398,000	1,878,000
FCLW-EG-1000-018	FCLW-HDG-1000-018	1000	1.8	1,737,000	2,335,000

CABLE LADDER

Horizontal Elbow U - Ladder



Specification :

* Material : Hot Rolled Miled Steel Sheet (SPHC)

* Thickness : 1.8mm

* Radius : 300mm

* Bend Angel : 90 degree

* Plating : Electro Galvanize / Hotdip Galvanize



Elbow U - Ladder

Type		Size (mm)			Price (Rp)	
Electro Galvanize	Hotdip Galvanize	Width	Height	Thickness	Electro GV	Hotdip GV
FLUL-EG-10100-018	FLUL-HDG-10100-018	100	100	1.8	154,000	213,000
FLUL-EG-15100-018	FLUL-HDG-15100-018	150	100	1.8	174,000	238,000
FLUL-EG-20100-018	FLUL-HDG-20100-018	200	100	1.8	192,000	261,000
FLUL-EG-30100-018	FLUL-HDG-30100-018	300	100	1.8	228,000	313,000
FLUL-EG-40100-018	FLUL-HDG-40100-018	400	100	1.8	286,000	391,000
FLUL-EG-50100-018	FLUL-HDG-50100-018	500	100	1.8	329,000	450,000
FLUL-EG-60100-018	FLUL-HDG-60100-018	600	100	1.8	405,000	556,000
FLUL-EG-80100-018	FLUL-HDG-80100-018	800	100	1.8	648,000	850,000
FLUL-EG-100100-018	FLUL-HDG-100100-018	1000	100	1.8	780,000	1,024,000

Cover Elbow U - Ladder

Type		Size (mm)		Price (Rp)	
Electro Galvanize	Hotdip Galvanize	Width	Thickness	Electro GV	Hotdip GV
FCEL-EG-100-018	FCEL-HDG-100-018	100	1.8	127,000	158,000
FCEL-EG-150-018	FCEL-HDG-150-018	150	1.8	160,000	203,000
FCEL-EG-200-018	FCEL-HDG-200-018	200	1.8	196,000	252,000
FCEL-EG-300-018	FCEL-HDG-300-018	300	1.8	283,000	368,000
FCEL-EG-400-018	FCEL-HDG-400-018	400	1.8	383,000	506,000
FCEL-EG-500-018	FCEL-HDG-500-018	500	1.8	500,000	664,000
FCEL-EG-600-018	FCEL-HDG-600-018	600	1.8	632,000	843,000
FCEL-EG-800-018	FCEL-HDG-800-018	800	1.8	940,000	1,263,000
FCEL-EG-1000-018	FCEL-HDG-1000-018	1000	1.8	1,310,000	1,764,000

CABLE LADDER



Horizontal Elbow W - Ladder

Specification :

- * Material : Hot Rolled Miled Steel Sheet (SPHC)
- * Thickness : 1.8mm
- * Radius : 300mm
- * Bend Angel : 90 degree
- * Plating : Electro Galvanize / Hotdip Galvanize



Elbow W - Ladder

Type		Size (mm)			Price (Rp)	
Electro Galvanize	Hotdip Galvanize	Width	Height	Thickness	Electro GV	Hotdip GV
FLWL-EG-10100-018	FLWL-HDG-10100-018	100	100	1.8	158,000	218,000
FLWL-EG-15100-018	FLWL-HDG-15100-018	150	100	1.8	178,000	243,000
FLWL-EG-20100-018	FLWL-HDG-20100-018	200	100	1.8	196,000	267,000
FLWL-EG-30100-018	FLWL-HDG-30100-018	300	100	1.8	234,000	320,000
FLWL-EG-40100-018	FLWL-HDG-40100-018	400	100	1.8	293,000	401,000
FLWL-EG-50100-018	FLWL-HDG-50100-018	500	100	1.8	337,000	462,000
FLWL-EG-60100-018	FLWL-HDG-60100-018	600	100	1.8	415,000	570,000
FLWL-EG-80100-018	FLWL-HDG-80100-018	800	100	1.8	664,000	872,000
FLWL-EG-100100-018	FLWL-HDG-100100-018	1000	100	1.8	799,000	1,050,000

Cover Elbow W - Ladder

Type		Size (mm)		Price (Rp)	
Electro Galvanize	Hotdip Galvanize	Width	Thickness	Electro GV	Hotdip GV
FCEL-EG-100-018	FCEL-HDG-100-018	100	1.8	127,000	158,000
FCEL-EG-150-018	FCEL-HDG-150-018	150	1.8	160,000	203,000
FCEL-EG-200-018	FCEL-HDG-200-018	200	1.8	196,000	252,000
FCEL-EG-300-018	FCEL-HDG-300-018	300	1.8	283,000	368,000
FCEL-EG-400-018	FCEL-HDG-400-018	400	1.8	383,000	506,000
FCEL-EG-500-018	FCEL-HDG-500-018	500	1.8	500,000	664,000
FCEL-EG-600-018	FCEL-HDG-600-018	600	1.8	632,000	843,000
FCEL-EG-800-018	FCEL-HDG-800-018	800	1.8	940,000	1,263,000
FCEL-EG-1000-018	FCEL-HDG-1000-018	1000	1.8	1,310,000	1,764,000

CABLE LADDER

Horizontal Diagonal U - Ladder



Specification :

- * Material : Hot Rolled Miled Steel Sheet (SPHC)
- * Thickness : 1.8mm
- * Radius : 300mm
- * Bend Angel : 90 degree
- * Plating : Electro Galvanize / Hotdip Galvanize



Diagonal U - Ladder

Type		Size (mm)			Price (Rp)	
Electro Galvanize	Hotdip Galvanize	Width	Height	Thickness	Electro GV	Hotdip GV
FDUL-EG-10100-018	FDUL-HDG-10100-018	100	100	1.8	154,000	213,000
FDUL-EG-15100-018	FDUL-HDG-15100-018	150	100	1.8	174,000	238,000
FDUL-EG-20100-018	FDUL-HDG-20100-018	200	100	1.8	192,000	261,000
FDUL-EG-30100-018	FDUL-HDG-30100-018	300	100	1.8	228,000	313,000
FDUL-EG-40100-018	FDUL-HDG-40100-018	400	100	1.8	286,000	391,000
FDUL-EG-50100-018	FDUL-HDG-50100-018	500	100	1.8	329,000	450,000
FDUL-EG-60100-018	FDUL-HDG-60100-018	600	100	1.8	405,000	556,000
FDUL-EG-80100-018	FDUL-HDG-80100-018	800	100	1.8	648,000	850,000
FDUL-EG-100100-018	FDUL-HDG-100100-018	1000	100	1.8	780,000	1,024,000

Cover Diagonal U - Ladder

Type		Size (mm)		Price (Rp)	
Electro Galvanize	Hotdip Galvanize	Width	Thickness	Electro GV	Hotdip GV
FCDL-EG-100-018	FCDL-HDG-100-018	100	1.8	209,000	283,000
FCDL-EG-150-018	FCDL-HDG-150-018	150	1.8	295,000	396,000
FCDL-EG-200-018	FCDL-HDG-200-018	200	1.8	380,000	510,000
FCDL-EG-300-018	FCDL-HDG-300-018	300	1.8	549,000	738,000
FCDL-EG-400-018	FCDL-HDG-400-018	400	1.8	720,000	965,000
FCDL-EG-500-018	FCDL-HDG-500-018	500	1.8	888,000	1,195,000
FCDL-EG-600-018	FCDL-HDG-600-018	600	1.8	1,058,000	1,422,000
FCDL-EG-800-018	FCDL-HDG-800-018	800	1.8	1,398,000	1,878,000
FCDL-EG-1000-018	FCDL-HDG-1000-018	1000	1.8	1,737,000	2,335,000

CABLE LADDER



Horizontal Diagonal W - Ladder

Specification :

- * Material : Hot Rolled Miled Steel Sheet (SPHC)
- * Thickness : 1.8mm
- * Radius : 300mm
- * Bend Angel : 90 degree
- * Plating : Electro Galvanize / Hotdip Galvanize



Diagonal W - Ladder

Type		Size (mm)			Price (Rp)	
Electro Galvanize	Hotdip Galvanize	Width	Height	Thickness	Electro GV	Hotdip GV
FDWL-EG-1050-018	FDWL-HDG-1050-018	100	50	1.8	158,000	218,000
FDWL-EG-1550-018	FDWL-HDG-1550-018	150	50	1.8	178,000	243,000
FDWL-EG-2050-018	FDWL-HDG-2050-018	200	50	1.8	196,000	267,000
FDWL-EG-3050-018	FDWL-HDG-3050-018	300	50	1.8	234,000	320,000
FDWL-EG-4050-018	FDWL-HDG-4050-018	400	50	1.8	293,000	401,000
FDWL-EG-5050-018	FDWL-HDG-5050-018	500	50	1.8	337,000	462,000
FDWL-EG-6050-018	FDWL-HDG-6050-018	600	50	1.8	415,000	570,000
FDWL-EG-8050-018	FDWL-HDG-8050-018	800	50	1.8	664,000	872,000
FDWL-EG-10050-018	FDWL-HDG-10050-018	1000	50	1.8	799,000	1,050,000

Cover Diagonal W - Ladder

Type		Size (mm)		Price (Rp)	
Electro Galvanize	Hotdip Galvanize	Width	Thickness	Electro GV	Hotdip GV
FCDL-EG-100-018	FCDL-HDG-100-018	100	1.8	209,000	283,000
FCDL-EG-150-018	FCDL-HDG-150-018	150	1.8	295,000	396,000
FCDL-EG-200-018	FCDL-HDG-200-018	200	1.8	380,000	510,000
FCDL-EG-300-018	FCDL-HDG-300-018	300	1.8	549,000	738,000
FCDL-EG-400-018	FCDL-HDG-400-018	400	1.8	720,000	965,000
FCDL-EG-500-018	FCDL-HDG-500-018	500	1.8	888,000	1,195,000
FCDL-EG-600-018	FCDL-HDG-600-018	600	1.8	1,058,000	1,422,000
FCDL-EG-800-018	FCDL-HDG-800-018	800	1.8	1,398,000	1,878,000
FCDL-EG-1000-018	FCDL-HDG-1000-018	1000	1.8	1,737,000	2,335,000

CABLE LADDER

Horizontal Tee U - Ladder



Specification :

- * Material : Hot Rolled Miled Steel Sheet (SPHC)
- * Thickness : 1.8mm
- * Radius : 300mm
- * Bend Angel : 90 degree
- * Plating : Electro Galvanize / Hotdip Galvanize



Horizontal Tee U - Ladder

Type		Size (mm)			Price (Rp)	
Electro Galvanize	Hotdip Galvanize	Width	Height	Thickness	Electro GV	Hotdip GV
FTUL-EG-10100-018	FTUL-HDG-10100-018	100	100	1.8	245,000	336,000
FTUL-EG-15100-018	FTUL-HDG-15100-018	150	100	1.8	265,000	364,000
FTUL-EG-20100-018	FTUL-HDG-20100-018	200	100	1.8	286,000	391,000
FTUL-EG-30100-018	FTUL-HDG-30100-018	300	100	1.8	327,000	448,000
FTUL-EG-40100-018	FTUL-HDG-40100-018	400	100	1.8	368,000	505,000
FTUL-EG-50100-018	FTUL-HDG-50100-018	500	100	1.8	439,000	602,000
FTUL-EG-60100-018	FTUL-HDG-60100-018	600	100	1.8	486,000	667,000
FTUL-EG-80100-018	FTUL-HDG-80100-018	800	100	1.8	662,000	873,000
FTUL-EG-100100-018	FTUL-HDG-100100-018	1000	100	1.8	772,000	1,014,000

Cover Tee U - Ladder

Type		Size (mm)		Price (Rp)	
Electro Galvanize	Hotdip Galvanize	Width	Thickness	Electro GV	Hotdip GV
FCTUL-EG-100-018	FCTUL-HDG-100-018	100	1.8	216,000	264,000
FCTUL-EG-150-018	FCTUL-HDG-150-018	150	1.8	261,000	325,000
FCTUL-EG-200-018	FCTUL-HDG-200-018	200	1.8	308,000	391,000
FCTUL-EG-300-018	FCTUL-HDG-300-018	300	1.8	416,000	539,000
FCTUL-EG-400-018	FCTUL-HDG-400-018	400	1.8	540,000	704,000
FCTUL-EG-500-018	FCTUL-HDG-500-018	500	1.8	678,000	893,000
FCTUL-EG-600-018	FCTUL-HDG-600-018	600	1.8	832,000	1,103,000
FCTUL-EG-800-018	FCTUL-HDG-800-018	800	1.8	1,188,000	1,584,000
FCTUL-EG-1000-018	FCTUL-HDG-1000-018	1000	1.8	1,604,000	2,147,000

CABLE LADDER



Horizontal Tee W - Ladder

Specification :

- * Material : Hot Rolled Miled Steel Sheet (SPHC)
- * Thickness : 1.8mm
- * Radius : 300mm
- * Bend Angel : 90 degree
- * Plating : Electro Galvanize / Hotdip Galvanize

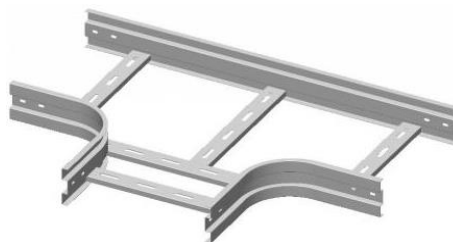

Horizontal Tee W - Ladder

Type		Size (mm)			Price (Rp)	
Electro Galvanize	Hotdip Galvanize	Width	Height	Thickness	Electro GV	Hotdip GV
FTWL-EG-10100-018	FTWL-HDG-10100-018	100	100	1.8	251,000	344,000
FTWL-EG-15100-018	FTWL-HDG-15100-018	150	100	1.8	271,000	373,000
FTWL-EG-20100-018	FTWL-HDG-20100-018	200	100	1.8	293,000	401,000
FTWL-EG-30100-018	FTWL-HDG-30100-018	300	100	1.8	335,000	459,000
FTWL-EG-40100-018	FTWL-HDG-40100-018	400	100	1.8	377,000	517,000
FTWL-EG-50100-018	FTWL-HDG-50100-018	500	100	1.8	450,000	617,000
FTWL-EG-60100-018	FTWL-HDG-60100-018	600	100	1.8	498,000	684,000
FTWL-EG-80100-018	FTWL-HDG-80100-018	800	100	1.8	678,000	894,000
FTWL-EG-100100-018	FTWL-HDG-100100-018	1000	100	1.8	791,000	1,040,000

Cover Tee W - Ladder

Type		Size (mm)		Price (Rp)	
Electro Galvanize	Hotdip Galvanize	Width	Thickness	Electro GV	Hotdip GV
FCTUL-EG-100-018	FCTUL-HDG-100-018	100	1.8	216,000	264,000
FCTUL-EG-150-018	FCTUL-HDG-150-018	150	1.8	261,000	325,000
FCTUL-EG-200-018	FCTUL-HDG-200-018	200	1.8	308,000	391,000
FCTUL-EG-300-018	FCTUL-HDG-300-018	300	1.8	416,000	539,000
FCTUL-EG-400-018	FCTUL-HDG-400-018	400	1.8	540,000	704,000
FCTUL-EG-500-018	FCTUL-HDG-500-018	500	1.8	678,000	893,000
FCTUL-EG-600-018	FCTUL-HDG-600-018	600	1.8	832,000	1,103,000
FCTUL-EG-800-018	FCTUL-HDG-800-018	800	1.8	1,188,000	1,584,000
FCTUL-EG-1000-018	FCTUL-HDG-1000-018	1000	1.8	1,604,000	2,147,000

CABLE LADDER



Horizontal Cross U - Ladder

Specification :

- * Material : Hot Rolled Miled Steel Sheet (SPHC)
- * Thickness : 1.8mm
- * Radius : 300mm
- * Bend Angel : 90 degree
- * Plating : Electro Galvanize / Hotdip Galvanize



Horizontal Cross U - Ladder

Type		Size (mm)			Price (Rp)	
Electro Galvanize	Hotdip Galvanize	Width	Height	Thickness	Electro GV	Hotdip GV
FCUL-EG-10100-018	FCUL-HDG-10100-018	100	100	1.8	320,000	438,000
FCUL-EG-15100-018	FCUL-HDG-15100-018	150	100	1.8	343,000	471,000
FCUL-EG-20100-018	FCUL-HDG-20100-018	200	100	1.8	368,000	503,000
FCUL-EG-30100-018	FCUL-HDG-30100-018	300	100	1.8	415,000	570,000
FCUL-EG-40100-018	FCUL-HDG-40100-018	400	100	1.8	463,000	635,000
FCUL-EG-50100-018	FCUL-HDG-50100-018	500	100	1.8	511,000	702,000
FCUL-EG-60100-018	FCUL-HDG-60100-018	600	100	1.8	559,000	767,000
FCUL-EG-80100-018	FCUL-HDG-80100-018	800	100	1.8	747,000	985,000
FCUL-EG-100100-018	FCUL-HDG-100100-018	1000	100	1.8	858,000	1,129,000

Cover Cross U - Ladder

Type		Size (mm)		Price (Rp)	
Electro Galvanize	Hotdip Galvanize	Width	Thickness	Electro GV	Hotdip GV
FCCUL-EG-100-018	FCCUL-HDG-100-018	100	1.8	297,000	440,000
FCCUL-EG-150-018	FCCUL-HDG-150-018	150	1.8	423,000	515,000
FCCUL-EG-200-018	FCCUL-HDG-200-018	200	1.8	479,000	597,000
FCCUL-EG-300-018	FCCUL-HDG-300-018	300	1.8	613,000	773,000
FCCUL-EG-400-018	FCCUL-HDG-400-018	400	1.8	757,000	971,000
FCCUL-EG-500-018	FCCUL-HDG-500-018	500	1.8	918,000	1,191,000
FCCUL-EG-600-018	FCCUL-HDG-600-018	600	1.8	1,095,000	1,431,000
FCCUL-EG-800-018	FCCUL-HDG-800-018	800	1.8	1,493,000	1,972,000
FCCUL-EG-1000-018	FCCUL-HDG-1000-018	1000	1.8	1,953,000	2,596,000

CABLE LADDER



Horizontal Cross W - Ladder

Specification :

- * Material : Hot Rolled Miled Steel Sheet (SPHC)
- * Thickness : 1.8mm
- * Radius : 300mm
- * Bend Angel : 90 degree
- * Plating : Electro Galvanize / Hotdip Galvanize

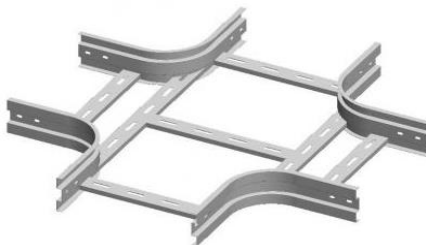

Horizontal Cross W - Ladder

Type		Size (mm)			Price (Rp)	
Electro Galvanize	Hotdip Galvanize	Width	Height	Thickness	Electro GV	Hotdip GV
FCWL-EG-10100-018	FCWL-HDG-10100-018	100	100	1.8	328,000	449,000
FCWL-EG-15100-018	FCWL-HDG-15100-018	150	100	1.8	352,000	483,000
FCWL-EG-20100-018	FCWL-HDG-20100-018	200	100	1.8	377,000	516,000
FCWL-EG-30100-018	FCWL-HDG-30100-018	300	100	1.8	425,000	584,000
FCWL-EG-40100-018	FCWL-HDG-40100-018	400	100	1.8	474,000	651,000
FCWL-EG-50100-018	FCWL-HDG-50100-018	500	100	1.8	523,000	719,000
FCWL-EG-60100-018	FCWL-HDG-60100-018	600	100	1.8	572,000	786,000
FCWL-EG-80100-018	FCWL-HDG-80100-018	800	100	1.8	765,000	1,009,000
FCWL-EG-100100-018	FCWL-HDG-100100-018	1000	100	1.8	879,000	1,157,000

Cover Cross W - Ladder

Type		Size (mm)		Price (Rp)	
Electro Galvanize	Hotdip Galvanize	Width	Thickness	Electro GV	Hotdip GV
FCCWL-EG-100-018	FCCWL-HDG-100-018	100	1.8	297,000	440,000
FCCWL-EG-150-018	FCCWL-HDG-150-018	150	1.8	423,000	515,000
FCCWL-EG-200-018	FCCWL-HDG-200-018	200	1.8	479,000	597,000
FCCWL-EG-300-018	FCCWL-HDG-300-018	300	1.8	613,000	773,000
FCCWL-EG-400-018	FCCWL-HDG-400-018	400	1.8	757,000	971,000
FCCWL-EG-500-018	FCCWL-HDG-500-018	500	1.8	918,000	1,191,000
FCCWL-EG-600-018	FCCWL-HDG-600-018	600	1.8	1,095,000	1,431,000
FCCWL-EG-800-018	FCCWL-HDG-800-018	800	1.8	1,493,000	1,972,000
FCCWL-EG-1000-018	FCCWL-HDG-1000-018	1000	1.8	1,953,000	2,596,000

CABLE LADDER



Vertical Riser U - Ladder

Specification :

* Material : Hot Rolled Miled Steel Sheet (SPHC)

* Thickness : 1.8mm

* Radius : 300mm

* Bend Angel : 90 degree

* Plating : Electro Galvanize / Hotdip Galvanize



INSIDE RISER



OUTSIDE RISER

Vertical Inside Riser U - Ladder

Type		Size (mm)			Price (Rp)	
Electro Galvanize	Hotdip Galvanize	Width	Height	Thickness	Electro GV	Hotdip GV
FIRUL-EG-10100-018	FIRUL-HDG-10100-018	100	100	1.8	183,000	250,000
FIRUL-EG-15100-018	FIRUL-HDG-15100-018	150	100	1.8	192,000	263,000
FIRUL-EG-20100-018	FIRUL-HDG-20100-018	200	100	1.8	201,000	274,000
FIRUL-EG-30100-018	FIRUL-HDG-30100-018	300	100	1.8	218,000	299,000
FIRUL-EG-40100-018	FIRUL-HDG-40100-018	400	100	1.8	237,000	325,000
FIRUL-EG-50100-018	FIRUL-HDG-50100-018	500	100	1.8	255,000	348,000
FIRUL-EG-60100-018	FIRUL-HDG-60100-018	600	100	1.8	272,000	373,000
FIRUL-EG-80100-018	FIRUL-HDG-80100-018	800	100	1.8	352,000	463,000
FIRUL-EG-100100-018	FIRUL-HDG-100100-018	1000	100	1.8	394,000	516,000

Vertical Outside Riser U - Ladder

Type		Size (mm)			Price (Rp)	
Electro Galvanize	Hotdip Galvanize	Width	Height	Thickness	Electro GV	Hotdip GV
FORUL-EG-10100-018	FORUL-HDG-10100-018	100	100	1.8	183,000	250,000
FORUL-EG-15100-018	FORUL-HDG-15100-018	150	100	1.8	192,000	263,000
FORUL-EG-20100-018	FORUL-HDG-20100-018	200	100	1.8	201,000	274,000
FORUL-EG-30100-018	FORUL-HDG-30100-018	300	100	1.8	218,000	299,000
FORUL-EG-40100-018	FORUL-HDG-40100-018	400	100	1.8	237,000	325,000
FORUL-EG-50100-018	FORUL-HDG-50100-018	500	100	1.8	255,000	348,000
FORUL-EG-60100-018	FORUL-HDG-60100-018	600	100	1.8	272,000	373,000
FORUL-EG-80100-018	FORUL-HDG-80100-018	800	100	1.8	352,000	463,000
FORUL-EG-100100-018	FORUL-HDG-100100-018	1000	100	1.8	394,000	516,000

CABLE LADDER



Vertical Riser W - Ladder

Specification :

- * Material : Hot Rolled Miled Steel Sheet (SPHC)
- * Thickness : 1.8mm
- * Radius : 300mm
- * Bend Angel : 90 degree
- * Plating : Electro Galvanize / Hotdip Galvanize



INSIDE RISER



OUTSIDE RISER

Vertical Inside Riser W - Ladder

Type		Size (mm)			Price (Rp)	
Electro Galvanize	Hotdip Galvanize	Width	Height	Thickness	Electro GV	Hotdip GV
FIRWL-EG-10100-018	FIRWL-HDG-10100-018	100	100	1.8	187,000	256,000
FIRWL-EG-15100-018	FIRWL-HDG-15100-018	150	100	1.8	196,000	270,000
FIRWL-EG-20100-018	FIRWL-HDG-20100-018	200	100	1.8	205,000	281,000
FIRWL-EG-30100-018	FIRWL-HDG-30100-018	300	100	1.8	224,000	307,000
FIRWL-EG-40100-018	FIRWL-HDG-40100-018	400	100	1.8	243,000	333,000
FIRWL-EG-50100-018	FIRWL-HDG-50100-018	500	100	1.8	261,000	357,000
FIRWL-EG-60100-018	FIRWL-HDG-60100-018	600	100	1.8	279,000	382,000
FIRWL-EG-80100-018	FIRWL-HDG-80100-018	800	100	1.8	361,000	474,000
FIRWL-EG-100100-018	FIRWL-HDG-100100-018	1000	100	1.8	403,000	529,000

Vertical Outside Riser W - Ladder

Type		Size (mm)			Price (Rp)	
Electro Galvanize	Hotdip Galvanize	Width	Height	Thickness	Electro GV	Hotdip GV
FORWL-EG-10100-018	FORWL-HDG-10100-018	100	100	1.8	187,000	256,000
FORWL-EG-15100-018	FORWL-HDG-15100-018	150	100	1.8	196,000	270,000
FORWL-EG-20100-018	FORWL-HDG-20100-018	200	100	1.8	205,000	281,000
FORWL-EG-30100-018	FORWL-HDG-30100-018	300	100	1.8	224,000	307,000
FORWL-EG-40100-018	FORWL-HDG-40100-018	400	100	1.8	243,000	333,000
FORWL-EG-50100-018	FORWL-HDG-50100-018	500	100	1.8	261,000	357,000
FORWL-EG-60100-018	FORWL-HDG-60100-018	600	100	1.8	279,000	382,000
FORWL-EG-80100-018	FORWL-HDG-80100-018	800	100	1.8	361,000	474,000
FORWL-EG-100100-018	FORWL-HDG-100100-018	1000	100	1.8	403,000	529,000

CABLE LADDER



Cover Vertical Riser - Ladder

Specification :

- * Material : Hot Rolled Miled Steel Sheet (SPHC)
- * Thickness : 1.8mm
- * Radius : 300mm
- * Bend Angel : 90 degree
- * Plating : Electro Galvanize / Hotdip Galvanize



INSIDE RISER



OUTSIDE RISER

Cover Vertical Inside Riser U & W - Ladder

Type		Size (mm)		Price (Rp)	
Electro Galvanize	Hotdip Galvanize	Width	Thickness	Electro GV	Hotdip GV
FCIRL-EG-100-018	FCIRL-HDG-100-018	100	1.8	54,000	74,000
FCIRL-EG-150-018	FCIRL-HDG-150-018	150	1.8	76,000	103,000
FCIRL-EG-200-018	FCIRL-HDG-200-018	200	1.8	98,000	132,000
FCIRL-EG-300-018	FCIRL-HDG-300-018	300	1.8	140,000	190,000
FCIRL-EG-400-018	FCIRL-HDG-400-018	400	1.8	184,000	249,000
FCIRL-EG-500-018	FCIRL-HDG-500-018	500	1.8	226,000	307,000
FCIRL-EG-600-018	FCIRL-HDG-600-018	600	1.8	270,000	366,000
FCIRL-EG-800-018	FCIRL-HDG-800-018	800	1.8	355,000	482,000
FCIRL-EG-1000-018	FCIRL-HDG-1000-018	1000	1.8	442,000	598,000

Cover Vertical Outside Riser U & W - Ladder

Type		Size (mm)		Price (Rp)	
Electro Galvanize	Hotdip Galvanize	Width	Thickness	Electro GV	Hotdip GV
FCORL-EG-100-018	FCORL-HDG-100-018	100	1.8	70,000	93,000
FCORL-EG-150-018	FCORL-HDG-150-018	150	1.8	97,000	129,000
FCORL-EG-200-018	FCORL-HDG-200-018	200	1.8	121,000	167,000
FCORL-EG-300-018	FCORL-HDG-300-018	300	1.8	176,000	238,000
FCORL-EG-400-018	FCORL-HDG-400-018	400	1.8	230,000	312,000
FCORL-EG-500-018	FCORL-HDG-500-018	500	1.8	284,000	386,000
FCORL-EG-600-018	FCORL-HDG-600-018	600	1.8	339,000	459,000
FCORL-EG-800-018	FCORL-HDG-800-018	800	1.8	447,000	607,000
FCORL-EG-1000-018	FCORL-HDG-1000-018	1000	1.8	556,000	752,000

CABLE LADDER



Reducer U - Ladder

Specification :

* Material : Hot Rolled Miled Steel Sheet (SPHC)

* Thickness : 1.8mm

* Length : 600mm

* Plating : Electro Galvanize / Hotdip Galvanize

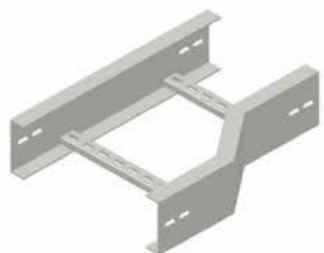

LEFT REDUCER



RIGHT REDUCER



STRAIGHT REDUCER

Reducer U - Ladder

Type		Size (mm)			Price (Rp)	
Electro Galvanize	Hotdip Galvanize	Width	Height	Thickness	Electro GV	Hotdip GV
FRUL-EG-1550-018	FRUL-HDG-1550-018	150	100	1.8	150,000	206,000
FRUL-EG-2050-018	FRUL-HDG-2050-018	200	100	1.8	156,000	214,000
FRUL-EG-3050-018	FRUL-HDG-3050-018	300	100	1.8	167,000	228,000
FRUL-EG-4050-018	FRUL-HDG-4050-018	400	100	1.8	179,000	245,000
FRUL-EG-5050-018	FRUL-HDG-5050-018	500	100	1.8	192,000	261,000
FRUL-EG-6050-018	FRUL-HDG-6050-018	600	100	1.8	202,000	278,000
FRUL-EG-8050-018	FRUL-HDG-8050-018	800	100	1.8	255,000	335,000
FRUL-EG-10050-018	FRUL-HDG-10050-018	1000	100	1.8	283,000	372,000

Cover Reducer U - Ladder

Type		Size (mm)		Price (Rp)	
Electro Galvanize	Hotdip Galvanize	Width	Thickness	Electro GV	Hotdip GV
FRCLU-EG-150-018	FRCLU-HDG-150-018	150	1.8	84,000	114,000
FRCLU-EG-200-018	FRCLU-HDG-200-018	200	1.8	107,000	144,000
FRCLU-EG-300-018	FRCLU-HDG-300-018	300	1.8	152,000	208,000
FRCLU-EG-400-018	FRCLU-HDG-400-018	400	1.8	199,000	270,000
FRCLU-EG-500-018	FRCLU-HDG-500-018	500	1.8	244,000	331,000
FRCLU-EG-600-018	FRCLU-HDG-600-018	600	1.8	289,000	395,000
FRCLU-EG-800-018	FRCLU-HDG-800-018	800	1.8	383,000	520,000
FRCLU-EG-1000-018	FRCLU-HDG-1000-018	1000	1.8	474,000	645,000

CABLE LADDER

Reducer W - Ladder



Specification :

* Material : Hot Rolled Miled Steel Sheet (SPHC)

* Thickness : 1.8mm

* Length : 600mm

* Plating : Electro Galvanize / Hotdip Galvanize



LEFT REDUCER



RIGHT REDUCER

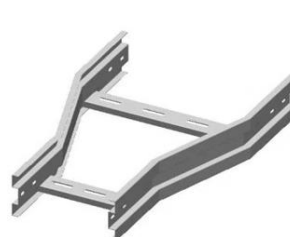

STRAIGHT REDUCER

Reducer W - Ladder

Type		Size (mm)			Price (Rp)	
Electro Galvanize	Hotdip Galvanize	Width	Height	Thickness	Electro GV	Hotdip GV
FRWL-EG-1550-018	FRWL-HDG-1550-018	150	100	1.8	154,000	211,000
FRWL-EG-2050-018	FRWL-HDG-2050-018	200	100	1.8	160,000	220,000
FRWL-EG-3050-018	FRWL-HDG-3050-018	300	100	1.8	171,000	233,000
FRWL-EG-4050-018	FRWL-HDG-4050-018	400	100	1.8	184,000	251,000
FRWL-EG-5050-018	FRWL-HDG-5050-018	500	100	1.8	196,000	267,000
FRWL-EG-6050-018	FRWL-HDG-6050-018	600	100	1.8	207,000	285,000
FRWL-EG-8050-018	FRWL-HDG-8050-018	800	100	1.8	261,000	343,000
FRWL-EG-10050-018	FRWL-HDG-10050-018	1000	100	1.8	289,000	381,000

Cover Reducer W - Ladder

Type		Size (mm)		Price (Rp)	
Electro Galvanize	Hotdip Galvanize	Width	Thickness	Electro GV	Hotdip GV
FRCLW-EG-150-018	FRCLW-HDG-150-018	150	1.8	84,000	114,000
FRCLW-EG-200-018	FRCLW-HDG-200-018	200	1.8	107,000	144,000
FRCLW-EG-300-018	FRCLW-HDG-300-018	300	1.8	152,000	208,000
FRCLW-EG-400-018	FRCLW-HDG-400-018	400	1.8	199,000	270,000
FRCLW-EG-500-018	FRCLW-HDG-500-018	500	1.8	244,000	331,000
FRCLW-EG-600-018	FRCLW-HDG-600-018	600	1.8	289,000	395,000
FRCLW-EG-800-018	FRCLW-HDG-800-018	800	1.8	383,000	520,000
FRCLW-EG-1000-018	FRCLW-HDG-1000-018	1000	1.8	474,000	645,000

CABLE TRAY & Ladder



Accessories Cable TRAY & Ladder

Specification :

* Material : Hot Rolled Miled Steel Sheet (SPHC)

* Thickness : 1.8mm

* Plating : Electro Galvanize / Hotdip Galvanize

Note : * Jointing Price Include bolts, nut, ring

Jointing U - TRAY

Type		Size (mm)	Price / pcs (Rp)	
Electro Galvanize	Hotdip Galvanize		Electro GV	Hotdip GV
JUT-EG-50	JUT-HDG-50	50	18,000	21,000
JUT-EG-100	JUT-HDG-100	100	26,000	33,000



Jointing C - TRAY

Type		Size (mm)	Price / pcs (Rp)	
Electro Galvanize	Hotdip Galvanize		Electro GV	Hotdip GV
JCT-EG-50	JCT-HDG-50	50	18,000	21,000
JCT-EG-100	JCT-HDG-100	100	26,000	33,000



Jointing U - Ladder

Type		Size (mm)	Price / pcs (Rp)	
Electro Galvanize	Hotdip Galvanize		Electro GV	Hotdip GV
JUL-EG-50	JUL-HDG-50	50	18,000	21,000
JUL-EG-100	JUL-HDG-100	100	26,000	33,000



Jointing W - Ladder

Type		Size (mm)	Price / pcs (Rp)	
Electro Galvanize	Hotdip Galvanize		Electro GV	Hotdip GV
JWL-EG-100	JWL-HDG-100	100	26,000	37,000



Stand Plate

Type		Size (mm)	Price / pcs (Rp)	
Electro Galvanize	Hotdip Galvanize		Electro GV	Hotdip GV
SPTL-EG-50	SPTL-HDG-50	50	43,000	46,600
SPTL-EG-100	SPTL-HDG-100	100	51,600	64,300

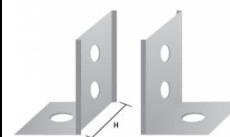

Wall Bracket

Type		Size (mm)	Price / pcs (Rp)	
Electro Galvanize	Hotdip Galvanize		Electro GV	Hotdip GV
WBTL-EG-50	WBTL-HDG-50	50	27,000	35,300
WBTL-EG-100	WBTL-HDG-100	100	36,100	46,600



CABLE TRAY & Ladder



Accessories Cable TRAY & Ladder

Specification :

* Material : Hot Rolled Miled Steel Sheet (SPHC)

* Thickness : 1.8mm

* Plating : Electro Galvanize / Hotdip Galvanize

Bracket

Type		Size (mm)	Price / pcs (Rp)	
Electro Galvanize	Hotdip Galvanize		Electro GV	Hotdip GV
FBTL-EG-50	FBTL-HDG-50	50	41,000	53,000
FBTL-EG-100	FBTL-HDG-100	100	56,000	71,000
FBTL-EG-150	FBTL-HDG-150	150	70,000	90,000
FBTL-EG-200	FBTL-HDG-200	200	85,000	108,000
FBTL-EG-250	FBTL-HDG-250	250	100,000	127,000
FBTL-EG-300	FBTL-HDG-300	300	114,000	145,000
FBTL-EG-400	FBTL-HDG-400	400	142,000	183,000
FBTL-EG-500	FBTL-HDG-500	500	172,000	220,000
FBTL-EG-600	FBTL-HDG-600	600	176,000	225,000
FBTL-EG-800	FBTL-HDG-800	800	199,000	254,000
FBTL-EG-1000	FBTL-HDG-1000	1000	238,000	303,000



Hanger Beam

Type		Size (mm)	Price / pcs (Rp)	
Electro Galvanize	Hotdip Galvanize		Electro GV	Hotdip GV
FHBTL-EG-50	FHBTL-HDG-50	50	17,000	21,000
FHBTL-EG-100	FHBTL-HDG-100	100	22,000	28,000
FHBTL-EG-150	FHBTL-HDG-150	150	30,000	37,000
FHBTL-EG-200	FHBTL-HDG-200	200	36,000	47,000
FHBTL-EG-250	FHBTL-HDG-250	250	44,000	54,000
FHBTL-EG-300	FHBTL-HDG-300	300	52,000	64,000
FHBTL-EG-400	FHBTL-HDG-400	400	58,000	72,000
FHBTL-EG-500	FHBTL-HDG-500	500	63,000	79,000
FHBTL-EG-600	FHBTL-HDG-600	600	80,000	100,000
FHBTL-EG-800	FHBTL-HDG-800	800	93,000	117,000
FHBTL-EG-1000	FHBTL-HDG-1000	1000	116,000	146,000

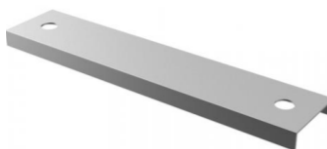

CABLE TRAY & Ladder



Accessories Cable TRAY & Ladder

Specification :

* Material : Hot Rolled Miled Steel Sheet (SPHC)

* Thickness : 1.8mm

* Plating : Electro Galvanize / Hotdip Galvanize

Hanger Rod

Type		Size	Price / pcs (Rp)	
Electro Galvanize	Hotdip Galvanize		Electro GV	Hotdip GV
HRTL-EG-3/8	HRTL-HDG-3/8	3/8" X 1M		



Hanger Clevis

Type		Size (mm)	Price / pcs (Rp)	
Electro Galvanize	Hotdip Galvanize		Electro GV	Hotdip GV
HCTL-EG-40	HCTL-HDG-40	40 X 45	31,000	40,000

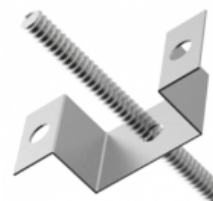

Hold Down Clamp

Type		Size (mm)	Price / pcs (Rp)	
Electro Galvanize	Hotdip Galvanize		Electro GV	Hotdip GV
HDTL-EG-50	HDTL-HDG-50	50	7,800	11,400
HDTL-EG-100	HDTL-HDG-100	100	11,700	14,000



Angel Connector

Type		Size (mm)	Price / pcs (Rp)	
Electro Galvanize	Hotdip Galvanize		Electro GV	Hotdip GV
ACTL-EG-50	ACTL-HDG-50	50	15,600	19,000
ACTL-EG-100	ACTL-HDG-100	100	22,000	28,000

