

PRICE LIST

CABLE TRAY & LADDER 1,2 mm

Spesifikasi

Tebal Plat 1,2mm

Panjang 2,4 meter

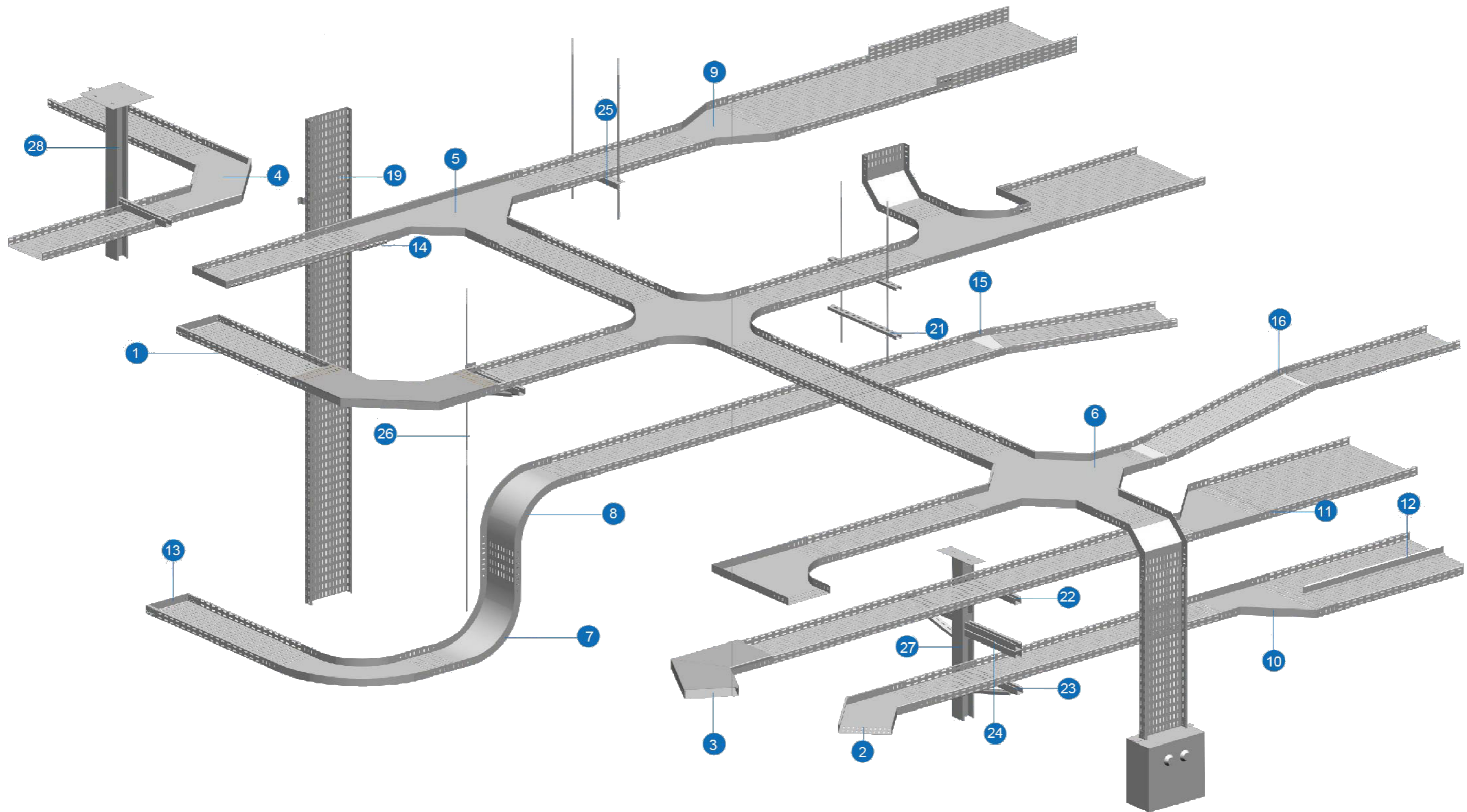

- 1 Perforated Cable Tray Straight (BC*)
- 2 Elbow 45° (BC*-E1)
- 3 Elbow 60° (BC*-E2)
- 4 Elbow 90° (BC*-E3)
- 5 Tee (BC*-T)
- 6 Cross (BC*-C)
- 7 Inside Riser (BC*-IR)

- 8 Outside Riser (BC*-OR)
- 9 Reducer (BC*-MR)
- 10 Right Hand Reducer (BC*-RR)
- 11 Left Hand Reducer (BC*-LR)
- 12 Divider (BC*-D)
- 13 Blind End (BC*-BE)
- 14 Straight Coupler (BC*-SC)

- 15 Horizontal Adjust Coupler (BC*-HAC)
- 16 Vertical Adjust Coupler (BC*-VAC)
- 17 Adjust Riser (BC*-AR)
- 18 Bolt & Nut (BN)
- 19 Under Floor Stand (UFS)
- 20 Cover Clamp (BC*-CLP)
- 21 Straight Bracket (SB)

- 22 Wall Bracket (WB)
- 23 Strengthen Bracket (STB)
- 24 Strengthening Bracket (STNB)
- 25 Angle Bar Bracket (ABB)
- 26 Treaded Rod (TR)
- 27 Ceiling Bracket (CB)
- 28 Strengthening Ceiling Bracket (SCB)

- 29 Flat Cover (BC-FSC)
- 30 Peak Cover (BC-PSC)
- 31 Elbow 45° Cover (BC-EFC)
- 32 Elbow 60° Cover (BC-ESC)
- 33 Elbow 90° Cover (BC-ENC)
- 34 Tee Cover (BC-TC)
- 35 Cross Cover (BC-CC)

- 36 Inside Riser Cover (BC-IRC)
- 37 Outside Riser Cover (BC-ORC)
- 38 Reducer Cover (BC-RC)
- 39 Right Hand Reducer Cover (BC-RRC)
- 40 Left Hand Reducer Cover (BC-LRC)

U - TRAY

Specification :

- * Material : Hot Rolled Miled Steel Sheet (SPHC)
- * Thickness : 1.2mm
- * Plating : Electro Galvanize / Hotdip Galvanize

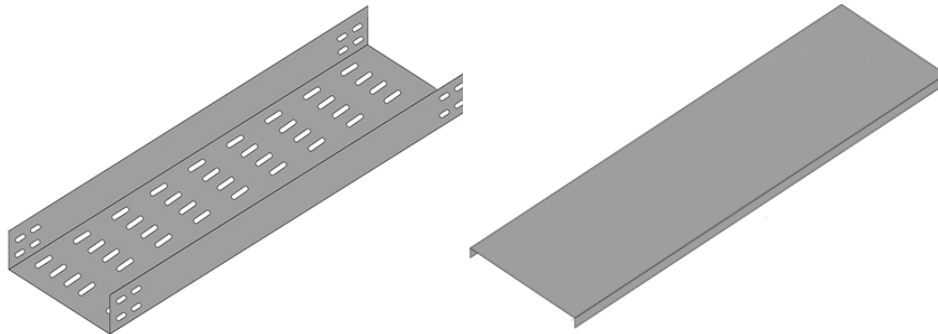

Type		Size (mm)				Price (Rp)	
Electro Galvanize	Hotdip Galvanize	Width	Height	Length	Thickness	Electro GV	Hotdip GV
FUCT-EG-0550-24-012	FUCT-HDG-0550-24-012	50	50	2400	1.2	142,000	207,000
FUCT-EG-1050-24-012	FUCT-HDG-1050-24-012	100	50	2400	1.2	190,000	276,000
FUCT-EG-1550-24-012	FUCT-HDG-1550-24-012	150	50	2400	1.2	238,000	345,000
FUCT-EG-2050-24-012	FUCT-HDG-2050-24-012	200	50	2400	1.2	285,000	414,000
FUCT-EG-2550-24-012	FUCT-HDG-2550-24-012	250	50	2400	1.2	333,000	484,000
FUCT-EG-3050-24-012	FUCT-HDG-3050-24-012	300	50	2400	1.2	381,000	554,000
FUCT-EG-4050-24-012	FUCT-HDG-4050-24-012	400	50	2400	1.2	476,000	692,000

Type		Size (mm)				Price (Rp)	
Electro Galvanize	Hotdip Galvanize	Width	Height	Length	Thickness	Electro GV	Hotdip GV
FUCT-EG-10100-24-012	FUCT-HDG-10100-24-012	100	100	24	1.2	285,000	414,000
FUCT-EG-15100-24-012	FUCT-HDG-15100-24-012	150	100	24	1.2	333,000	484,000
FUCT-EG-20100-24-012	FUCT-HDG-20100-24-012	200	100	24	1.2	381,000	554,000
FUCT-EG-25100-24-012	FUCT-HDG-25100-24-012	250	100	24	1.2	428,000	622,000
FUCT-EG-30100-24-012	FUCT-HDG-30100-24-012	300	100	24	1.2	476,000	692,000
FUCT-EG-40100-24-012	FUCT-HDG-40100-24-012	400	100	24	1.2	570,000	831,000

COVER TRAY - U & C

Type		Size (mm)			Price (Rp)	
Electro Galvanize	Hotdip Galvanize	Width	Length	Thickness	Electro GV	Hotdip GV
FCT-EG-50-24-012	FCT-HDG-50-24-012	50	2400	1.2	78,000	118,000
FCT-EG-100-24-012	FCT-HDG-100-24-012	100	2400	1.2	129,000	196,000
FCT-EG-150-24-012	FCT-HDG-150-24-012	150	2400	1.2	179,000	276,000
FCT-EG-200-24-012	FCT-HDG-200-24-012	200	2400	1.2	232,000	353,000
FCT-EG-250-24-012	FCT-HDG-250-24-012	250	2400	1.2	282,000	431,000
FCT-EG-300-24-012	FCT-HDG-300-24-012	300	2400	1.2	333,000	512,000
FCT-EG-400-24-012	FCT-HDG-400-24-012	400	2400	1.2	436,000	669,000

C - TRAY

Specification :

- * Material : Hot Rolled Miled Steel Sheet (SPHC)
- * Thickness : 1.2mm
- * Plating : Electro Galvanize / Hotdip Galvanize

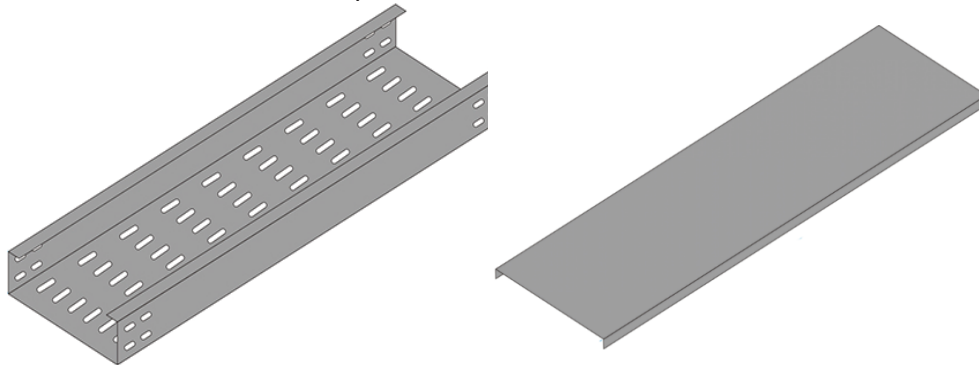

Type		Size (mm)				Price (Rp)	
Electro Galvanize	Hotdip Galvanize	Width	Height	Length	Thickness	Electro GV	Hotdip GV
FCCT-EG-0550-24-012	FCCT-HDG-0550-24-012	50	50	2400	1.2	159,000	230,000
FCCT-EG-1050-24-012	FCCT-HDG-1050-24-012	100	50	2400	1.2	204,000	299,000
FCCT-EG-1550-24-012	FCCT-HDG-1550-24-012	150	50	2400	1.2	252,000	369,000
FCCT-EG-2050-24-012	FCCT-HDG-2050-24-012	200	50	2400	1.2	302,000	437,000
FCCT-EG-2550-24-012	FCCT-HDG-2550-24-012	250	50	2400	1.2	347,000	507,000
FCCT-EG-3050-24-012	FCCT-HDG-3050-24-012	300	50	2400	1.2	395,000	576,000
FCCT-EG-4050-24-012	FCCT-HDG-4050-24-012	400	50	2400	1.2	490,000	713,000

Type		Size (mm)				Price (Rp)	
Electro Galvanize	Hotdip Galvanize	Width	Height	Length	Thickness	Electro GV	Hotdip GV
FCCT-EG-10100-24-012	FCCT-HDG-10100-24-012	100	100	2400	1.2	302,000	437,000
FCCT-EG-15100-24-012	FCCT-HDG-15100-24-012	150	100	2400	1.2	347,000	507,000
FCCT-EG-20100-24-012	FCCT-HDG-20100-24-012	200	100	2400	1.2	395,000	576,000
FCCT-EG-25100-24-012	FCCT-HDG-25100-24-012	250	100	2400	1.2	444,000	644,000
FCCT-EG-30100-24-012	FCCT-HDG-30100-24-012	300	100	2400	1.2	490,000	713,000
FCCT-EG-40100-24-012	FCCT-HDG-40100-24-012	400	100	2400	1.2	585,000	851,000

COVER TRAY - U & C

Type		Size (mm)			Price (Rp)	
Electro Galvanize	Hotdip Galvanize	Width	Length	Thickness	Electro GV	Hotdip GV
FCT-EG-50-24-012	FCT-HDG-50-24-012	50	2400	1.2	78,000	118,000
FCT-EG-100-24-012	FCT-HDG-100-24-012	100	2400	1.2	129,000	196,000
FCT-EG-150-24-012	FCT-HDG-150-24-012	150	2400	1.2	179,000	276,000
FCT-EG-200-24-012	FCT-HDG-200-24-012	200	2400	1.2	232,000	353,000
FCT-EG-250-24-012	FCT-HDG-250-24-012	250	2400	1.2	282,000	431,000
FCT-EG-300-24-012	FCT-HDG-300-24-012	300	2400	1.2	333,000	512,000
FCT-EG-400-24-012	FCT-HDG-400-24-012	400	2400	1.2	436,000	669,000

Horizontal Elbow - TRAY

Specification :

* Material : Hot Rolled Miled Steel Sheet (SPHC)

* Thickness : 1.2mm

* Radius : 300mm

* Bend Angel : 90 degree

* Plating : Electro Galvanize / Hotdip Galvanize

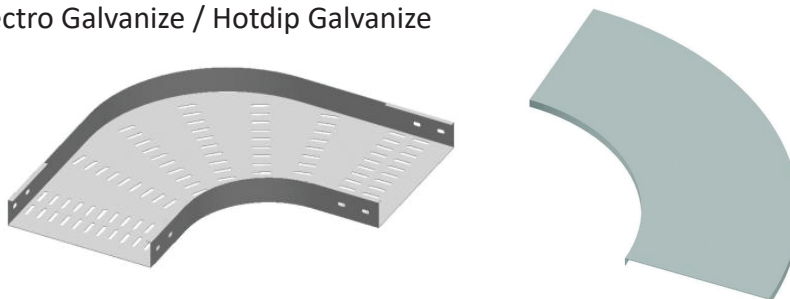

Type		Size (mm)			Price (Rp)	
Electro Galvanize	Hotdip Galvanize	Width	Height	Thickness	Electro GV	Hotdip GV
FLCT-EG-0550-012	FLCT-HDG-0550-012	50	50	1.2	92,000	123,000
FLCT-EG-1050-012	FLCT-HDG-1050-012	100	50	1.2	114,000	156,000
FLCT-EG-1550-012	FLCT-HDG-1550-012	150	50	1.2	140,000	194,000
FLCT-EG-2050-012	FLCT-HDG-2050-012	200	50	1.2	167,000	236,000
FLCT-EG-2550-012	FLCT-HDG-2550-012	250	50	1.2	196,000	282,000
FLCT-EG-3050-012	FLCT-HDG-3050-012	300	50	1.2	230,000	333,000
FLCT-EG-4050-012	FLCT-HDG-4050-012	400	50	1.2	303,000	446,000

Type		Size (mm)			Price (Rp)	
Electro Galvanize	Hotdip Galvanize	Width	Height	Thickness	Electro GV	Hotdip GV
FLCT-EG-10100-012	FLCT-HDG-10100-012	100	100	1.2	148,000	207,000
FLCT-EG-15100-012	FLCT-HDG-15100-012	150	100	1.2	173,000	249,000
FLCT-EG-20100-012	FLCT-HDG-20100-012	200	100	1.2	202,000	293,000
FLCT-EG-25100-012	FLCT-HDG-25100-012	250	100	1.2	236,000	344,000
FLCT-EG-30100-012	FLCT-HDG-30100-012	300	100	1.2	269,000	395,000
FLCT-EG-40100-012	FLCT-HDG-40100-012	400	100	1.2	347,000	515,000

Cover Horizontal Elbow - TRAY

Type		Size (mm)		Price (Rp)	
Electro Galvanize	Hotdip Galvanize	Width	Thickness	Electro GV	Hotdip GV
FHLC-EG-50-012	FHLC-HDG-50-012	50	1.2	64,000	78,000
FHLC-EG-100-012	FHLC-HDG-100-012	100	1.2	83,000	110,000
FHLC-EG-150-012	FHLC-HDG-150-012	150	1.2	106,000	143,000
FHLC-EG-200-012	FHLC-HDG-200-012	200	1.2	131,000	184,000
FHLC-EG-250-012	FHLC-HDG-250-012	250	1.2	160,000	227,000
FHLC-EG-300-012	FHLC-HDG-300-012	300	1.2	192,000	274,000
FHLC-EG-400-012	FHLC-HDG-400-012	400	1.2	261,000	381,000

Horizontal Diagonal - TRAY

Specification :

- * Material : Hot Rolled Miled Steel Sheet (SPHC)
- * Thickness : 1.2mm
- * Radius : 300mm
- * Bend Angel : 90 degree
- * Plating : Electro Galvanize / Hotdip Galvanize

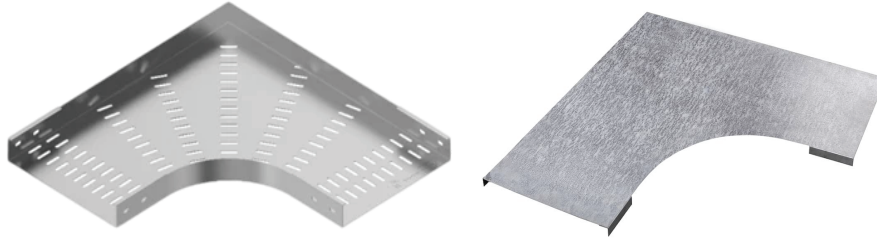

Type		Size (mm)			Price (Rp)	
Electro Galvanize	Hotdip Galvanize	Width	Height	Thickness	Electro GV	Hotdip GV
FDCT-EG-0550-012	FDCT-HDG-0550-012	50	50	1.2	92,000	123,000
FDCT-EG-1050-012	FDCT-HDG-1050-012	100	50	1.2	114,000	156,000
FDCT-EG-1550-012	FDCT-HDG-1550-012	150	50	1.2	140,000	194,000
FDCT-EG-2050-012	FDCT-HDG-2050-012	200	50	1.2	167,000	236,000
FDCT-EG-2550-012	FDCT-HDG-2550-012	250	50	1.2	196,000	282,000
FDCT-EG-3050-012	FDCT-HDG-3050-012	300	50	1.2	230,000	333,000
FDCT-EG-4050-012	FDCT-HDG-4050-012	400	50	1.2	303,000	446,000

Type		Size (mm)			Price (Rp)	
Electro Galvanize	Hotdip Galvanize	Width	Height	Thickness	Electro GV	Hotdip GV
FDCT-EG-10100-012	FDCT-HDG-10100-012	100	100	1.2	148,000	207,000
FDCT-EG-15100-012	FDCT-HDG-15100-012	150	100	1.2	173,000	249,000
FDCT-EG-20100-012	FDCT-HDG-20100-012	200	100	1.2	202,000	293,000
FDCT-EG-25100-012	FDCT-HDG-25100-012	250	100	1.2	236,000	344,000
FDCT-EG-30100-012	FDCT-HDG-30100-012	300	100	1.2	269,000	395,000
FDCT-EG-40100-012	FDCT-HDG-40100-012	400	100	1.2	347,000	515,000

Cover Horizontal Diagonal - TRAY

Type		Size (mm)		Price (Rp)	
Electro Galvanize	Hotdip Galvanize	Width	Thickness	Electro GV	Hotdip GV
FHLC-EG-50-012	FHLC-HDG-50-012	50	1.2	64,000	78,000
FHLC-EG-100-012	FHLC-HDG-100-012	100	1.2	83,000	110,000
FHLC-EG-150-012	FHLC-HDG-150-012	150	1.2	106,000	143,000
FHLC-EG-200-012	FHLC-HDG-200-012	200	1.2	131,000	184,000
FHLC-EG-250-012	FHLC-HDG-250-012	250	1.2	160,000	227,000
FHLC-EG-300-012	FHLC-HDG-300-012	300	1.2	192,000	274,000
FHLC-EG-400-012	FHLC-HDG-400-012	400	1.2	261,000	381,000

Horizontal Tee - TRAY

Specification :

- * Material : Hot Rolled Miled Steel Sheet (SPHC)
- * Thickness : 1.2mm
- * Radius : 300mm
- * Bend Angel : 90 degree
- * Plating : Electro Galvanize / Hotdip Galvanize

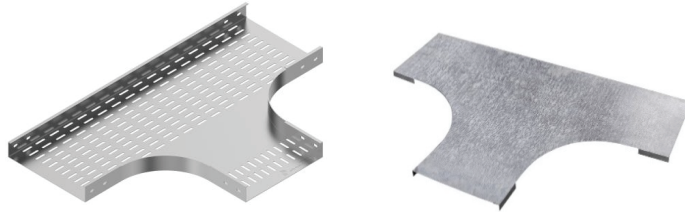

Type		Size (mm)			Price (Rp)	
Electro Galvanize	Hotdip Galvanize	Width	Height	Thickness	Electro GV	Hotdip GV
FTCT-EG-0550-012	FTCT-HDG-0550-012	50	50	1.2	156,000	202,000
FTCT-EG-1050-012	FTCT-HDG-1050-012	100	50	1.2	185,000	246,000
FTCT-EG-1550-012	FTCT-HDG-1550-012	150	50	1.2	218,000	297,000
FTCT-EG-2050-012	FTCT-HDG-2050-012	200	50	1.2	251,000	350,000
FTCT-EG-2550-012	FTCT-HDG-2550-012	250	50	1.2	288,000	406,000
FTCT-EG-3050-012	FTCT-HDG-3050-012	300	50	1.2	328,000	467,000
FTCT-EG-4050-012	FTCT-HDG-4050-012	400	50	1.2	417,000	602,000

Type		Size (mm)			Price (Rp)	
Electro Galvanize	Hotdip Galvanize	Width	Height	Thickness	Electro GV	Hotdip GV
FTCT-EG-10100-012	FTCT-HDG-10100-012	100	100	1.2	232,000	318,000
FTCT-EG-15100-012	FTCT-HDG-15100-012	150	100	1.2	266,000	370,000
FTCT-EG-20100-012	FTCT-HDG-20100-012	200	100	1.2	302,000	425,000
FTCT-EG-25100-012	FTCT-HDG-25100-012	250	100	1.2	339,000	484,000
FTCT-EG-30100-012	FTCT-HDG-30100-012	300	100	1.2	381,000	546,000
FTCT-EG-40100-012	FTCT-HDG-40100-012	400	100	1.2	471,000	686,000

Cover Horizontal TEE - TRAY

Type		Size (mm)		Price (Rp)	
Electro Galvanize	Hotdip Galvanize	Width	Thickness	Electro GV	Hotdip GV
FCTE-EG-50-012	FCTE-HDG-50-012	50	1.2	112,000	135,000
FCTE-EG-100-012	FCTE-HDG-100-012	100	1.2	142,000	179,000
FCTE-EG-150-012	FCTE-HDG-150-012	150	1.2	171,000	226,000
FCTE-EG-200-012	FCTE-HDG-200-012	200	1.2	204,000	276,000
FCTE-EG-250-012	FCTE-HDG-250-012	250	1.2	240,000	333,000
FCTE-EG-300-012	FCTE-HDG-300-012	300	1.2	278,000	392,000
FCTE-EG-400-012	FCTE-HDG-400-012	400	1.2	364,000	521,000

Horizontal Cross - TRAY

Specification :

- * Material : Hot Rolled Miled Steel Sheet (SPHC)
- * Thickness : 1.2mm
- * Radius : 300mm
- * Bend Angel : 90 degree
- * Plating : Electro Galvanize / Hotdip Galvanize

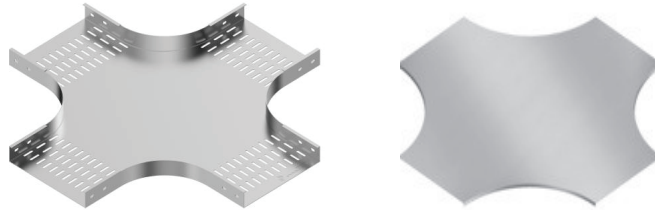

Type		Size (mm)			Price (Rp)	
Electro Galvanize	Hotdip Galvanize	Width	Height	Thickness	Electro GV	Hotdip GV
FCCT-EG-0550-012	FCCT-HDG-0550-012	50	50	1.2	252,000	316,000
FCCT-EG-1050-012	FCCT-HDG-1050-012	100	50	1.2	288,000	370,000
FCCT-EG-1550-012	FCCT-HDG-1550-012	150	50	1.2	328,000	429,000
FCCT-EG-2050-012	FCCT-HDG-2050-012	200	50	1.2	369,000	492,000
FCCT-EG-2550-012	FCCT-HDG-2550-012	250	50	1.2	412,000	560,000
FCCT-EG-3050-012	FCCT-HDG-3050-012	300	50	1.2	459,000	630,000
FCCT-EG-4050-012	FCCT-HDG-4050-012	400	50	1.2	560,000	784,000

Type		Size (mm)			Price (Rp)	
Electro Galvanize	Hotdip Galvanize	Width	Height	Thickness	Electro GV	Hotdip GV
FCCT-EG-10100-012	FCCT-HDG-10100-012	100	100	1.2	345,000	459,000
FCCT-EG-15100-012	FCCT-HDG-15100-012	150	100	1.2	386,000	518,000
FCCT-EG-20100-012	FCCT-HDG-20100-012	200	100	1.2	425,000	579,000
FCCT-EG-25100-012	FCCT-HDG-25100-012	250	100	1.2	470,000	646,000
FCCT-EG-30100-012	FCCT-HDG-30100-012	300	100	1.2	515,000	717,000
FCCT-EG-40100-012	FCCT-HDG-40100-012	400	100	1.2	616,000	873,000

Cover Horizontal CROSS - TRAY

Type		Size (mm)		Price (Rp)	
Electro Galvanize	Hotdip Galvanize	Width	Thickness	Electro GV	Hotdip GV
FCZC-EG-50-012	FCZC-HDG-50-012	50	1.2	201,000	232,000
FCZC-EG-100-012	FCZC-HDG-100-012	100	1.2	234,000	286,000
FCZC-EG-150-012	FCZC-HDG-150-012	150	1.2	274,000	345,000
FCZC-EG-200-012	FCZC-HDG-200-012	200	1.2	314,000	408,000
FCZC-EG-250-012	FCZC-HDG-250-012	250	1.2	358,000	476,000
FCZC-EG-300-012	FCZC-HDG-300-012	300	1.2	404,000	546,000
FCZC-EG-400-012	FCZC-HDG-400-012	400	1.2	504,000	700,000

Vertical Inside Riser - TRAY

Specification :

- * Material : Hot Rolled Miled Steel Sheet (SPHC)
- * Thickness : 1.2mm
- * Radius : 300mm
- * Bend Angel : 90 degree
- * Plating : Electro Galvanize / Hotdip Galvanize

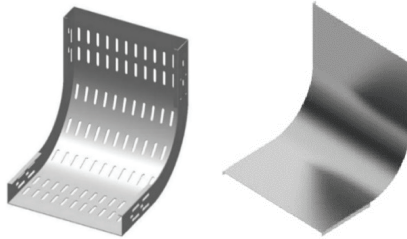

Type		Size (mm)			Price (Rp)	
Electro Galvanize	Hotdip Galvanize	Width	Height	Thickness	Electro GV	Hotdip GV
FIRT-EG-0550-012	FIRT-HDG-0550-012	50	50	1.2	75,000	106,000
FIRT-EG-1050-012	FIRT-HDG-1050-012	100	50	1.2	92,000	131,000
FIRT-EG-1550-012	FIRT-HDG-1550-012	150	50	1.2	106,000	156,000
FIRT-EG-2050-012	FIRT-HDG-2050-012	200	50	1.2	123,000	182,000
FIRT-EG-2550-012	FIRT-HDG-2550-012	250	50	1.2	140,000	207,000
FIRT-EG-3050-012	FIRT-HDG-3050-012	300	50	1.2	156,000	232,000
FIRT-EG-4050-012	FIRT-HDG-4050-012	400	50	1.2	188,000	282,000

Type		Size (mm)			Price (Rp)	
Electro Galvanize	Hotdip Galvanize	Width	Height	Thickness	Electro GV	Hotdip GV
FIRT-EG-10100-012	FIRT-HDG-10100-012	100	100	1.2	156,000	221,000
FIRT-EG-15100-012	FIRT-HDG-15100-012	150	100	1.2	176,000	251,000
FIRT-EG-20100-012	FIRT-HDG-20100-012	200	100	1.2	194,000	278,000
FIRT-EG-25100-012	FIRT-HDG-25100-012	250	100	1.2	210,000	308,000
FIRT-EG-30100-012	FIRT-HDG-30100-012	300	100	1.2	230,000	335,000
FIRT-EG-40100-012	FIRT-HDG-40100-012	400	100	1.2	268,000	392,000

Cover Inside Riser - TRAY

Type		Size (mm)		Price (Rp)	
Electro Galvanize	Hotdip Galvanize	Width	Thickness	Electro GV	Hotdip GV
FIRC-EG-50-012	FIRC-HDG-50-012	50	1.2	22,000	34,000
FIRC-EG-100-012	FIRC-HDG-100-012	100	1.2	36,000	56,000
FIRC-EG-150-012	FIRC-HDG-150-012	150	1.2	51,000	76,000
FIRC-EG-200-012	FIRC-HDG-200-012	200	1.2	66,000	100,000
FIRC-EG-250-012	FIRC-HDG-250-012	250	1.2	78,000	120,000
FIRC-EG-300-012	FIRC-HDG-300-012	300	1.2	93,000	142,000
FIRC-EG-400-012	FIRC-HDG-400-012	400	1.2	120,000	185,000

Vertical Outside Riser - TRAY

Specification :

- * Material : Hot Rolled Miled Steel Sheet (SPHC)
- * Thickness : 1.2mm
- * Radius : 300mm
- * Bend Angel : 90 degree
- * Plating : Electro Galvanize / Hotdip Galvanize

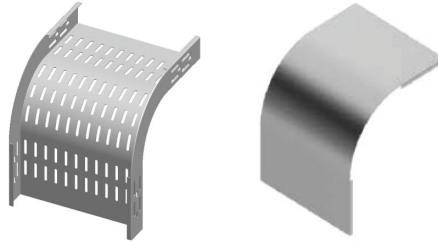

Type		Size (mm)			Price (Rp)	
Electro Galvanize	Hotdip Galvanize	Width	Height	Thickness	Electro GV	Hotdip GV
FORT-EG-0550-012	FORT-HDG-0550-012	50	50	1.2	68,000	100,000
FORT-EG-1050-012	FORT-HDG-1050-012	100	50	1.2	83,000	120,000
FORT-EG-1550-012	FORT-HDG-1550-012	150	50	1.2	95,000	143,000
FORT-EG-2050-012	FORT-HDG-2050-012	200	50	1.2	110,000	165,000
FORT-EG-2550-012	FORT-HDG-2550-012	250	50	1.2	125,000	185,000
FORT-EG-3050-012	FORT-HDG-3050-012	300	50	1.2	140,000	209,000
FORT-EG-4050-012	FORT-HDG-4050-012	400	50	1.2	167,000	251,000

Type		Size (mm)			Price (Rp)	
Electro Galvanize	Hotdip Galvanize	Width	Height	Thickness	Electro GV	Hotdip GV
FORT-EG-10100-012	FORT-HDG-10100-012	100	100	1.2	135,000	196,000
FORT-EG-15100-012	FORT-HDG-15100-012	150	100	1.2	148,000	218,000
FORT-EG-20100-012	FORT-HDG-20100-012	200	100	1.2	162,000	240,000
FORT-EG-25100-012	FORT-HDG-25100-012	250	100	1.2	177,000	261,000
FORT-EG-30100-012	FORT-HDG-30100-012	300	100	1.2	190,000	282,000
FORT-EG-40100-012	FORT-HDG-40100-012	400	100	1.2	219,000	327,000

Cover Outside Riser - TRAY

Type		Size (mm)		Price (Rp)	
Electro Galvanize	Hotdip Galvanize	Width	Thickness	Electro GV	Hotdip GV
FORC-EG-50-012	FORC-HDG-50-012	50	1.2	30,000	47,000
FORC-EG-100-012	FORC-HDG-100-012	100	1.2	51,000	76,000
FORC-EG-150-012	FORC-HDG-150-012	150	1.2	70,000	106,000
FORC-EG-200-012	FORC-HDG-200-012	200	1.2	89,000	135,000
FORC-EG-250-012	FORC-HDG-250-012	250	1.2	108,000	167,000
FORC-EG-300-012	FORC-HDG-300-012	300	1.2	129,000	196,000
FORC-EG-400-012	FORC-HDG-400-012	400	1.2	167,000	255,000

Reducer - TRAY

Specification :

- * Material : Hot Rolled Miled Steel Sheet (SPHC)
- * Thickness : 1.2mm
- * Length : 600mm
- * Plating : Electro Galvanize / Hotdip Galvanize



LEFT REDUCER



RIGHT REDUCER

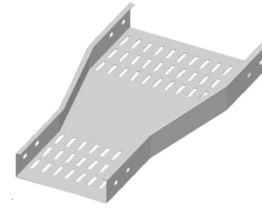

STRAIGHT REDUCER

Type		Size (mm)			Price (Rp)	
Electro Galvanize	Hotdip Galvanize	Width	Height	Thickness	Electro GV	Hotdip GV
FRCT-EG-1050-012	FRCT-HDG-1050-012	100	50	1.2	106,000	162,000
FRCT-EG-1550-012	FRCT-HDG-1550-012	150	50	1.2	123,000	188,000
FRCT-EG-2050-012	FRCT-HDG-2050-012	200	50	1.2	140,000	210,000
FRCT-EG-2550-012	FRCT-HDG-2550-012	250	50	1.2	154,000	236,000
FRCT-EG-3050-012	FRCT-HDG-3050-012	300	50	1.2	171,000	261,000
FRCT-EG-4050-012	FRCT-HDG-4050-012	400	50	1.2	202,000	310,000

Type		Size (mm)			Price (Rp)	
Electro Galvanize	Hotdip Galvanize	Width	Height	Thickness	Electro GV	Hotdip GV
FRCT-EG-15100-012	FRCT-HDG-15100-012	150	100	1.2	185,000	285,000
FRCT-EG-20100-012	FRCT-HDG-20100-012	200	100	1.2	202,000	310,000
FRCT-EG-25100-012	FRCT-HDG-25100-012	250	100	1.2	218,000	335,000
FRCT-EG-30100-012	FRCT-HDG-30100-012	300	100	1.2	234,000	358,000
FRCT-EG-40100-012	FRCT-HDG-40100-012	400	100	1.2	266,000	406,000

Cover Reducer - TRAY

Type		Size (mm)		Price (Rp)	
Electro Galvanize	Hotdip Galvanize	Width	Thickness	Electro GV	Hotdip GV
FCRT-EG-100-012	FCRT-HDG-100-012	100	1.2	41,000	62,000
FCRT-EG-150-012	FCRT-HDG-150-012	150	1.2	58,000	87,000
FCRT-EG-200-012	FCRT-HDG-200-012	200	1.2	72,000	110,000
FCRT-EG-250-012	FCRT-HDG-250-012	250	1.2	89,000	135,000
FCRT-EG-300-012	FCRT-HDG-300-012	300	1.2	104,000	160,000
FCRT-EG-400-012	FCRT-HDG-400-012	400	1.2	137,000	209,000

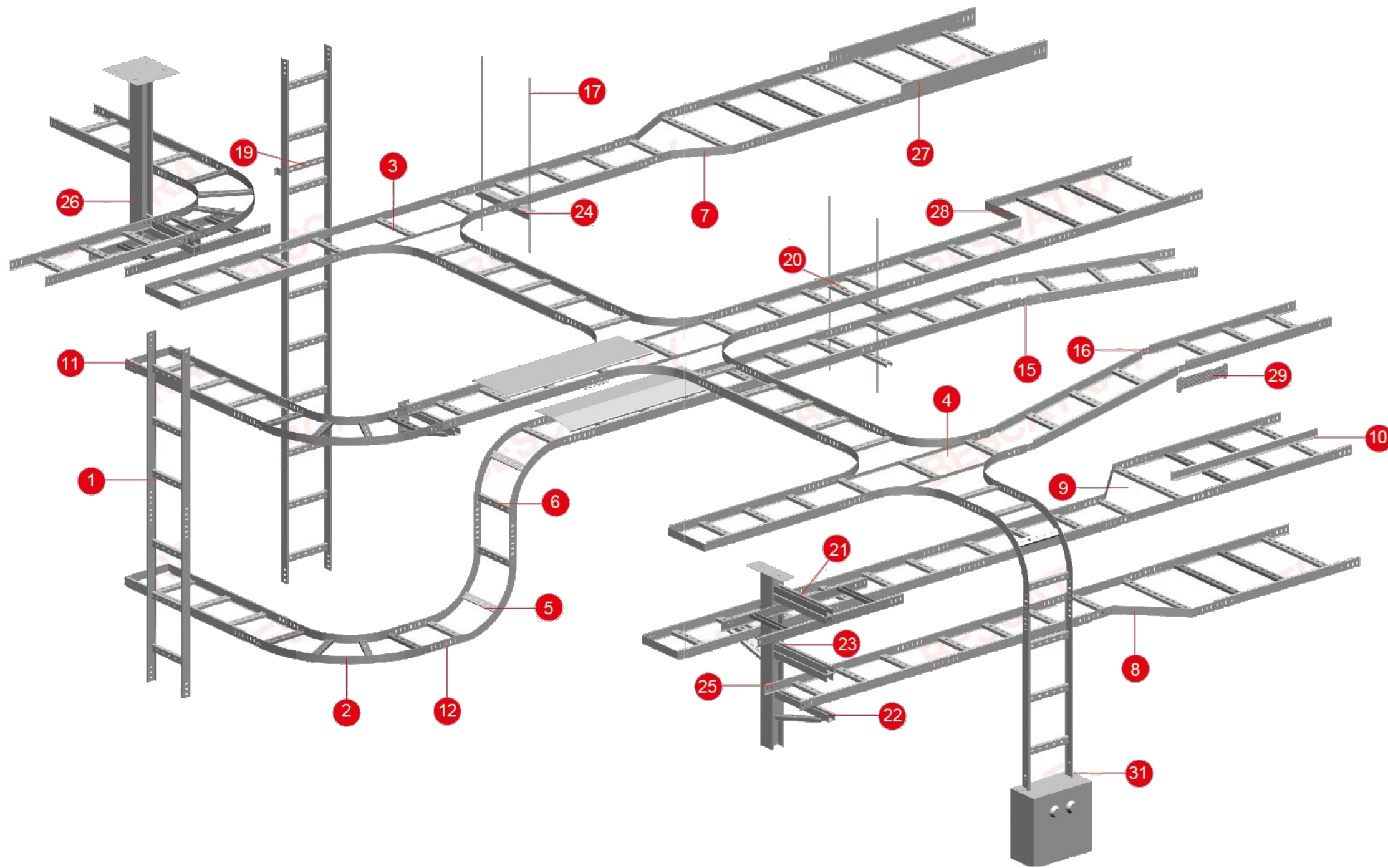

- | | | | | | |
|---|--|---|--|---|--|
| <ul style="list-style-type: none"> 1 Cable Ladder (BL*) 2 Elbow 90° (BL*-E) 3 Tee (BL*-T) 4 Cross (BL*-C) 5 Inside Riser (BL*-IR) 6 Outside Riser (BL*-OR) 7 Reducer (BL*-R) | <ul style="list-style-type: none"> 8 Right Hand Reducer (BL*-RR) 9 Left Hand Reducer (BL*-LR) 10 Divider (BL*-D) 11 Blind End (BL*-BE) 12 Straight Coupler (BL*-SC) 13 Cover Clamp (BL*-CLP) 14 Hold Down Bracket (BL*-HDB) | <ul style="list-style-type: none"> 15 Horizontal Adjust Coupler (BL*-HAC) 16 Vertical Adjust Coupler (BL*-VAC) 17 Treaded Rod (TR) 18 Bolt & Nut (BN) 19 Under Floor Stand (UFS) 20 Straight Bracket (SB) 21 Wall Bracket (WB) | <ul style="list-style-type: none"> 22 Strengthen Bracket (STB) 23 Strengthening Bracket (STNB) 24 Angle Bar Bracket (ABB) 25 Ceiling Bracket (CB) 26 Strengthening Ceiling Bracket (SCB) 27 Height Adjust Coupler (HAC) 28 Width Adjust Coupler (WAC) | <ul style="list-style-type: none"> 29 Bonding Jumper (BJ) 30 Hold Down Clamp (HDC) 31 Corner Plate (CP) 32 Flat Cover (FSC) 33 Peak Cover (PSC) 34 Elbow 90° Cover (BL-ENC) 35 Tee Cover (BL-TC) | <ul style="list-style-type: none"> 36 Cross Cover (BL-CC) 37 Inside Riser Cover (BL-IRC) 38 Outside Riser Cover (BL-ORC) 39 Reducer Cover (BL-RC) 40 Right Hand Reducer Cover (BL-RRC) 41 Left Hand Reducer Cover (BL-LRC) |
|---|--|---|--|---|--|

U - Ladder

Specification :

- * Material : Hot Rolled Miled Steel Sheet (SPHC)
- * Thickness : 1.2mm
- * Plating : Electro Galvanize / Hotdip Galvanize

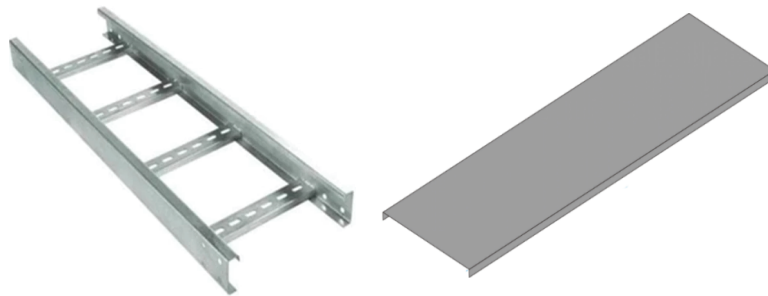

Type		Size (mm)				Price (Rp)	
Electro Galvanize	Hotdip Galvanize	Width	Height	Length	Thickness	Electro GV	Hotdip GV
FUL-EG-10100-24-012	FUL-HDG-10100-24-012	100	100	2400	1.2	285,000	436,000
FUL-EG-15100-24-012	FUL-HDG-15100-24-012	150	100	2400	1.2	302,000	461,000
FUL-EG-20100-24-012	FUL-HDG-20100-24-012	200	100	2400	1.2	318,000	488,000
FUL-EG-30100-24-012	FUL-HDG-30100-24-012	300	100	2400	1.2	352,000	540,000
FUL-EG-40100-24-012	FUL-HDG-40100-24-012	400	100	2400	1.2	387,000	593,000
FUL-EG-50100-24-012	FUL-HDG-50100-24-012	500	100	2400	1.2	420,000	646,000
FUL-EG-60100-24-012	FUL-HDG-60100-24-012	600	100	2400	1.2	454,000	698,000

Cover U - Ladder

Type		Size (mm)		Price (Rp)	
Electro Galvanize	Hotdip Galvanize	Width	Thickness	Electro GV	Hotdip GV
FCLU-EG-100-012	FCLU-HDG-100-012	100	1.2	129,000	196,000
FCLU-EG-150-012	FCLU-HDG-150-012	150	1.2	179,000	276,000
FCLU-EG-200-012	FCLU-HDG-200-012	200	1.2	232,000	353,000
FCLU-EG-300-012	FCLU-HDG-300-012	300	1.2	333,000	512,000
FCLU-EG-400-012	FCLU-HDG-400-012	400	1.2	436,000	669,000
FCLU-EG-500-012	FCLU-HDG-500-012	500	1.2	538,000	788,000
FCLU-EG-600-012	FCLU-HDG-600-012	600	1.2	639,000	982,000

W - Ladder

Specification :

* Material : Hot Rolled Miled Steel Sheet (SPHC)

* Thickness : 1.2mm

* Plating : Electro Galvanize / Hotdip Galvanize

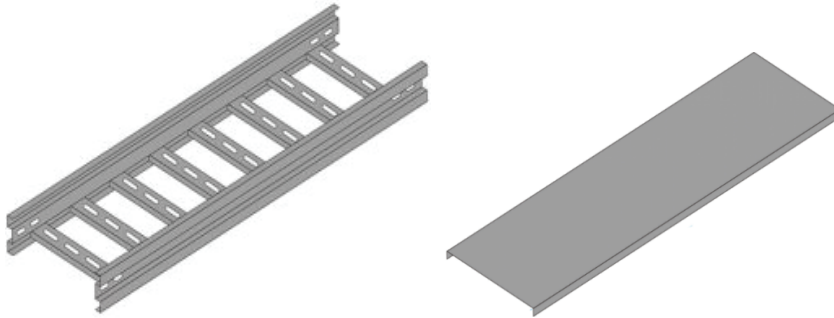

Type		Size (mm)				Price (Rp)	
Electro Galvanize	Hotdip Galvanize	Width	Height	Length	Thickness	Electro GV	Hotdip GV
FWL-EG-10100-24-012	FWL-HDG-10100-24-012	100	100	2400	1.2	339,000	520,000
FWL-EG-15100-24-012	FWL-HDG-15100-24-012	150	100	2400	1.2	353,000	540,000
FWL-EG-20100-24-012	FWL-HDG-20100-24-012	200	100	2400	1.2	366,000	562,000
FWL-EG-30100-24-012	FWL-HDG-30100-24-012	300	100	2400	1.2	394,000	604,000
FWL-EG-40100-24-012	FWL-HDG-40100-24-012	400	100	2400	1.2	420,000	646,000
FWL-EG-50100-24-012	FWL-HDG-50100-24-012	500	100	2400	1.2	448,000	688,000
FWL-EG-60100-24-012	FWL-HDG-60100-24-012	600	100	2400	1.2	476,000	730,000

Type		Size (mm)		Price (Rp)	
Electro Galvanize	Hotdip Galvanize	Width	Thickness	Electro GV	Hotdip GV
FCLW-EG-100-012	FCLW-HDG-100-012	100	1.2	129,000	196,000
FCLW-EG-150-012	FCLW-HDG-150-012	150	1.2	179,000	276,000
FCLW-EG-200-012	FCLW-HDG-200-012	200	1.2	232,000	353,000
FCLW-EG-300-012	FCLW-HDG-300-012	300	1.2	333,000	512,000
FCLW-EG-400-012	FCLW-HDG-400-012	400	1.2	436,000	669,000
FCLW-EG-500-012	FCLW-HDG-500-012	500	1.2	538,000	824,000
FCLW-EG-600-012	FCLW-HDG-600-012	600	1.2	639,000	982,000

Horizontal Elbow U - Ladder

Specification :

- * Material : Hot Rolled Miled Steel Sheet (SPHC)
- * Thickness : 1.2mm
- * Radius : 300mm
- * Bend Angel : 90 degree
- * Plating : Electro Galvanize / Hotdip Galvanize

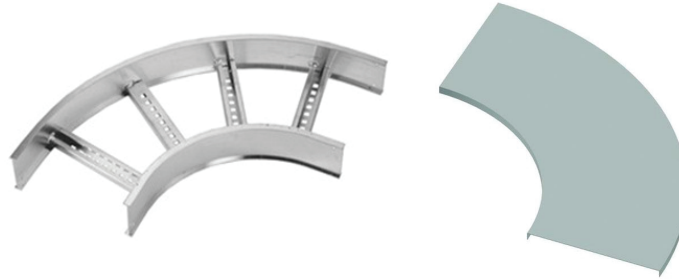

Elbow U - Ladder

Type		Size (mm)			Price (Rp)	
Electro Galvanize	Hotdip Galvanize	Width	Height	Thickness	Electro GV	Hotdip GV
FLUL-EG-10100-012	FLUL-HDG-10100-012	100	100	1.2	131,000	198,000
FLUL-EG-15100-012	FLUL-HDG-15100-012	150	100	1.2	146,000	224,000
FLUL-EG-20100-012	FLUL-HDG-20100-012	200	100	1.2	160,000	244,000
FLUL-EG-30100-012	FLUL-HDG-30100-012	300	100	1.2	190,000	291,000
FLUL-EG-40100-012	FLUL-HDG-40100-012	400	100	1.2	238,000	364,000
FLUL-EG-50100-012	FLUL-HDG-50100-012	500	100	1.2	274,000	419,000
FLUL-EG-60100-012	FLUL-HDG-60100-012	600	100	1.2	350,000	537,000

Cover Elbow U & W - Ladder

Type		Size (mm)		Price (Rp)	
Electro Galvanize	Hotdip Galvanize	Width	Thickness	Electro GV	Hotdip GV
FCEL-EG-100-012	FCEL-HDG-100-012	100	1.2	83,000	110,000
FCEL-EG-150-012	FCEL-HDG-150-012	150	1.2	106,000	143,000
FCEL-EG-200-012	FCEL-HDG-200-012	200	1.2	131,000	184,000
FCEL-EG-300-012	FCEL-HDG-300-012	300	1.2	192,000	274,000
FCEL-EG-400-012	FCEL-HDG-400-012	400	1.2	261,000	381,000
FCEL-EG-500-012	FCEL-HDG-500-012	500	1.2	341,000	504,000
FCEL-EG-600-012	FCEL-HDG-600-012	600	1.2	431,000	644,000

Horizontal Elbow W - Ladder

Specification :

- * Material : Hot Rolled Miled Steel Sheet (SPHC)
- * Thickness : 1.2mm
- * Radius : 300mm
- * Bend Angel : 90 degree
- * Plating : Electro Galvanize / Hotdip Galvanize

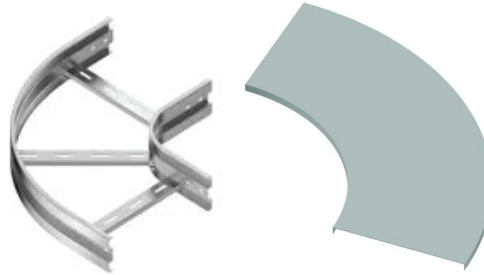

Elbow W - Ladder

Type		Size (mm)			Price (Rp)	
Electro Galvanize	Hotdip Galvanize	Width	Height	Thickness	Electro GV	Hotdip GV
FLWL-EG-10100-012	FLWL-HDG-10100-012	100	100	1.2	138,000	208,000
FLWL-EG-15100-012	FLWL-HDG-15100-012	150	100	1.2	153,000	235,000
FLWL-EG-20100-012	FLWL-HDG-20100-012	200	100	1.2	168,000	256,000
FLWL-EG-30100-012	FLWL-HDG-30100-012	300	100	1.2	200,000	306,000
FLWL-EG-40100-012	FLWL-HDG-40100-012	400	100	1.2	250,000	382,000
FLWL-EG-50100-012	FLWL-HDG-50100-012	500	100	1.2	288,000	440,000
FLWL-EG-60100-012	FLWL-HDG-60100-012	600	100	1.2	368,000	564,000

Cover Elbow U & W - Ladder

Type		Size (mm)		Price (Rp)	
Electro Galvanize	Hotdip Galvanize	Width	Thickness	Electro GV	Hotdip GV
FCEL-EG-100-012	FCEL-HDG-100-012	100	1.2	83,000	110,000
FCEL-EG-150-012	FCEL-HDG-150-012	150	1.2	106,000	143,000
FCEL-EG-200-012	FCEL-HDG-200-012	200	1.2	131,000	184,000
FCEL-EG-300-012	FCEL-HDG-300-012	300	1.2	192,000	274,000
FCEL-EG-400-012	FCEL-HDG-400-012	400	1.2	261,000	381,000
FCEL-EG-500-012	FCEL-HDG-500-012	500	1.2	341,000	504,000
FCEL-EG-600-012	FCEL-HDG-600-012	600	1.2	431,000	644,000

Horizontal Diagonal U - Ladder

Specification :

- * Material : Hot Rolled Miled Steel Sheet (SPHC)
- * Thickness : 1.2mm
- * Radius : 300mm
- * Bend Angel : 90 degree
- * Plating : Electro Galvanize / Hotdip Galvanize

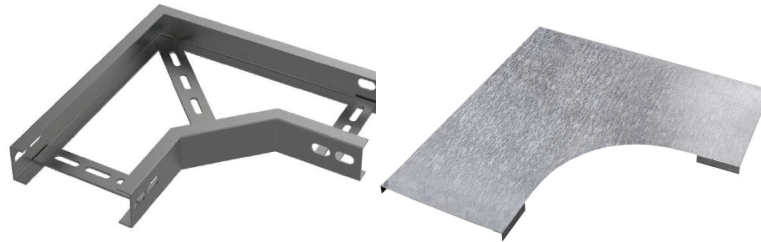

Diagonal U - Ladder

Type		Size (mm)			Price (Rp)	
Electro Galvanize	Hotdip Galvanize	Width	Height	Thickness	Electro GV	Hotdip GV
FDUL-EG-10100-012	FDUL-HDG-10100-012	100	100	1.2	131,000	198,000
FDUL-EG-15100-012	FDUL-HDG-15100-012	150	100	1.2	146,000	224,000
FDUL-EG-20100-012	FDUL-HDG-20100-012	200	100	1.2	160,000	244,000
FDUL-EG-30100-012	FDUL-HDG-30100-012	300	100	1.2	190,000	291,000
FDUL-EG-40100-012	FDUL-HDG-40100-012	400	100	1.2	238,000	364,000
FDUL-EG-50100-012	FDUL-HDG-50100-012	500	100	1.2	274,000	419,000
FDUL-EG-60100-012	FDUL-HDG-60100-012	600	100	1.2	350,000	537,000

Cover Diagonal U & W - Ladder

Type		Size (mm)		Price (Rp)	
Electro Galvanize	Hotdip Galvanize	Width	Thickness	Electro GV	Hotdip GV
FCDL-EG-100-012	FCDL-HDG-100-012	100	1.2	83,000	110,000
FCDL-EG-150-012	FCDL-HDG-150-012	150	1.2	106,000	143,000
FCDL-EG-200-012	FCDL-HDG-200-012	200	1.2	131,000	184,000
FCDL-EG-300-012	FCDL-HDG-300-012	300	1.2	192,000	274,000
FCDL-EG-400-012	FCDL-HDG-400-012	400	1.2	261,000	381,000
FCDL-EG-500-012	FCDL-HDG-500-012	500	1.2	341,000	504,000
FCDL-EG-600-012	FCDL-HDG-600-012	600	1.2	431,000	644,000

Horizontal Diagonal W - Ladder

Specification :

- * Material : Hot Rolled Miled Steel Sheet (SPHC)
- * Thickness : 1.2mm
- * Radius : 300mm
- * Bend Angel : 90 degree
- * Plating : Electro Galvanize / Hotdip Galvanize

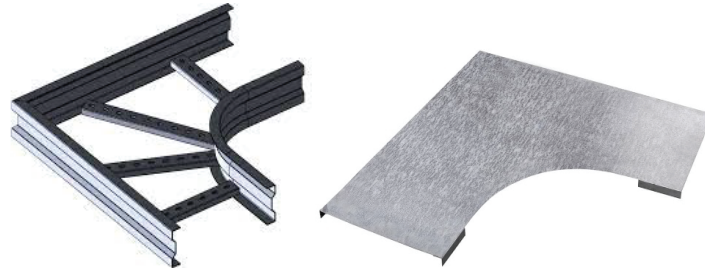

Diagonal W - Ladder

Type		Size (mm)			Price (Rp)	
Electro Galvanize	Hotdip Galvanize	Width	Height	Thickness	Electro GV	Hotdip GV
FDWL-EG-10100-012	FDWL-HDG-10100-012	100	100	1.2	138,000	208,000
FDWL-EG-15100-012	FDWL-HDG-15100-012	150	100	1.2	153,000	235,000
FDWL-EG-20100-012	FDWL-HDG-20100-012	200	100	1.2	168,000	256,000
FDWL-EG-30100-012	FDWL-HDG-30100-012	300	100	1.2	200,000	306,000
FDWL-EG-40100-012	FDWL-HDG-40100-012	400	100	1.2	250,000	382,000
FDWL-EG-50100-012	FDWL-HDG-50100-012	500	100	1.2	288,000	440,000
FDWL-EG-60100-012	FDWL-HDG-60100-012	600	100	1.2	368,000	564,000

Cover Diagonal U & W - Ladder

Type		Size (mm)		Price (Rp)	
Electro Galvanize	Hotdip Galvanize	Width	Thickness	Electro GV	Hotdip GV
FCDL-EG-100-012	FCDL-HDG-100-012	100	1.2	83,000	110,000
FCDL-EG-150-012	FCDL-HDG-150-012	150	1.2	106,000	143,000
FCDL-EG-200-012	FCDL-HDG-200-012	200	1.2	131,000	184,000
FCDL-EG-300-012	FCDL-HDG-300-012	300	1.2	192,000	274,000
FCDL-EG-400-012	FCDL-HDG-400-012	400	1.2	261,000	381,000
FCDL-EG-500-012	FCDL-HDG-500-012	500	1.2	341,000	504,000
FCDL-EG-600-012	FCDL-HDG-600-012	600	1.2	431,000	644,000

Horizontal Tee U - Ladder

Specification :

- * Material : Hot Rolled Miled Steel Sheet (SPHC)
- * Thickness : 1.2mm
- * Radius : 300mm
- * Bend Angel : 90 degree
- * Plating : Electro Galvanize / Hotdip Galvanize

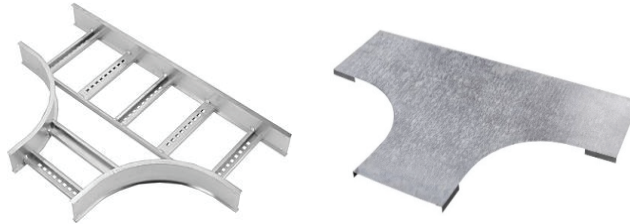

Horizontal Tee U - Ladder

Type		Size (mm)			Price (Rp)	
Electro Galvanize	Hotdip Galvanize	Width	Height	Thickness	Electro GV	Hotdip GV
FTUL-EG-10100-012	FTUL-HDG-10100-012	100	100	1.2	204,000	314,000
FTUL-EG-15100-012	FTUL-HDG-15100-012	150	100	1.2	221,000	339,000
FTUL-EG-20100-012	FTUL-HDG-20100-012	200	100	1.2	238,000	366,000
FTUL-EG-30100-012	FTUL-HDG-30100-012	300	100	1.2	274,000	419,000
FTUL-EG-40100-012	FTUL-HDG-40100-012	400	100	1.2	308,000	471,000
FTUL-EG-50100-012	FTUL-HDG-50100-012	500	100	1.2	366,000	560,000
FTUL-EG-60100-012	FTUL-HDG-60100-012	600	100	1.2	404,000	621,000

Cover Tee U & W - Ladder

Type		Size (mm)		Price (Rp)	
Electro Galvanize	Hotdip Galvanize	Width	Thickness	Electro GV	Hotdip GV
FCTUL-EG-100-012	FCTUL-HDG-100-012	100	1.2	142,000	179,000
FCTUL-EG-150-012	FCTUL-HDG-150-012	150	1.2	171,000	226,000
FCTUL-EG-200-012	FCTUL-HDG-200-012	200	1.2	204,000	276,000
FCTUL-EG-300-012	FCTUL-HDG-300-012	300	1.2	278,000	392,000
FCTUL-EG-400-012	FCTUL-HDG-400-012	400	1.2	364,000	521,000
FCTUL-EG-500-012	FCTUL-HDG-500-012	500	1.2	461,000	669,000
FCTUL-EG-600-012	FCTUL-HDG-600-012	600	1.2	566,000	832,000

Horizontal Tee W - Ladder

Specification :

- * Material : Hot Rolled Miled Steel Sheet (SPHC)
- * Thickness : 1.2mm
- * Radius : 300mm
- * Bend Angel : 90 degree
- * Plating : Electro Galvanize / Hotdip Galvanize

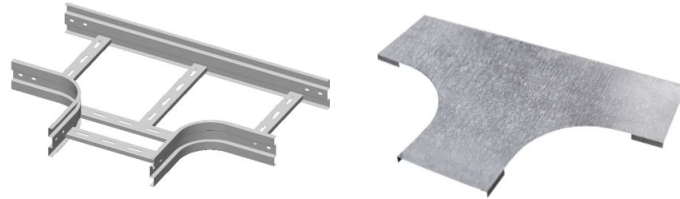

Horizontal Tee W - Ladder

Type		Size (mm)			Price (Rp)	
Electro Galvanize	Hotdip Galvanize	Width	Height	Thickness	Electro GV	Hotdip GV
FTWL-EG-10100-012	FTWL-HDG-10100-012	100	100	1.2	214,000	330,000
FTWL-EG-15100-012	FTWL-HDG-15100-012	150	100	1.2	232,000	356,000
FTWL-EG-20100-012	FTWL-HDG-20100-012	200	100	1.2	250,000	384,000
FTWL-EG-30100-012	FTWL-HDG-30100-012	300	100	1.2	288,000	440,000
FTWL-EG-40100-012	FTWL-HDG-40100-012	400	100	1.2	323,000	495,000
FTWL-EG-50100-012	FTWL-HDG-50100-012	500	100	1.2	384,000	588,000
FTWL-EG-60100-012	FTWL-HDG-60100-012	600	100	1.2	424,000	652,000

Cover Tee U & W - Ladder

Type		Size (mm)		Price (Rp)	
Electro Galvanize	Hotdip Galvanize	Width	Thickness	Electro GV	Hotdip GV
FCTUL-EG-100-012	FCTUL-HDG-100-012	100	1.2	142,000	179,000
FCTUL-EG-150-012	FCTUL-HDG-150-012	150	1.2	171,000	226,000
FCTUL-EG-200-012	FCTUL-HDG-200-012	200	1.2	204,000	276,000
FCTUL-EG-300-012	FCTUL-HDG-300-012	300	1.2	278,000	392,000
FCTUL-EG-400-012	FCTUL-HDG-400-012	400	1.2	364,000	521,000
FCTUL-EG-500-012	FCTUL-HDG-500-012	500	1.2	461,000	669,000
FCTUL-EG-600-012	FCTUL-HDG-600-012	600	1.2	566,000	832,000

Horizontal Cross U - Ladder

Specification :

- * Material : Hot Rolled Miled Steel Sheet (SPHC)
- * Thickness : 1.2mm
- * Radius : 300mm
- * Bend Angel : 90 degree
- * Plating : Electro Galvanize / Hotdip Galvanize

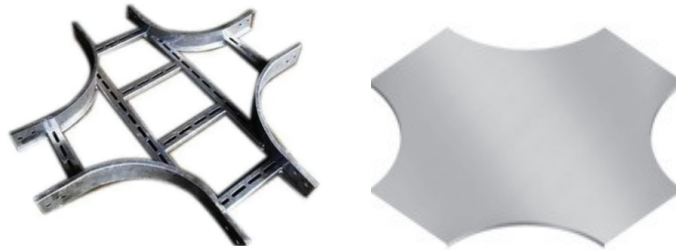

Horizontal Cross U - Ladder

Type		Size (mm)			Price (Rp)	
Electro Galvanize	Hotdip Galvanize	Width	Height	Thickness	Electro GV	Hotdip GV
FCUL-EG-10100-012	FCUL-HDG-10100-012	100	100	1.2	263,000	402,000
FCUL-EG-15100-012	FCUL-HDG-15100-012	150	100	1.2	280,000	429,000
FCUL-EG-20100-012	FCUL-HDG-20100-012	200	100	1.2	297,000	454,000
FCUL-EG-30100-012	FCUL-HDG-30100-012	300	100	1.2	330,000	509,000
FCUL-EG-40100-012	FCUL-HDG-40100-012	400	100	1.2	366,000	562,000
FCUL-EG-50100-012	FCUL-HDG-50100-012	500	100	1.2	425,000	652,000
FCUL-EG-60100-012	FCUL-HDG-60100-012	600	100	1.2	465,000	713,000

Cover Cross U & W - Ladder

Type		Size (mm)		Price (Rp)	
Electro Galvanize	Hotdip Galvanize	Width	Thickness	Electro GV	Hotdip GV
FCCUL-EG-100-012	FCCUL-HDG-100-012	100	1.2	234,000	286,000
FCCUL-EG-150-012	FCCUL-HDG-150-012	150	1.2	274,000	345,000
FCCUL-EG-200-012	FCCUL-HDG-200-012	200	1.2	314,000	408,000
FCCUL-EG-300-012	FCCUL-HDG-300-012	300	1.2	404,000	546,000
FCCUL-EG-400-012	FCCUL-HDG-400-012	400	1.2	504,000	700,000
FCCUL-EG-500-012	FCCUL-HDG-500-012	500	1.2	616,000	873,000
FCCUL-EG-600-012	FCCUL-HDG-600-012	600	1.2	738,000	1,058,000

Horizontal Cross W - Ladder

Specification :

- * Material : Hot Rolled Miled Steel Sheet (SPHC)
- * Thickness : 1.2mm
- * Radius : 300mm
- * Bend Angel : 90 degree
- * Plating : Electro Galvanize / Hotdip Galvanize

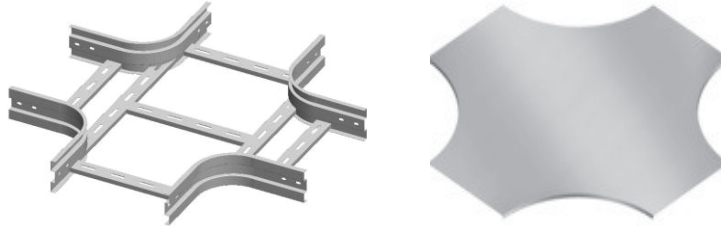

Horizontal Cross W - Ladder

Type		Size (mm)			Price (Rp)	
Electro Galvanize	Hotdip Galvanize	Width	Height	Thickness	Electro GV	Hotdip GV
FCWL-EG-10100-012	FCWL-HDG-10100-012	100	100	1.2	276,000	422,000
FCWL-EG-15100-012	FCWL-HDG-15100-012	150	100	1.2	294,000	450,000
FCWL-EG-20100-012	FCWL-HDG-20100-012	200	100	1.2	312,000	477,000
FCWL-EG-30100-012	FCWL-HDG-30100-012	300	100	1.2	347,000	534,000
FCWL-EG-40100-012	FCWL-HDG-40100-012	400	100	1.2	384,000	590,000
FCWL-EG-50100-012	FCWL-HDG-50100-012	500	100	1.2	446,000	685,000
FCWL-EG-60100-012	FCWL-HDG-60100-012	600	100	1.2	488,000	749,000

Cover Cross U & W - Ladder

Type		Size (mm)		Price (Rp)	
Electro Galvanize	Hotdip Galvanize	Width	Thickness	Electro GV	Hotdip GV
FCCUL-EG-100-012	FCCUL-HDG-100-012	100	1.2	234,000	286,000
FCCUL-EG-150-012	FCCUL-HDG-150-012	150	1.2	274,000	345,000
FCCUL-EG-200-012	FCCUL-HDG-200-012	200	1.2	314,000	408,000
FCCUL-EG-300-012	FCCUL-HDG-300-012	300	1.2	404,000	546,000
FCCUL-EG-400-012	FCCUL-HDG-400-012	400	1.2	504,000	700,000
FCCUL-EG-500-012	FCCUL-HDG-500-012	500	1.2	616,000	873,000
FCCUL-EG-600-012	FCCUL-HDG-600-012	600	1.2	738,000	1,058,000

Vertical Riser U - Ladder

Specification :

- * Material : Hot Rolled Miled Steel Sheet (SPHC)
- * Thickness : 1.2mm
- * Radius : 300mm
- * Bend Angel : 90 degree
- * Plating : Electro Galvanize / Hotdip Galvanize



INSIDE RISER



OUTSIDE RISER

Vertical Inside Riser U - Ladder

Type		Size (mm)			Price (Rp)	
Electro Galvanize	Hotdip Galvanize	Width	Height	Thickness	Electro GV	Hotdip GV
FIRUL-EG-10100-012	FIRUL-HDG-10100-012	100	100	1.2	131,000	201,000
FIRUL-EG-15100-012	FIRUL-HDG-15100-012	150	100	1.2	137,000	210,000
FIRUL-EG-20100-012	FIRUL-HDG-20100-012	200	100	1.2	143,000	219,000
FIRUL-EG-30100-012	FIRUL-HDG-30100-012	300	100	1.2	156,000	240,000
FIRUL-EG-40100-012	FIRUL-HDG-40100-012	400	100	1.2	168,000	260,000
FIRUL-EG-50100-012	FIRUL-HDG-50100-012	500	100	1.2	182,000	278,000
FIRUL-EG-60100-012	FIRUL-HDG-60100-012	600	100	1.2	194,000	299,000

Vertical Outside Riser U - Ladder

Type		Size (mm)			Price (Rp)	
Electro Galvanize	Hotdip Galvanize	Width	Height	Thickness	Electro GV	Hotdip GV
FORUL-EG-10100-012	FORUL-HDG-10100-012	100	100	1.2	131,000	201,000
FORUL-EG-15100-012	FORUL-HDG-15100-012	150	100	1.2	137,000	210,000
FORUL-EG-20100-012	FORUL-HDG-20100-012	200	100	1.2	143,000	219,000
FORUL-EG-30100-012	FORUL-HDG-30100-012	300	100	1.2	156,000	240,000
FORUL-EG-40100-012	FORUL-HDG-40100-012	400	100	1.2	168,000	260,000
FORUL-EG-50100-012	FORUL-HDG-50100-012	500	100	1.2	182,000	278,000
FORUL-EG-60100-012	FORUL-HDG-60100-012	600	100	1.2	194,000	299,000

Vertical Riser W - Ladder

Specification :

- * Material : Hot Rolled Miled Steel Sheet (SPHC)
- * Thickness : 1.2mm
- * Radius : 300mm
- * Bend Angel : 90 degree
- * Plating : Electro Galvanize / Hotdip Galvanize



INSIDE RISER



OUTSIDE RISER

Vertical Inside Riser W - Ladder

Type		Size (mm)			Price (Rp)	
Electro Galvanize	Hotdip Galvanize	Width	Height	Thickness	Electro GV	Hotdip GV
FIRWL-EG-10100-012	FIRWL-HDG-10100-012	100	100	1.2	138,000	211,000
FIRWL-EG-15100-012	FIRWL-HDG-15100-012	150	100	1.2	144,000	221,000
FIRWL-EG-20100-012	FIRWL-HDG-20100-012	200	100	1.2	150,000	230,000
FIRWL-EG-30100-012	FIRWL-HDG-30100-012	300	100	1.2	164,000	252,000
FIRWL-EG-40100-012	FIRWL-HDG-40100-012	400	100	1.2	176,000	273,000
FIRWL-EG-50100-012	FIRWL-HDG-50100-012	500	100	1.2	191,000	292,000
FIRWL-EG-60100-012	FIRWL-HDG-60100-012	600	100	1.2	204,000	314,000

Vertical Outside Riser W - Ladder

Type		Size (mm)			Price (Rp)	
Electro Galvanize	Hotdip Galvanize	Width	Height	Thickness	Electro GV	Hotdip GV
FORWL-EG-10100-012	FORWL-HDG-10100-012	100	100	1.2	138,000	222,000
FORWL-EG-15100-012	FORWL-HDG-15100-012	150	100	1.2	144,000	232,000
FORWL-EG-20100-012	FORWL-HDG-20100-012	200	100	1.2	150,000	242,000
FORWL-EG-30100-012	FORWL-HDG-30100-012	300	100	1.2	164,000	265,000
FORWL-EG-40100-012	FORWL-HDG-40100-012	400	100	1.2	176,000	287,000
FORWL-EG-50100-012	FORWL-HDG-50100-012	500	100	1.2	191,000	307,000
FORWL-EG-60100-012	FORWL-HDG-60100-012	600	100	1.2	204,000	330,000

Cover Vertical Riser U & W - Ladder

Specification :

- * Material : Hot Rolled Miled Steel Sheet (SPHC)
- * Thickness : 1.2mm
- * Radius : 300mm
- * Bend Angel : 90 degree
- * Plating : Electro Galvanize / Hotdip Galvanize

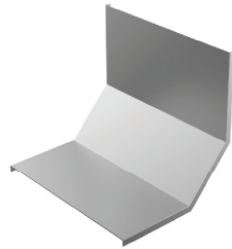

INSIDE RISER



OUTSIDE RISER

Cover Vertical Inside Riser U & W - Ladder

Type		Size (mm)		Price (Rp)	
Electro Galvanize	Hotdip Galvanize	Width	Thickness	Electro GV	Hotdip GV
FCIRL-EG-100-012	FCIRL-HDG-100-012	100	1.2	36,000	56,000
FCIRL-EG-150-012	FCIRL-HDG-150-012	150	1.2	51,000	76,000
FCIRL-EG-200-012	FCIRL-HDG-200-012	200	1.2	66,000	100,000
FCIRL-EG-300-012	FCIRL-HDG-300-012	300	1.2	93,000	142,000
FCIRL-EG-400-012	FCIRL-HDG-400-012	400	1.2	120,000	185,000
FCIRL-EG-500-012	FCIRL-HDG-500-012	500	1.2	150,000	227,000
FCIRL-EG-600-012	FCIRL-HDG-600-012	600	1.2	177,000	272,000

Cover Vertical Outside Riser U & W - Ladder

Type		Size (mm)		Price (Rp)	
Electro Galvanize	Hotdip Galvanize	Width	Thickness	Electro GV	Hotdip GV
FCORL-EG-100-012	FCORL-HDG-100-012	100	1.2	51,000	76,000
FCORL-EG-150-012	FCORL-HDG-150-012	150	1.2	70,000	106,000
FCORL-EG-200-012	FCORL-HDG-200-012	200	1.2	89,000	135,000
FCORL-EG-300-012	FCORL-HDG-300-012	300	1.2	129,000	196,000
FCORL-EG-400-012	FCORL-HDG-400-012	400	1.2	167,000	255,000
FCORL-EG-500-012	FCORL-HDG-500-012	500	1.2	207,000	316,000
FCORL-EG-600-012	FCORL-HDG-600-012	600	1.2	244,000	375,000

Reducer U - Ladder

Specification :

* Material : Hot Rolled Miled Steel Sheet (SPHC)

* Thickness : 1.2mm

* Length : 600mm

* Plating : Electro Galvanize / Hotdip Galvanize

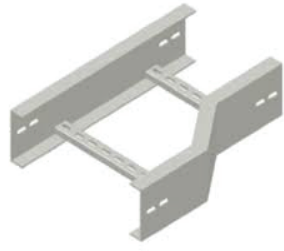

LEFT REDUCER



RIGHT REDUCER



STRAIGHT REDUCER

Reducer U - Ladder

Type		Size (mm)			Price (Rp)	
Electro Galvanize	Hotdip Galvanize	Width	Height	Thickness	Electro GV	Hotdip GV
FRUL-EG-1550-012	FRUL-HDG-1550-012	150	100	1.2	112,000	171,000
FRUL-EG-2050-012	FRUL-HDG-2050-012	200	100	1.2	117,000	177,000
FRUL-EG-3050-012	FRUL-HDG-3050-012	300	100	1.2	123,000	188,000
FRUL-EG-4050-012	FRUL-HDG-4050-012	400	100	1.2	131,000	201,000
FRUL-EG-5050-012	FRUL-HDG-5050-012	500	100	1.2	140,000	213,000
FRUL-EG-6050-012	FRUL-HDG-6050-012	600	100	1.2	148,000	226,000

Cover Reducer U - Ladder

Type		Size (mm)		Price (Rp)	
Electro Galvanize	Hotdip Galvanize	Width	Thickness	Electro GV	Hotdip GV
FRCLU-EG-150-012	FRCLU-HDG-150-012	150	1.2	58,000	87,000
FRCLU-EG-200-012	FRCLU-HDG-200-012	200	1.2	72,000	110,000
FRCLU-EG-300-012	FRCLU-HDG-300-012	300	1.2	104,000	160,000
FRCLU-EG-400-012	FRCLU-HDG-400-012	400	1.2	137,000	209,000
FRCLU-EG-500-012	FRCLU-HDG-500-012	500	1.2	168,000	257,000
FRCLU-EG-600-012	FRCLU-HDG-600-012	600	1.2	201,000	305,000

Reducer W - Ladder

Specification :

- * Material : Hot Rolled Miled Steel Sheet (SPHC)
- * Thickness : 1.2mm
- * Length : 600mm
- * Plating : Electro Galvanize / Hotdip Galvanize



LEFT REDUCER



RIGHT REDUCER



STRAIGHT REDUCER

Reducer W - Ladder

Type		Size (mm)			Price (Rp)	
Electro Galvanize	Hotdip Galvanize	Width	Height	Thickness	Electro GV	Hotdip GV
FRWL-EG-1550-012	FRWL-HDG-1550-012	150	100	1.2	118,000	180,000
FRWL-EG-2050-012	FRWL-HDG-2050-012	200	100	1.2	123,000	186,000
FRWL-EG-3050-012	FRWL-HDG-3050-012	300	100	1.2	129,000	197,000
FRWL-EG-4050-012	FRWL-HDG-4050-012	400	100	1.2	138,000	211,000
FRWL-EG-5050-012	FRWL-HDG-5050-012	500	100	1.2	147,000	224,000
FRWL-EG-6050-012	FRWL-HDG-6050-012	600	100	1.2	155,000	237,000

Cover Reducer W - Ladder

Type		Size (mm)		Price (Rp)	
Electro Galvanize	Hotdip Galvanize	Width	Thickness	Electro GV	Hotdip GV
FRCLW-EG-150-012	FRCLW-HDG-150-012	150	1.2	58,000	87,000
FRCLW-EG-200-012	FRCLW-HDG-200-012	200	1.2	72,000	110,000
FRCLW-EG-300-012	FRCLW-HDG-300-012	300	1.2	104,000	160,000
FRCLW-EG-400-012	FRCLW-HDG-400-012	400	1.2	137,000	209,000
FRCLW-EG-500-012	FRCLW-HDG-500-012	500	1.2	168,000	257,000
FRCLW-EG-600-012	FRCLW-HDG-600-012	600	1.2	201,000	305,000

Accessories Cable TRAY & Ladder

Specification :

* Material : Hot Rolled Miled Steel Sheet (SPHC)

* Thickness : 1.2mm

* Plating : Electro Galvanize / Hotdip Galvanize

Note : * Jointing Price Include bolts, nut, ring

Jointing U - TRAY

Type		Size (mm)	Price / pcs (Rp)	
Electro Galvanize	Hotdip Galvanize		Electro GV	Hotdip GV
JUT-EG-50	JUT-HDG-50	50	12,000	18,000
JUT-EG-100	JUT-HDG-100	100	20,000	29,000



Jointing C - TRAY

Type		Size (mm)	Price / pcs (Rp)	
Electro Galvanize	Hotdip Galvanize		Electro GV	Hotdip GV
JCT-EG-50	JCT-HDG-50	50	12,000	18,000
JCT-EG-100	JCT-HDG-100	100	20,000	29,000



Jointing U - Ladder

Type		Size (mm)	Price / pcs (Rp)	
Electro Galvanize	Hotdip Galvanize		Electro GV	Hotdip GV
JUL-EG-50	JUL-HDG-50	50	12,000	18,000
JUL-EG-100	JUL-HDG-100	100	20,000	29,000



Jointing W - Ladder

Type		Size (mm)	Price / pcs (Rp)	
Electro Galvanize	Hotdip Galvanize		Electro GV	Hotdip GV
JWL-EG-100	JWL-HDG-100	100	18,000	27,000



Stand Plate

Type		Size (mm)	Price / pcs (Rp)	
Electro Galvanize	Hotdip Galvanize		Electro GV	Hotdip GV
SPTL-EG-50	SPTL-HDG-50	50	52,000	56,000
SPTL-EG-100	SPTL-HDG-100	100	62,000	78,000

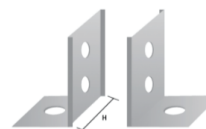

Wall Bracket

Type		Size (mm)	Price / pcs (Rp)	
Electro Galvanize	Hotdip Galvanize		Electro GV	Hotdip GV
WBTL-EG-50	WBTL-HDG-50	50	33,000	43,000
WBTL-EG-100	WBTL-HDG-100	100	44,000	56,000



Accessories Cable TRAY & Ladder

Specification :

* Material : Hot Rolled Miled Steel Sheet (SPHC)

* Thickness : 1.8mm

* Plating : Electro Galvanize / Hotdip Galvanize

Bracket

Type		Size (mm)	Price / pcs (Rp)	
Electro Galvanize	Hotdip Galvanize		Electro GV	Hotdip GV
FBTL-EG-50	FBTL-HDG-50	50	41,000	53,000
FBTL-EG-100	FBTL-HDG-100	100	56,000	71,000
FBTL-EG-150	FBTL-HDG-150	150	70,000	90,000
FBTL-EG-200	FBTL-HDG-200	200	85,000	108,000
FBTL-EG-250	FBTL-HDG-250	250	100,000	127,000
FBTL-EG-300	FBTL-HDG-300	300	114,000	145,000
FBTL-EG-400	FBTL-HDG-400	400	142,000	183,000
FBTL-EG-500	FBTL-HDG-500	500	172,000	220,000
FBTL-EG-600	FBTL-HDG-600	600	176,000	225,000



Hanger Beam

Type		Size (mm)	Price / pcs (Rp)	
Electro Galvanize	Hotdip Galvanize		Electro GV	Hotdip GV
FHBTL-EG-50	FHBTL-HDG-50	50	17,000	21,000
FHBTL-EG-100	FHBTL-HDG-100	100	22,000	28,000
FHBTL-EG-150	FHBTL-HDG-150	150	30,000	37,000
FHBTL-EG-200	FHBTL-HDG-200	200	36,000	47,000
FHBTL-EG-250	FHBTL-HDG-250	250	44,000	54,000
FHBTL-EG-300	FHBTL-HDG-300	300	52,000	64,000
FHBTL-EG-400	FHBTL-HDG-400	400	58,000	72,000
FHBTL-EG-500	FHBTL-HDG-500	500	63,000	79,000
FHBTL-EG-600	FHBTL-HDG-600	600	80,000	100,000

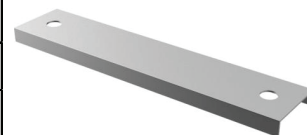

Accessories Cable TRAY & Ladder

Specification :

* Material : Hot Rolled Miled Steel Sheet (SPHC)

* Thickness : 1.8mm

* Plating : Electro Galvanize / Hotdip Galvanize

Hanger Rod

Type		Size	Price / pcs (Rp)	
Electro Galvanize	Hotdip Galvanize		Electro GV	Hotdip GV
HRTL-EG-3/8	HRTL-HDG-3/8	3/8" X 1M		



Hanger Clevis

Type		Size (mm)	Price / pcs (Rp)	
Electro Galvanize	Hotdip Galvanize		Electro GV	Hotdip GV
HCTL-EG-40	HCTL-HDG-40	40 X 45	31,000	40,000



Hold Down Clamp

Type		Size (mm)	Price / pcs (Rp)	
Electro Galvanize	Hotdip Galvanize		Electro GV	Hotdip GV
HDTL-EG-50	HDTL-HDG-50	50	7,800	11,400
HDTL-EG-100	HDTL-HDG-100	100	11,700	14,000



Angel Connector

Type		Size (mm)	Price / pcs (Rp)	
Electro Galvanize	Hotdip Galvanize		Electro GV	Hotdip GV
ACTL-EG-50	ACTL-HDG-50	50	15,600	19,000
ACTL-EG-100	ACTL-HDG-100	100	22,000	28,000

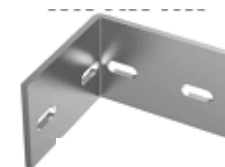

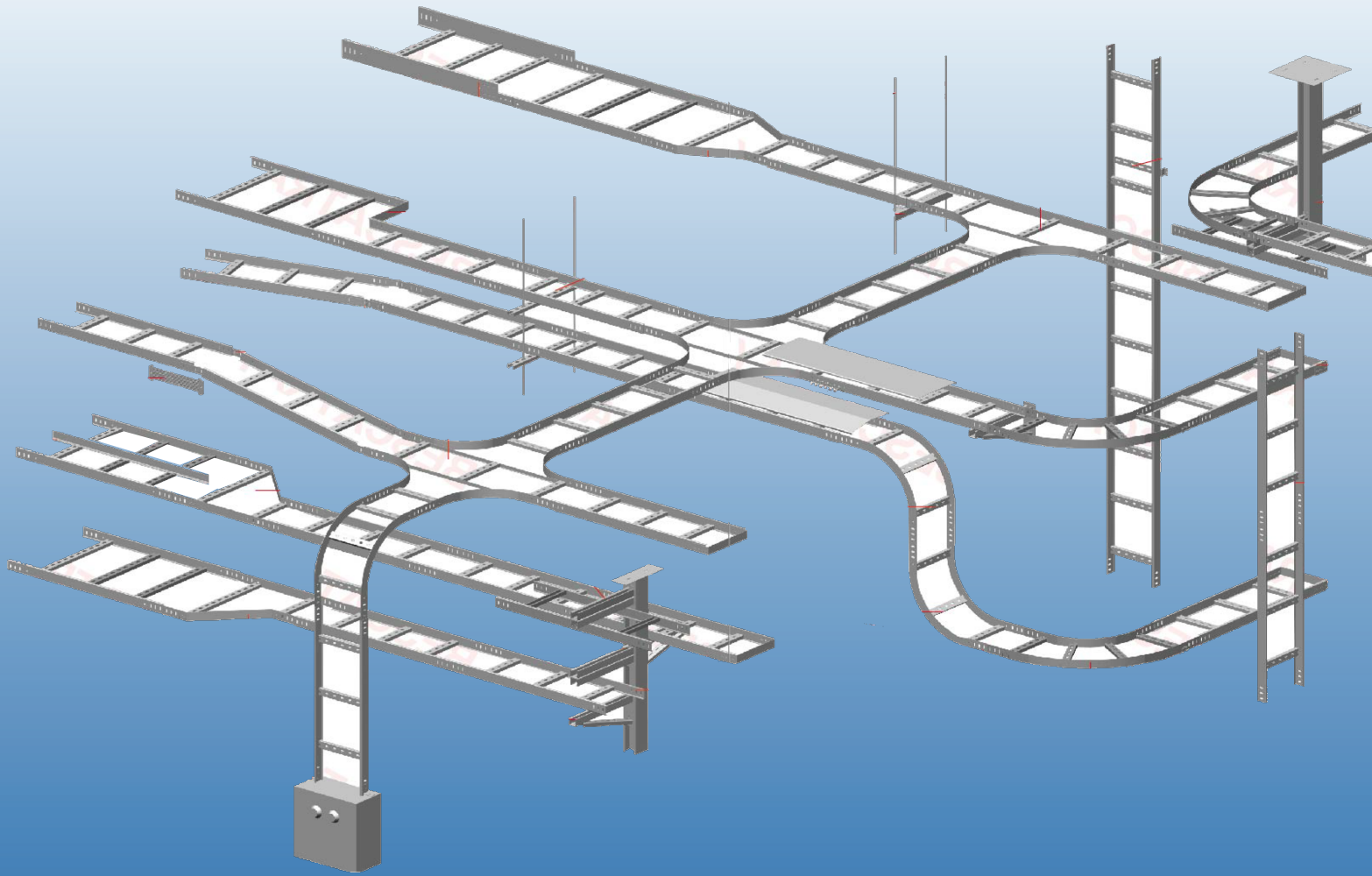

CABLE MANAGEMENT

